



2014 | A5

Audi of America
Audiusa.com
Facebook.com/Audi

AoA1414204

Note: A word about this brochure. Audi of America, Inc., believes the specifications in this brochure to be correct at the time of printing. However, specifications, standard equipment, options, fabrics, and colors are subject to change without notice. Some equipment may be unavailable when your vehicle is built. Please ask your dealer for advice concerning current availability of standard and optional equipment, and your dealer will verify that your vehicle will include the equipment you ordered. Vehicles in this brochure are shown with optional equipment. See your dealer for complete details on the Audi New Vehicle Limited Warranty, twelve-year limited warranty against corrosion perforation, and Audi 24/7 Roadside Assistance. (Roadside assistance coverage provided by Road America in the U.S. Certain conditions apply; see your dealer for details.) Tires supplied by various manufacturers. "Audi," all model names, "Audi connect," "Audi Sport," "Audi ultra," "FSI," "MMI," "multitronic," "quattro," "Sideguard," "Singleframe" and the Singleframe grille design, "S line," "TFSI," "Truth in Engineering," and the four rings logo are registered trademarks of AUDI AG. "Alcantara" is a registered trademark of Alcantara S.p.A. "Bang & Olufsen" is a registered trademark of Bang & Olufsen. The BLUETOOTH word mark and logos are owned by the Bluetooth SIG, Inc., and any use of such marks by AUDI AG is under license. "Google," "Google Earth" and "Google Voice" are trademarks of Google Inc. "HD Radio" and the HD Radio logo are proprietary trademarks of iBiquity Digital Corporation. "Homelink" is a registered trademark of Johnson Controls Technology Company. "iPod" is a registered trademark of Apple Inc. "SiriusXM" and all related marks and logos are trademarks of Sirius XM Radio Inc. and its subsidiaries. "TDI" is a registered trademark of Volkswagen AG. "Wi-Fi" is a trademark of the Wi-Fi Alliance. All other trademarks are the property of their respective owners. Some European models shown.

© 2013 Audi of America, Inc. Printed in U.S.A.

A5

Audi A5 Coupe | A5 Cabriolet

Audi
Truth in Engineering 

It's Audi because

we're driven by human achievement.

More than just cars, more than just performance. Audi is about the nature of perception, determining how people will respond to and interact with innovative design. It's about applied physics, how things glide through the air and overcome inertia through the application of power, acceleration and exhilaration.¹ It's about artistry, and the way materials elicit a tactile response and provoke an emotional response. It's

chemistry and how it bonds with you. It's poetry written in metal, engineering and design. Audi is the product of learning and application of knowledge. At its best, it is a dynamic example of what humans can create when they are vested in creating something better and bolder. So Audi is not just about cars. But then again, of course, it's also about cars.



¹ Obey all speed and traffic laws.

It's Audi because

luxury tells the ornate, the garish, the gilded and the over-indulgent...

→ Ornate elements don't help to tell time →

→ Gilt prone to dull →

→ Unnecessary weight means mantle and not wall →



1 Always pay careful attention to the road, and do not drive while distracted. The features and technologies discussed above are optional, may require an additional subscription with separate terms and conditions, and should be used only when it is safe and appropriate. The Wi-Fi® hotspot feature is intended for passenger use only. 2 Features and technologies listed will not be available on all models.

...time's up.

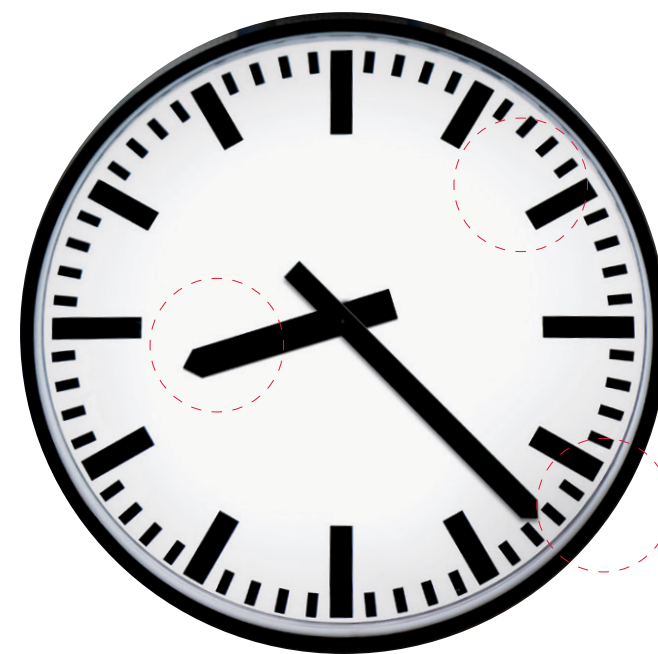

← Precise design and improved accuracy ←

← Easily processed information at a glance ←

← Design allows for hanging, for improved viewing angle ←

Excessive luxury is not our goal. But we feel that luxury doesn't mean "more," it means "proper." Proper design, proper fit, proper precision—what Audi thinks of as design purity. Our engineers and designers know that a baroque clock won't tell time any better than a streamlined one, and all the distractions that surround it actually detract from the purpose of the clock itself. Unless, of course, the purpose is just to be noticed, instead of used to its greatest

potential. We think the real purpose of design is simplicity, elegantly rendered. We think you'll see and feel that concept throughout our Audi models. In the clean design lines of the exterior, the streamlined dash, and Audi MMI® interface. In our intuitive available Audi connect®¹, the seamless fit and finish of our materials and the unmistakable look of our Audi Singleframe® grille.² They all work in concert for a pure aesthetic of timeless taste and precision.

It's Audi because

our reputation hinges on the quality of things you don't see.

It's said that when one door closes, another one opens. It sounds as if whoever said it spent some time at an Audi research and development facility. After all, while you'll open and close the door on your Audi thousands of times without thinking about it, we've obsessed about it for you, in detail. Not just about the reliability of it opening and closing, obviously, but on the proper weight that will make it more pleasing to close. What it should sound like when it is shut. How the locks should click when they are engaged. The optimal acoustic placement for the speaker port. There are the

hinges too, of course. And the door itself, which is designed to take the brunt of side-collision impacts, along with several dozen other considerations that we take into account when designing our doors (to say nothing of the countless other components, processors, sensors, features and the inner workings most people will never see). Our doors are more than a symbol of welcoming you into your vehicle, they are products of Audi engineering, and our reputation hinges on them as much as our hinges help support the door.

Acoustic enhancements

We spend countless hours listening, so you don't have to. By using soft-mounts on our window regulator, or a sound absorber backing within the door cavity itself, as well as a simple foam liner on our door-release cable, Audi engineers have nearly eliminated all of the ambient noise associated with other less-than-acute manufacturing practices.

Award-winning design

When Audi engineers set out to build the perfect door, they had one very important goal—lighten the load. By using fully pressed aluminum doors, the weight of the Audi A6 door structure was reduced by an astonishing 44 lb, compared to the previous model. This feat, combined with the strength of its door hinges and ability to retain all of its mechanical, safety and infotainment features, is why it won the Doors and Closures Innovation Award.

Speaker placement and enclosure

We work with our partners to select optimal placement of our speakers, a vital aspect of our door design, in order to deliver the most engaging and extraordinary sound you can find in the automotive space. Woofers use a specialized lightweight and ported enclosure to ensure optimum low-frequency reproduction.

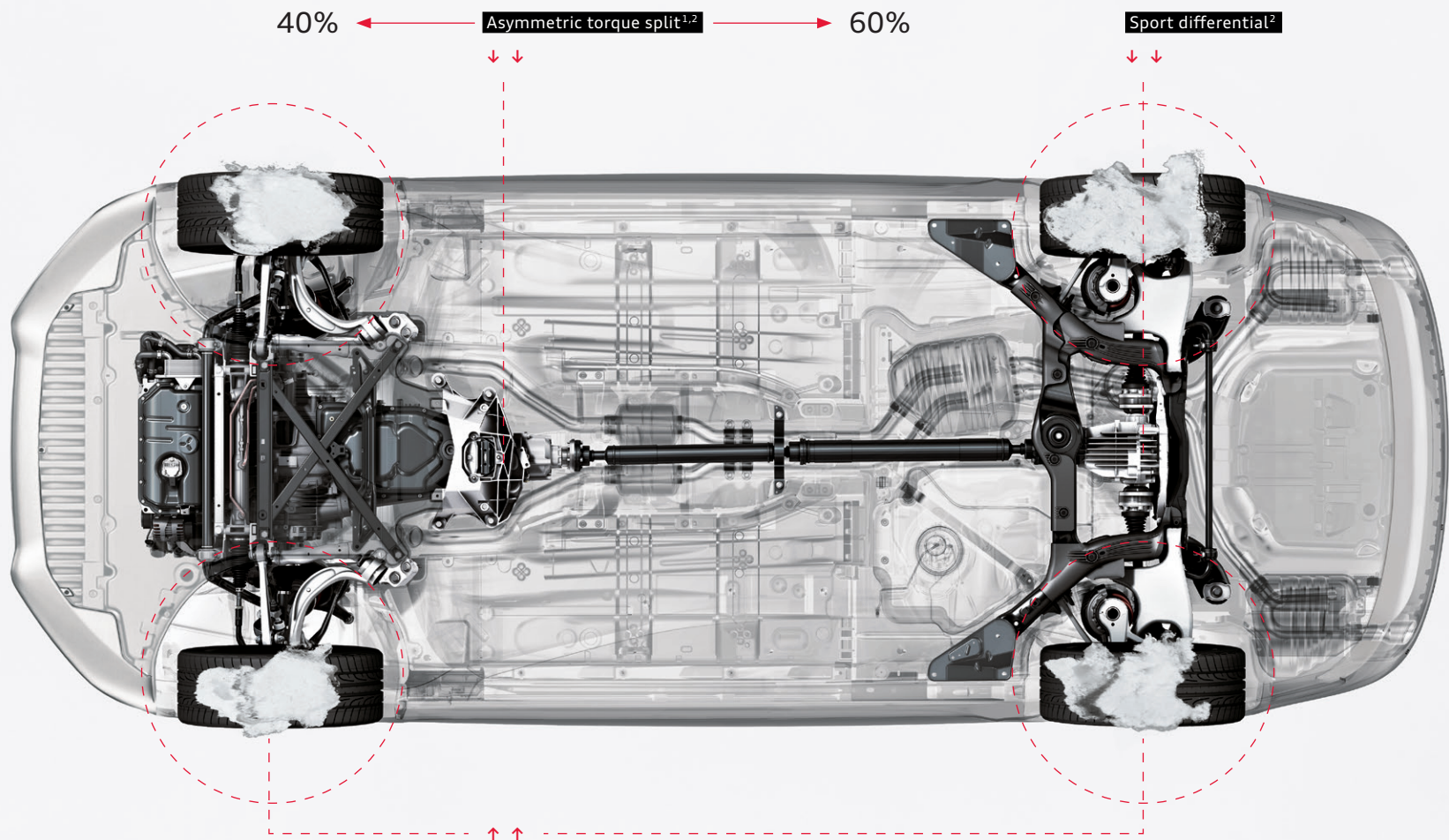

Torque vectoring²

You'll find truth in your corner. Torque vectoring is a handling feature so advanced that it seems to respond to your impulses even before you turn the steering wheel. An evolution of cross-axle lock, this system works within the Audi quattro® all-wheel drive system while utilizing Electronic Stability Control (ESC) and the Anti-lock Braking System (ABS) to help sense reduced load or wheel-spin on the inside cornering tire, helping to make turns smoother and more responsive.²



It's Audi because

conditions don't have to dictate how you stick it to the road.

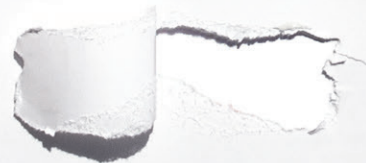

As you can see, we've always felt that the best ideas are the ones that stick. And nowhere is that more true than with Audi quattro® all-wheel drive. Since 1980, we've been stuck on articulating an expanding vision of what progressive all-wheel drive technology can deliver. We didn't simply look at it as something to use in poor conditions, but rather as a performance technology that's built to handle roads from the Alps to the autobahn—and points beyond. You've seen quattro® capabilities in the way we dominated the World Rally Championship for years, in the grip you have in inclement weather,

and in the variable rear-wheel-biased power you enjoy in good conditions.¹ For more than 30 years and with five million quattro® systems installed in Audi vehicles, we have continued to refine the technology, developing a rear sport differential to help maximize performance, and torque vectoring to assist with cornering traction while helping to improve handling.² We boldly stuck to what worked while the world was trying to catch up, and we built on our vision by adding to a gripping heritage of Audi Sport® performance.

European model shown with optional equipment. 1 Torque split ratio will vary from model to model. 2 Optional features. Features and technologies listed will not be available on all models.

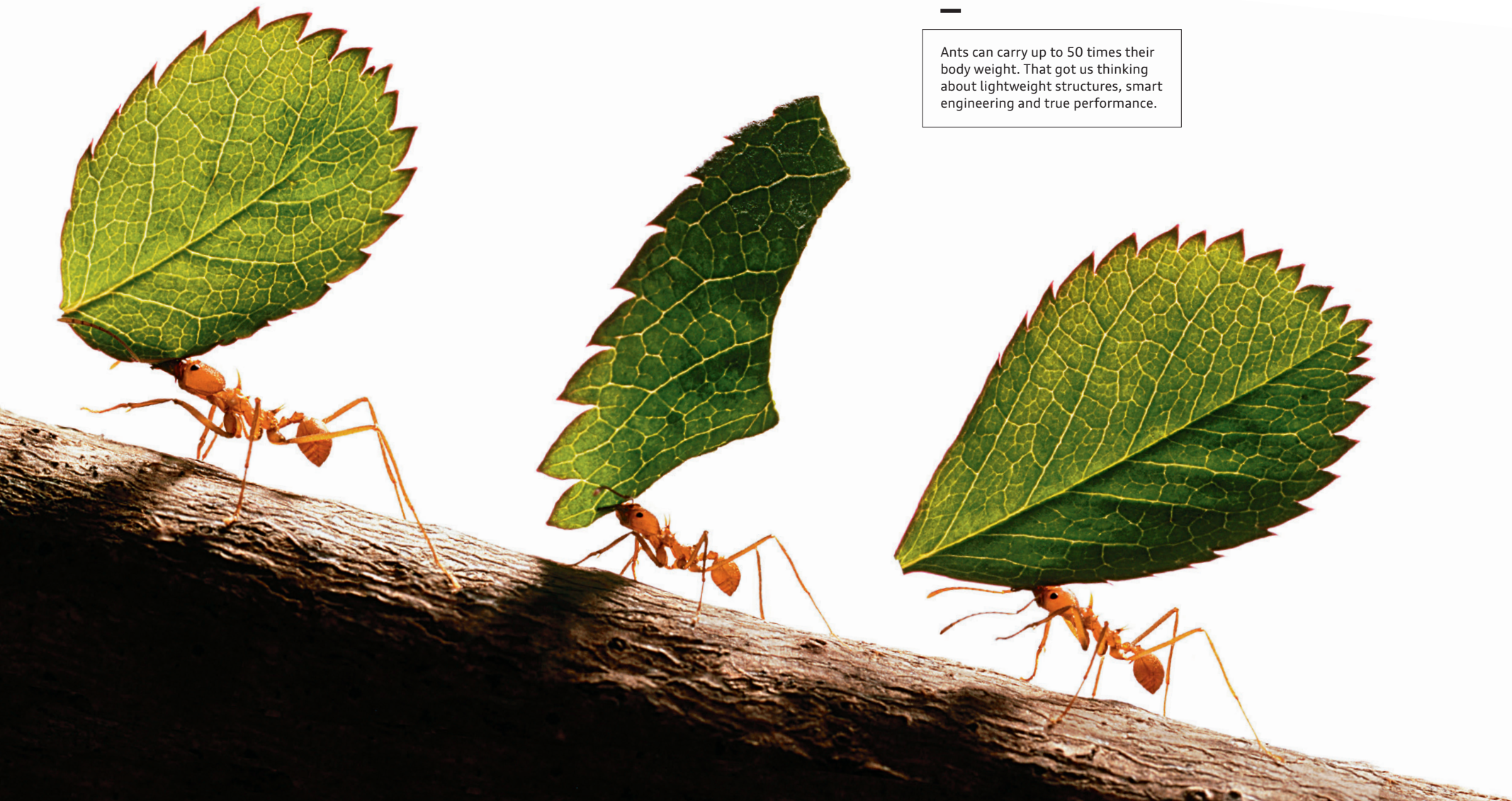

—

Ants can carry up to 50 times their body weight. That got us thinking about lightweight structures, smart engineering and true performance.

It's Audi because

power is measured by strength, not size.

It's perfectly fine for us to admit that other engines have more cylinders, have more horsepower and have larger displacements. It's just that we've made our engines lighter and more efficient than others, to optimize what we call power density.¹ Because anyone who has driven an Audi knows unmistakable power when they feel it. It means strength that pulses with torque at the moment of acceleration, provides a true, quick response as you change lanes, and turns the most routine cloverleaf into a joyful application of performance

handling. Sure, we love hitting the throttle and feeling the thrust of acceleration;² but we also want our drivers to experience the balance and precision of Audi engineering. From the A3 to our track-bred line of Audi performance cars, we are in the business of engineering emotion using more compact engines that concentrate power, while using less weight to your advantage, helping improve handling to the point where others just feel heavy.

TDI®

A turbocharged, fuel-sipping variant, our TDI® clean diesel engine delivers uncompromising Audi performance with bold efficiency.¹ Yes, it gets better mileage per gallon than comparable gasoline engines, but it also produces more low-end torque, which is best expressed in the elasticity you have when passing in the 30- to 60-mph range.

FSI®

The Audi FSI direct injection fuel management and delivery system directly injects fuel into the combustion chambers at precisely managed times and depths. What that means for drivers is that a fully homogenized intake charge helps increase power while also reducing fuel consumption and emissions, making efficiency more powerful.¹

TFSI®

At Audi, TFSI represents a combination of two of the brand's core areas of expertise—direct injection and forced induction. By adding forced induction (turbocharging or supercharging) to Audi FSI direct injection, the pressurized intake charge is cooled by directly injected fuel, thus achieving efficiency and performance combined with higher compression ratios—previously only attainable by naturally aspirated engines.¹

¹ See www.fueleconomy.gov for EPA estimates. Your mileage will vary. ² Obey all speed and traffic laws.



Mobile Wi-Fi® hotspot

Provides high-speed connectivity for up to eight passenger devices through an onboard wireless hub.^{1,3}



City events

Get information about current events, exciting locations and places of interest at your travel destination, current location or other chosen location instantly.³



myAudi features

Plan travel from your personal computer. Send your desired destinations to your vehicle ahead of time and access your route from your vehicle later.³



Google Voice™ Local Search

Simply tell your Audi what you are in the mood for, then let the cloud-processing power of Google™ speech recognition interpret your request and bring up a list of destinations in the area of your choice.³



Google Earth™ with 3D satellite imagery

With Google Earth™ integration, you'll enjoy 3D satellite imagery, including Google Maps Street View, displayed right on the Audi MMI display.³

It's Audi because

spicy chicken is your destiny.

If you are craving an Audi, we know your tastes run a little bold. But what happens when you crave spicy chicken, or a nice vindaloo, or some pepper salsa? Well, in your Audi, you can just say the word, and we'll help find the heat. With available Audi connect®,¹ we've developed a way to seek out your destiny, even if that's just finding the closest gas station, or the best hotel. Audi connect integrates Google™ technolo-

gies, like Google Earth™ with 3D satellite imagery, with Audi MMI® Navigation plus.² It also provides Wi-Fi® connectivity for up to eight passenger devices to help you stay informed. Check local fuel prices, weather information and, yes, the closest Szechuan restaurant using Google™ Local Search capabilities. Think of where that might take you.^{1,3}

1. Always pay careful attention to the road, and do not drive while distracted. The features and technologies discussed above are optional, may require an additional subscription with separate terms and conditions, and should be used only when it is safe and appropriate. The Wi-Fi® hotspot feature is intended for passenger use only. 2. Audi MMI® Navigation plus depends on signals from the worldwide Global Positioning Satellite network. The vehicle's electrical system and existing wireless and satellite technologies must be available and operating properly for the system to function. The system is designed to provide you with suggested routes in locating addresses, destinations and other points of interest. Changes in street names, construction zones, traffic flow, points of interest and other road system changes are beyond the control of Audi of America, Inc. Complete detailed mapping of lanes, roads, streets, toll roads, highways, etc., is not possible, therefore you may encounter discrepancies between the mapping and your actual location. Please rely on your individual judgment in determining whether or not to follow a suggested Audi MMI® Navigation plus route. Periodically mapping updates will be available for purchase at an additional cost. Consult your dealer or call 1-800-FOR-AUDI for details. 3. Optional features. Features and technologies listed will not be available on all models.





Elephant skull

How nature solved the apparent conundrum of an elephant's skull didn't escape the notice of Heinrich Timm, the longtime lead engineer for Audi. The weight of the tusks and the general size of an elephant's head would seem to make it impossible for the animal to actually be able to carry it. But the design genius behind the elephant's skull is actually to make it lightweight, yet sturdy. Its predominantly hollow design is buffered by thin, connective bone walls, which act as strong, weight-bearing cells. Audi designers used that idea when building our aluminum and steel structures. Reducing weight, yet enabling strength.

Aluminum



Our large aluminum castings are a telling example of Audi ultra® lightweight technology. Primarily used in high-stress areas, these multifunctional castings achieve exceptional rigidity while also allowing for freedom of design, all while remaining extremely lightweight.¹

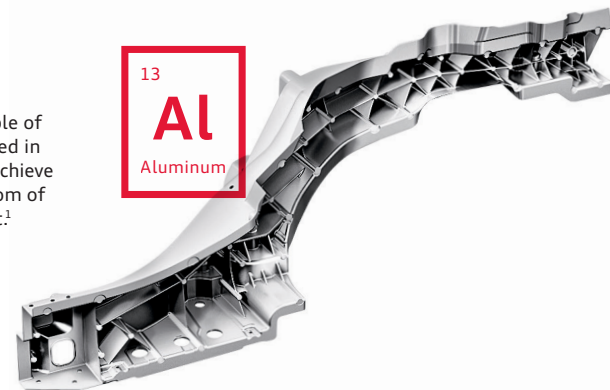

It's Audi because

the elegant structure of nature becomes a blueprint of efficiency.

It seems strange to say that, while we build strong, complex and high-performing machines, we're naturalists at heart. Then again, it might not be that unusual, seeing how nature itself builds strong, complex and high-performing machines as well. When we developed the thinking behind our Audi ultra® lightweight technology initiative, we knew that nature would serve as an inspiration to greater structural efficiency. Take the structure of the elephant skull pictured here. It has to be lightweight, yet capable of carrying a heavy load. It's porous, but its structure is such that it enhances its stability and

strength. We do the same, for example, with aluminum. Positioned one way, aluminum materials can be flexible. Positioned another, they are strong and rigid, and give better support. We also looked to bamboo, which is strong at the conjoined areas (nodes), and flexible along its stem. Our designs allow for both rigidity and flexibility where each is most needed, and for efficiency overall.² As we continue to develop strategies to improve the performance aspects and efficiency of our vehicles, we don't shy away from the world around us.² We boldly engage it even closer still.

¹ Features and technologies listed will not be available on all models. ² See www.fueleconomy.gov for EPA estimates. Your mileage will vary.



It's Audi because

you I.D. our eye queue.

Even if you knew nothing about Audi, you'd still know if you were staring at one because we are unafraid to stare back. In fact, that exchange might just be love at first sight. That's how much our iconic LED lighting technology stands out from the pack. So we had the bright idea to make our LED daytime running lights look even more in-

tense. Now featuring a solid, sleek diode design that ingeniously reinvents our signature style, Audi LED lighting technology is once again unmistakably ours. It is an efficient, beautiful way to help you see and be seen during dawn and dusk. Look deeply into our eyes, and you'll know the truth of our attraction.¹

¹ Features listed are available on all models.



1 Steering wheel

The Audi steering wheel is both an ergonomic command center and an elegant structure of performance. Easily accessed controls on the wheel give you control over your MMI® and Audi connect®, while it is designed to give you effortless access to visual information on the driver information display.^{1,2}

2 Audi connect and MMI

Simple voice or finger motions can help you access information, music and BLUETOOTH® enabled features.^{1,2}

3 Electromechanical parking brake

Properly positioned in the center console, the parking brake control is another small, but telling, design cue for Audi. The parking brake control serves to enhance the overall ergonomic intent of the vehicle, while delivering easy access and simple functionality.¹

4 Bang & Olufsen® Advanced Sound System

With retractable acoustic lenses and speakers positioned around the Audi specifically to optimize sound quality, Bang & Olufsen® engineers have worked tirelessly with Audi sound designers to create an immersive audio experience.¹

It's Audi because

optimized design makes your commute shine a little brighter.

Get away from it all, every day, around 6 p.m., when you leave work and enter into a customized world that's completely dedicated to your comfort and entertainment. This place, of course, is the cabin of your Audi. Optimized luxury, designed by committed craftsmen who have you in mind when they choose the leather seating surfaces, create the adjustable seats or provide the refinement of ergonomic design and a more intuitive MMI. There are small touches that help simplify the overall design, like a

stylish contoured electromechanical parking brake at the foot of the center stack and an available Bang & Olufsen® retracting acoustic lens, perfectly positioned for richly detailed sound quality. And there are large statements, like a steering wheel with easily accessed controls to help you feel comfortably at ease. It is your Audi interior, where you leave the world behind, even when the world might seem in front of you on the way home.¹

1 Optional features. Features and technologies listed will not be available on all models. 2 Always pay careful attention to the road, and do not drive while distracted. The features and technologies discussed above are optional, may require additional subscription with separate terms and conditions, and should be used only when it is safe and appropriate. The Wi-Fi hotspot feature is intended for passenger use only.

It's Audi because

it's as if we have SPF for seats.

With innovative pigments and dyes, the Thermocool technology Audi uses in select leather seating surfaces just might prevent that startling moment on hot sunny days. You know the one, when you sit down and feel, immediately, an intense, searing feeling on your leg. Now you can keep your cool. This supple leather doesn't heat up as

much in direct sunlight as traditional leather does. In fact, the difference between untreated leather and the temperature on your seat treated with Thermocool can be as much as 86°. A perfect solution for your Audi A5 Cabriolet, TT Roadster or R8 Spyder, Thermocool technology is Audi to its core. Because it keeps its cool, you can keep yours.

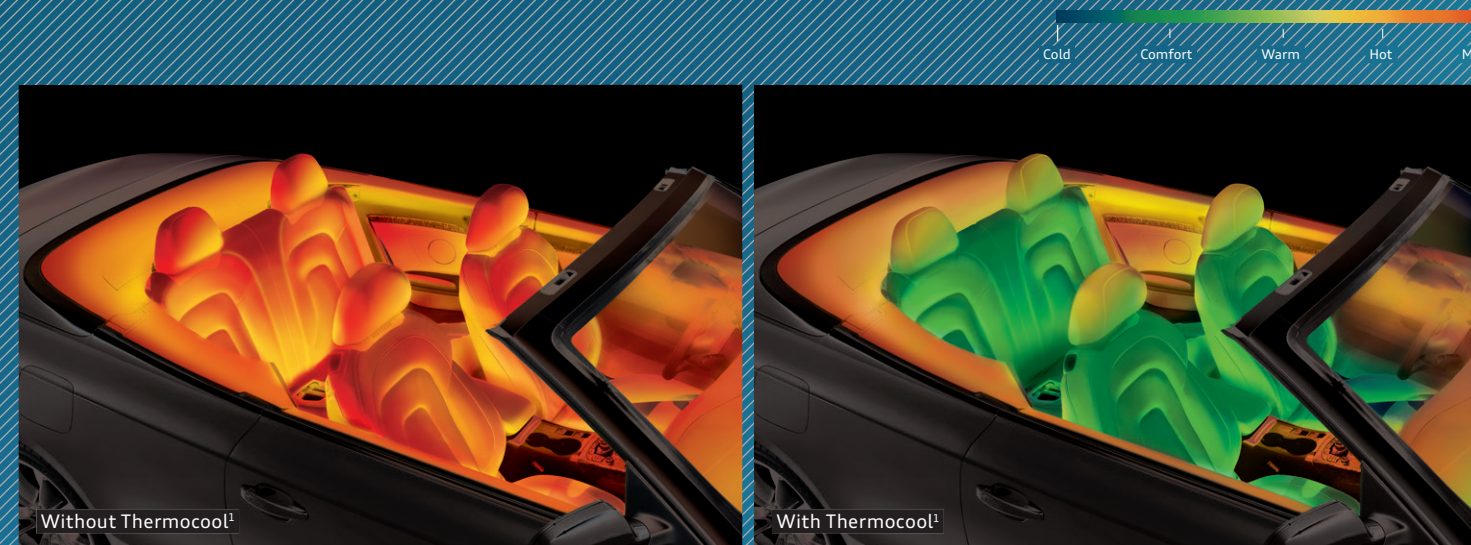

¹ Images shown are for dramatization purposes only.

AUDI

The story of our collection of obsessions.

Precision. Design. Vision. These are the kind of attributes that we deliver as a company, the kind of passions that go way past getting you from point A to point B. That's because Audi knows that how you get to your destination is only part of the story. And so it is with us as a luxury brand. Our obsessions are our commitments, a collection of inspirations that make up our core truth: That from a foundation of brilliant engineering, we craft more than great vehicles—we tell great stories.

A5

Stepping away from convention.

You're about to transition from a macro view of Audi as a brand to the specifics of a Coupe and Cabriolet built to shift paradigms. Climb into the Audi A5, and you'll never want to drive anything else. Its iconic design is a powerful expression of strength, our way of standing out above the fray. The A5 makes a statement as bold as it is exciting to drive.

BECAUSE



Design

We do not follow design trends. We set them.

**We dared, while
the others watched.**

Nothing captures the imagination like an automobile that turns heads. That's why every double-take the Audi A5 gets is a testament to the adventurous spirit and bold sensibilities of both Audi designers and drivers alike. And that's why there is such a strong response to the sophisticated lines that sweep across the A5, as well as to the seductive punch of its acceleration. Everything we build into the A5, even the way we hide the B-pillar, is meant to give it a sense of movement. Something you might notice even when it is standing still. Heads turn, because we pay attention to every detail, from the precision handling to the striking headlights with available LED daytime running light technology, which seem to stare back at the attention of onlookers. Available in Coupe and Cabriolet, there is an A5 crafted to provoke emotion, and maybe even a little envy, in every person who looks as you drive by.



Enlighten

Shedding a new light on illumination just happened to be a design boon.

Sometimes standing on the edge gives you the greatest view.

It may be, as has been suggested, that the Audi A5 is a polarizing vehicle. Then again, magnets are like that. Of course, we know what draws people in. The unmistakable look, to start, but the power too. Available LED daytime running light technology introduces inviting illumination, and the tapered Audi Singleframe® grille adds a bold sense of daring and an iconic look to the front fascia. But one senses the possibility of more, such as the power distributed by the impressive 2.0-liter turbocharged Audi TFSI® engine and optimized by the available Audi quattro® all-wheel drive. The irony isn't lost on us that, as we sharpened the design lines, as we made the body more streamlined, and as we pushed the envelope of style as far as we could while further embracing the spirit of our Audi Sport® heritage—in short, as we stood farther out on the edge—we've seen more people gravitating toward the uncompromising A5.





A driver-centric school of thought.

The finest materials pepper the interior of every Audi A5. There may be more cost-effective ways to design a vehicle's interior, but ours are intended to stimulate more than just your sight. You'll see, feel and smell the distinctive elements inside the A5. Whether it's the finely stitched leather-wrapped multifunction sport steering wheel in your hands, or the scent of our finely crafted leathers that greets you when you climb into the cockpit, you'll find exactly what you've come to expect from Audi: Sleek, fluid and substantively composed interiors that solidify the connection between you and your vehicle.

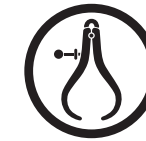

Craftsmanship

We've ensured that every stitch represents the detail that we put into every aspect of an Audi.



Panoramic sunroof

Another enhancement to your drive is the standard panoramic sunroof with tilt functionality of the A5 Coupe. An unimpeded view of the sky gives the feeling of infinite head room. If you don't want to fully engage with the environment, the retractable shade feature is there too. So let the sun drench the interior of your A5 as you enjoy a carefree driving experience.



Split folding rear seatbacks

With 12.2 cubic feet of cargo space in the A5 Coupe and 10.2 cubic feet of cargo space in the A5 Cabriolet with the seatbacks in the up position, the A5 is a capable carrier. The A5 Cabriolet has split folding 50/50 rear seatbacks, and the Coupe features a pass-through in the split folding 60/40 rear seatbacks. You can enjoy all the benefits of a sports car and still have room for your oversized toys.



Compromise and cost-savings need not apply.

Thanks to our multifunction sport steering wheel with available shift paddles, every control you need is right at your fingertips, intuitively placed to ensure ease of operation while you navigate any commute. Our driver-centric cockpit is more than just a design imperative, it is our way to help ensure that you're navigating the vehicle's technology with the same precision that our vehicles perform on the road for you.



Top-up feature.

The top of the A5 Cabriolet invites you to take advantage of clear skies for as long as the sun is out. If clouds do come, it takes approximately 17 seconds for the driver to fully deploy the roof (even at speeds up to 31 mph). When the top is up, it also provides a great acoustic environment designed with both sound-deadening and heat-resistant properties.



The outside is in.

It's style that includes stars, but has nothing to do with Hollywood. It's outside, but not obsessed with waterproof hiking boots. It's the world seen and felt with the top down in your Audi A5 Cabriolet. Day or night, with wind gliding past you, discover a thrilling connection to your environment—while still being plugged into signature automobile technology. You can even stretch your top-down driving season with an available head-level heating system that helps ensure your comfort even when the temperature doesn't match your mood. The A5 Cabriolet takes design, precision and a retractable roof to turn the outside into something that's very much in.





It's OK to be daringly risqué.

There's a certain audacity to going topless, but you're already getting stares. We've got you covered, even with the top down. The available perforated Milano leather seating surfaces with ventilated and heated comfort front seats help ensure a tranquil commute no matter what the weather brings. From heat-reflecting pigments in the leather to an aerodynamic windblocker that helps the air flow by when you open up the drive, we've thought of everything to help ensure your comfort. Don't worry about being bashful. We're not. You can easily bring the top back up and retain a little privacy if you need it, but we don't think you will.



Ventilated and heated front seats

Some added comforts for the top-down drive along the coast are the available heated and ventilated comfort front seats. You can get a little extra touch of warmth from the available head-level heating system vents that blow warm air directly onto your neck and shoulders.

Thermocool feature

The leather surfaces of our Audi A5 Cabriolet are designed with Thermocool special reflecting pigments that, even in direct sunlight, reduce surface temperatures up to 86 degrees, compared with untreated leathers. It's just another way we prove our commitment to your comfort. We've given the phrase "sitting pretty" a whole new meaning.

The case for unbreakable bonds.

Conventional wisdom may suggest that an all-wheel drive system is there purely to provide confidence in inclement weather, but the available Audi quattro® all-wheel drive is much more than just a foul-weather friend. It's performance engineering that takes on a dry, twisty mountain road as beautifully as it tracks through powder.¹ In other words, quattro® helps enhance performance by appropriately transferring power to the necessary wheels when accelerating and turning, so you have confidence-inspiring performance for almost any road condition. Inclement weather aside, the really gripping story about quattro® is how it performs overall, forging a bond between you and the road that really connects.¹



All-around confidence

Just like life, the road can throw you a curve. So throw one right back with the superior grip and control of quattro®. It helps provide the performance and confidence you would expect from Audi, no matter if you're commuting in the city or crisscrossing the country. This is advanced engineering you can live with.



¹ When driving during cold, rainy, snowy or icy weather conditions, ensure that your vehicle is equipped with appropriate all-season or winter tires. Even with appropriate tires, you must always drive in a manner appropriate for the weather, visibility and road conditions. ² Obey all speed and traffic laws.

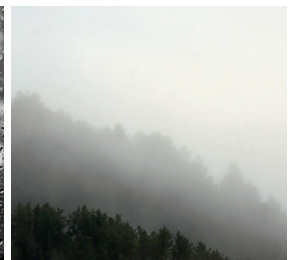
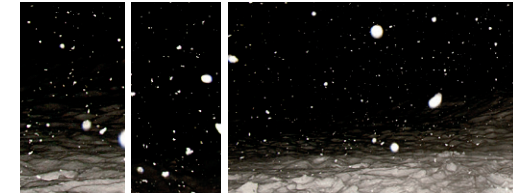

All-weather capability

There is a reason quattro® is considered such a friend in foul weather. Under normal driving conditions, the center differential splits torque at a ratio of 40:60 front to rear, but as conditions change and become more challenging, the ratio is optimized to help maximize grip. And with the ability to transfer the majority of available torque mechanically to the wheels with the most grip, the operation is exceptionally smooth, even under extreme conditions.¹



All-out performance

You don't win races by playing nice? That's why quattro® features one of the most fierce performance features around—torque vectoring. By taking into account your steering input and desired level of acceleration, it can independently brake the inside wheels through a corner and transfer torque to the outside wheels, helping to promote neutral handling.

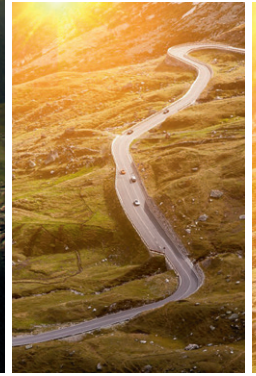

▼ WIND 54 mph

We don't anticipate your response so much as provide it.

At Audi, we believe you should be the ultimate master of your road-going domain. That's why we created the available Audi drive select system. It gives you the ability to adjust the vehicle's steering, throttle response and transmission shift characteristics with the utmost of ease. And with four modes to choose from, no matter what kind of road comes into question, Audi drive select will let you answer.

1

Comfort mode

Perfect for less-than-perfect roads, this setting adds optimized steering and a closer shift pattern to help provide a more relaxed drive.

2

Dynamic mode

Tighter steering and a more responsive throttle give this setting an aggressive feel and focused performance.

3

Auto mode

The best of both worlds, dialed to automatically adjust settings for a seamless combination of comfort and responsiveness based on your driving style and road conditions.

4

Individual mode

Take the turn your way—this mode allows you to adjust the steering, throttle and transmission upshifts to your style.



Transmission

From very responsive, quick gear changes to more gradual acceleration, the transmission is at the heart of Audi drive select.



Throttle-mapping

Depending on the mode of Audi drive select you choose, the throttle can be precisely responsive or a little less so.



Steering

When you turn the steering wheel, you expect the vehicle to react accordingly. Audi drive select helps give you more input on how that will feel.

Under pressure over efficiency.

There is an old school of thought in the automotive world that bigger is better. More horsepower, greater displacement—these were once the hallmark of the industry. Audi, on the other hand, progressed past this antiquated notion of engine design and adopted a system that refines the driving experience. By utilizing lightweight turbocharged engines, we solved two problems at the same time: greater efficiency and more power than was produced by previous engines.¹ And since lighter vehicles breed better performance, the result is an exhilarating driving experience at every turn.

2.0 TFSI® four-cylinder

This 2.0-liter turbocharged DOHC engine produces 220 horsepower and 258 lb-ft of torque, and combines the valvelift system, Audi FSI® direct injection and turbocharging for great power and overall efficiency.¹

air out to intercooler
↑ ↑ ↑ ↑ ↑ ↑ ↑ ↑

220 horsepower
258 lb-ft of torque
Maximum boost pressure: up to 17.4 psi

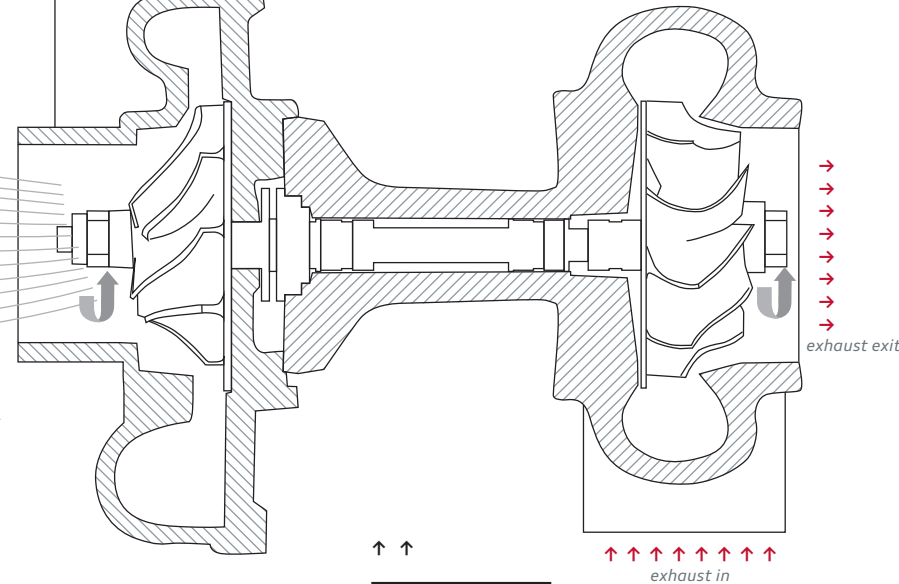

↑ ↑

Exhaust gas intake

Exhaust from the engine spins the turbine that is connected by a shaft to a compressor that pressurizes air. The compressor forces this pressurized air into the cylinders at boosted pressures up to 17.4 psi, thus producing more power from a smaller displacement engine.



Performance

The adage “good things come in small packages” has never been more true.

Induction-technology turbocharger

Compressing the airflow to the engine allows more air into the cylinder and, ultimately, more power from each combustion cycle, significantly improving the engine’s power-to-displacement ratio.

Eight-speed Tiptronic® automatic transmission

As the perfect compromise between a dedicated manual and an automatic gearbox, the eight-speed Tiptronic® automatic transmission available in the Audi A5 offers eight optimized, carefully chosen gear ratios. Selected automatically or via its console-mounted shifter or steering wheel with available shift paddles, precise shifts are delivered without sacrificing the smooth action of the Tiptronic® automatic. A high final drive ratio allows optimization of lower gears, yet the transmission’s upper range emphasizes fuel economy—particularly at highway speeds.¹

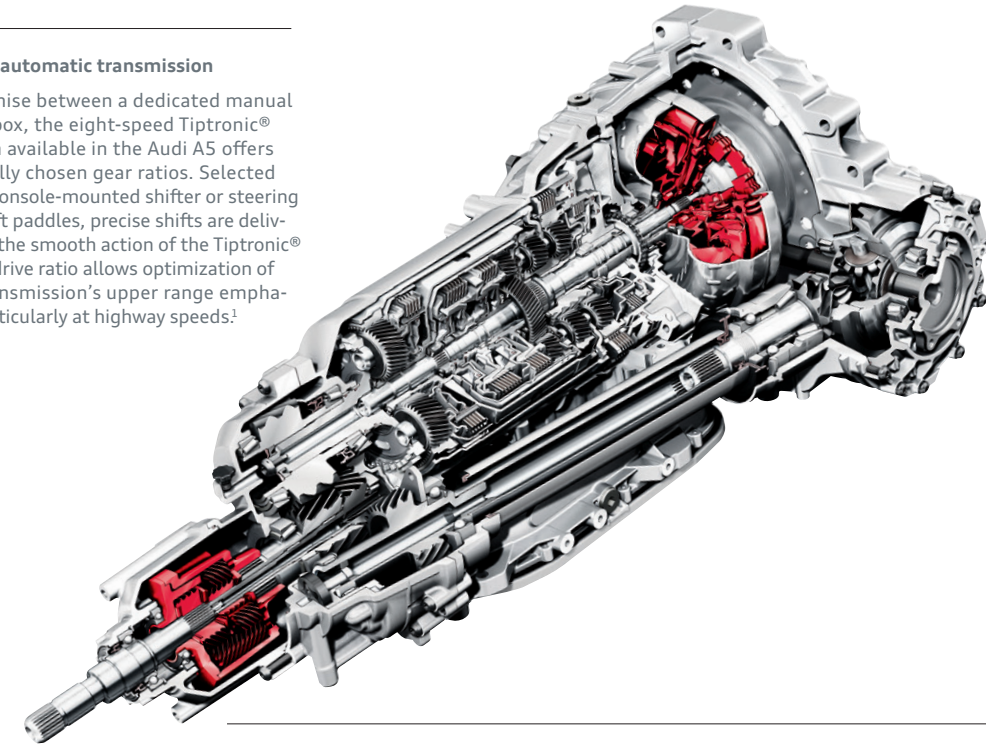

gear	ratio
1ST	4.714:1
2ND	3.143:1
3RD	2.106:1
4TH	1.667:1
5TH	1.285:1
6TH	1.000:1
7TH	0.839:1
8TH	0.667:1

Six-speed manual transmission

For drivers who crave engaging and dynamic response, the Audi A5 Coupe presents an available six-speed manual gearbox that delivers power with vintage Audi finesse. Its short throw and precise ratios add a contemporary element for confident performance on the road.

Audi multitronic® transmission

As a continuously variable transmission, the A5 Cabriolet offers an available Audi multitronic that combines the efficiency of a manual gearbox with the convenience of an automatic transmission.¹ And thanks to its variable ratios and adaptive map control, the Audi multitronic always utilizes the optimal rev range of the engine.

Driving to the tune you choose.

The Audi A5 offers three transmission choices that precisely transmit the power produced by the 2.0-liter TFSI engine. With wide gear ratios for smooth shifting and improved efficiency, it doesn’t matter which transmission you choose. Available steering wheel-mounted shift paddles for automatic transmissions let you shift up or down with minimal effort, while the six-speed manual transmission gives you the control that performance drivers crave. A shift has been made, and the choice is yours: choose what propels your A5.

¹ EPA estimates not available at time of printing. See www.fueleconomy.gov for updated information. Your mileage will vary.

We shed light on your blind spots.

With a suite of available driver assist options, we strive to constantly up the ante on driver convenience. Available Audi side assist helps inform you of other vehicles in the lanes next to you, while available Audi adaptive cruise control helps monitor the distance between you and the vehicle ahead, and adjusts your speed appropriately to keep you moving smoothly. There are also the simple things, like parking system plus, which adds a rear view camera and rear acoustic parking sensors to help ease you into that spot. It's another testament to the effort that Audi puts into helping ensure that you're not the only one keeping an eye on the road.



Driver Assist

We're solving problems before you even know you have them.



Audi adaptive cruise control

Everyone has their own comfort zone. The available Audi adaptive cruise control helps maintain a driver-selected distance from the vehicle in front by using a special long-range radar sensor. The system constantly measures the space between your vehicle and the vehicle ahead and helps maintain it by automatically adjusting your speed. Once the road ahead is clear, the vehicle effortlessly resumes the previously preset speed, helping to make your drive that much more relaxing.

Audi side assist

The available Audi side assist uses radar sensors and two different optical warnings to help keep the driver informed about what is approaching from hard-to-see angles behind and to the side of the vehicle.

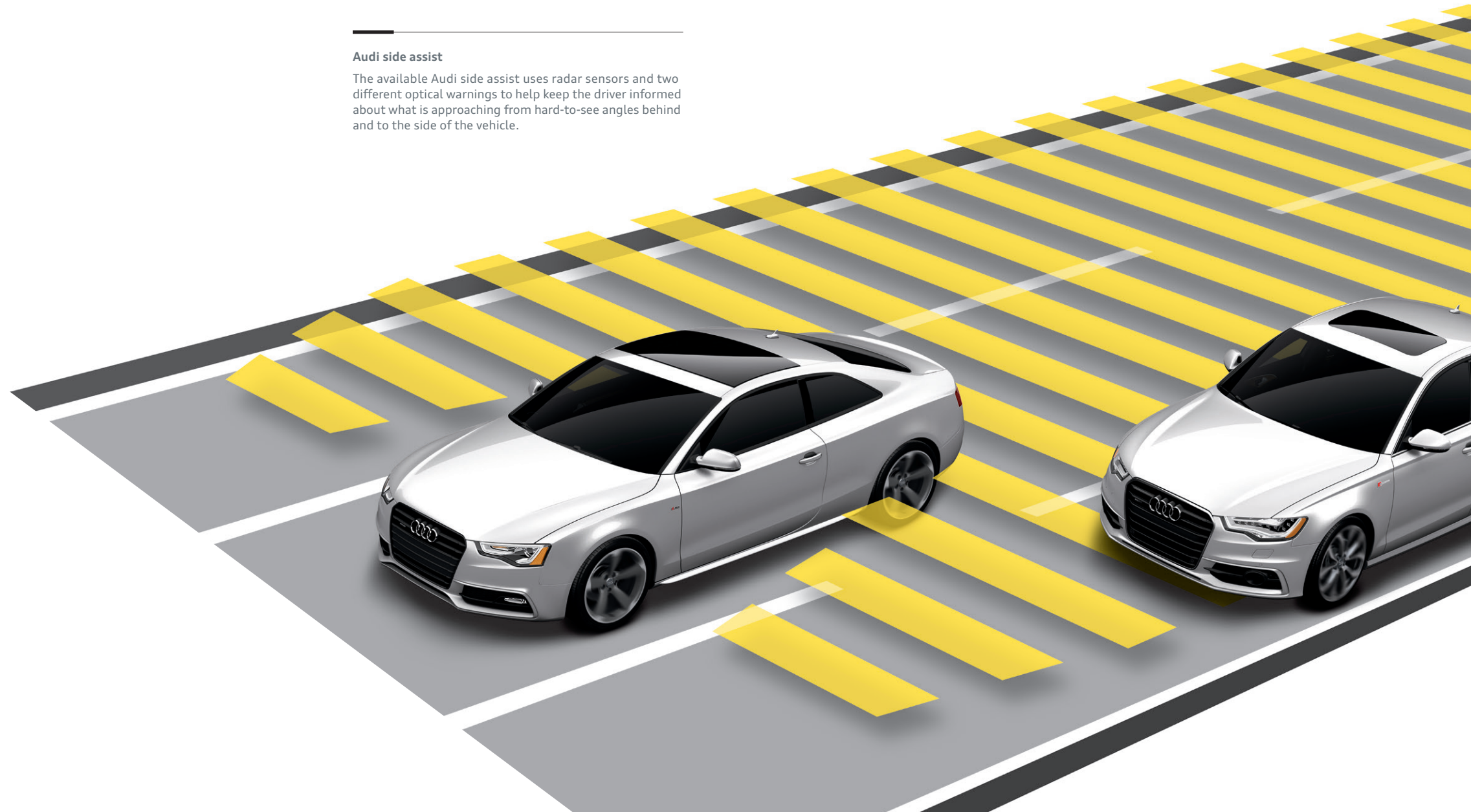

We don't see safety as an option, or a luxury.

We decided that, regardless of size, strong should be a more flexible concept. High-strength steel helps add a measure of security while enhancing overall handling and performance. Sophisticated airbag technology is designed to deploy airbags based on seat position,¹ while specially constructed crumple zones give way upon impact to help mitigate potential injury in a collision. All of this, combined with the rigidity of laser seam-welded joints that enhance the strength of every Audi we make, helps diminish the impact of an unavoidable event.



Safety

Working to spread a “bend, don't break” philosophy.

Pop-up roll bars

In the unlikely event that your A5 Cabriolet rolls over, sensors deploy two roll bars from hidden compartments in the rear, and reinforced A-pillars up front and safety belt pretensioners also help protect passengers. It's another way we keep innovative design as high a priority as your safety.

Airbags

Sensors mounted in the front seats monitor your seating position to help ensure that the adaptive front airbags will deploy in the event of a collision.¹ Driver and passenger front seat-mounted thorax side airbags help keep your upper body protected, while knee-level airbags help keep tabs down below. The A5 Coupe even has two rows of Sideguard® head curtain airbags for an added level of protection.¹

¹ Airbags are supplemental restraints only and will not deploy under all crash circumstances. Always use safety belts and seat children only in the rear, using restraint systems appropriate for their size and age.

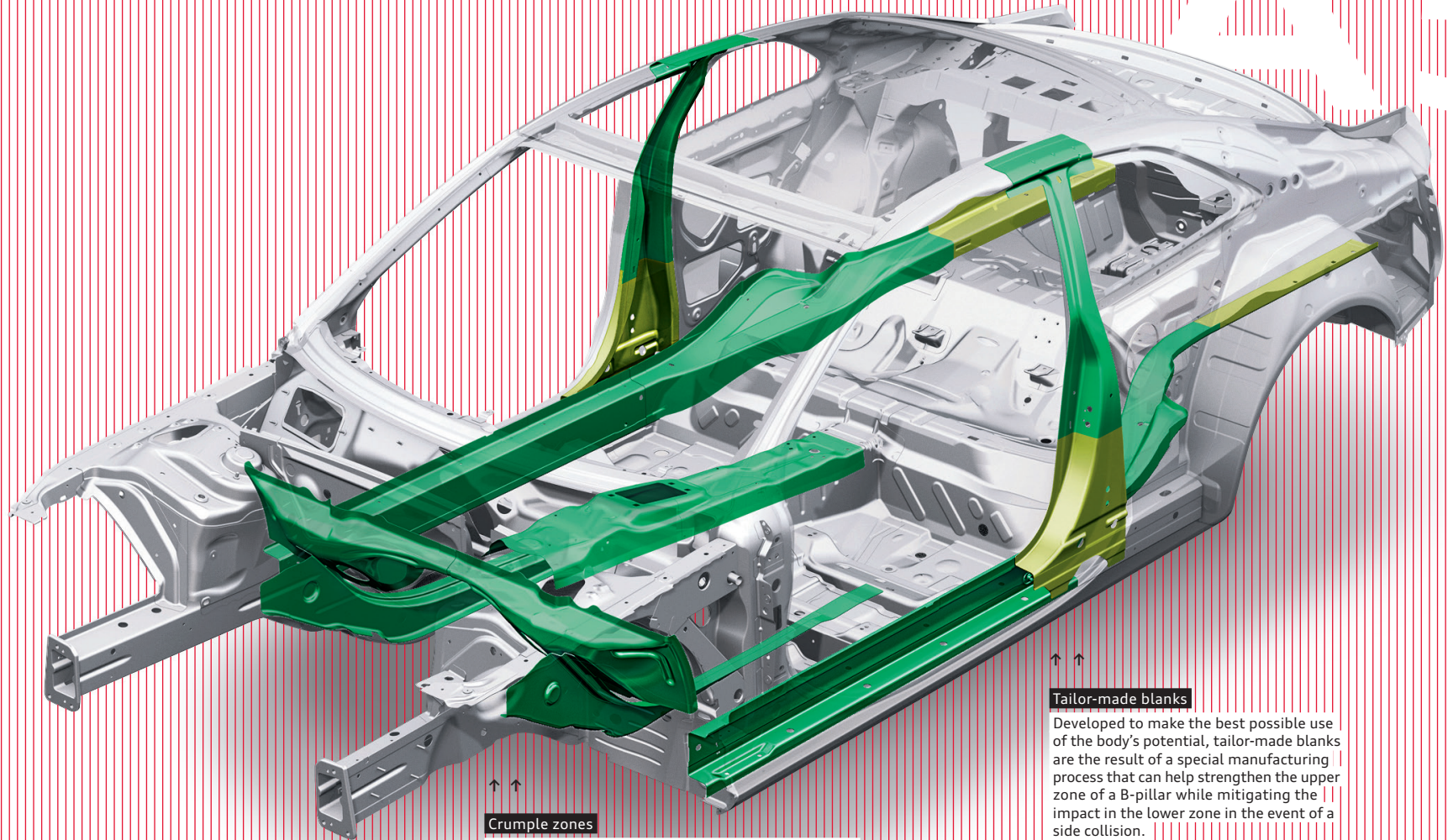

Crumple zones

Knautschzone may be an ugly word, but it's a beautiful technology. German for “crumple zone,” this ingenious safety feature helps dissipate the energy from a collision by spreading the impact forces around the passenger cell and away from its occupants. In doing so, it also slows the vehicle's deceleration rate, which helps to further lessen the force of impact.

Tailor-made blanks

Developed to make the best possible use of the body's potential, tailor-made blanks are the result of a special manufacturing process that can help strengthen the upper zone of a B-pillar while mitigating the impact in the lower zone in the event of a side collision.

Car consciousness.

We believe intelligence is key to a higher form of luxury. You can see this philosophy fully represented in the available Audi MMI® system. Simply put, it's an intuitive system that intimately connects you to almost every facet of the vehicle. It's the nerve center of your vehicle, allowing you to control virtually every interior function of your Audi with a simplified source control button system. From the Audi MMI Navigation plus, to the sound system, to media, MMI helps you access information with a few easy clicks. And even without it, you can pair your compatible phone with the vehicle for added convenience. With this kind of brainpower onboard, you can leave the little stuff to us, and just concentrate on how good it feels to drive.



MMI System

We've brought the backseat driver front and center.

SiriusXM® Satellite Radio

Go ahead. Crisscross the country. We assure you, you'll never run out of entertainment options, with over 130 channels of music, talk, sports and news.¹

Audi media

The media function opens up a world of options when equipped with the Audi MMI Navigation plus, allowing you to control the Audi music interface, Secure Digital (SD) card slots, hard disk drive (HDD) audio jukebox or DVD, and BLUETOOTH® streaming audio.^{1,2,3}

Audi MMI Navigation plus

Count on the available advanced navigation system to home in on your destination with stunning precision while putting a little more depth in your journey with help from Google Earth™.¹

BLUETOOTH® wireless technology

Unlock your mobile phone's potential through the MMI system. Simply pair them up and start enjoying near complete control at the touch of a button.³

¹ See Infotainment/Technology section of the Featured Content page for important information regarding Audi MMI® Navigation plus and required SiriusXM® subscriptions. ² Always pay careful attention to the road, and do not drive while distracted. The features and technologies discussed above are optional, may require an additional subscription with separate terms and conditions, and should be used only when it is safe and appropriate. The Wi-Fi® hotspot feature is intended for passenger use only. ³ Requires compatible phone.

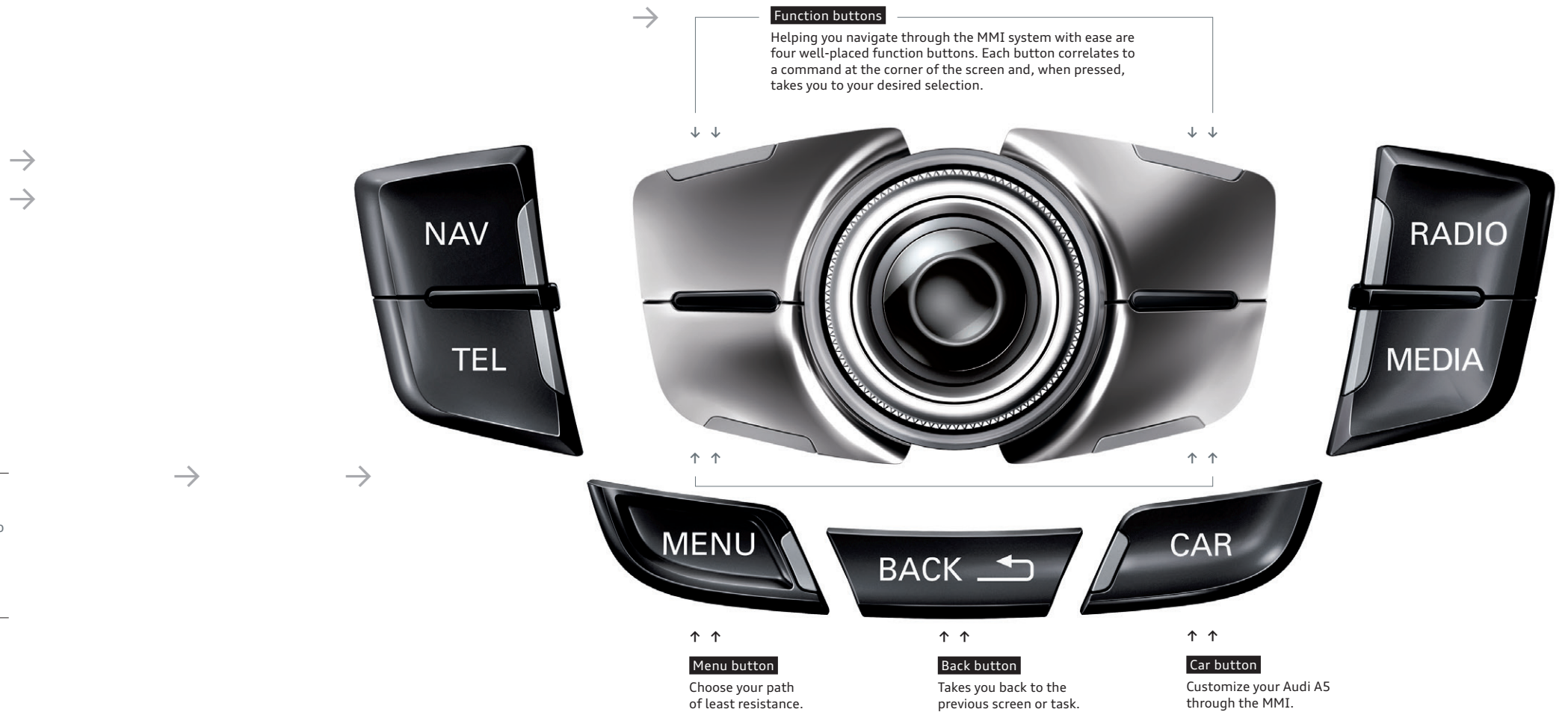

If nothing else, you know your car is listening to you.

Don't reach—relax. While touchscreens are seemingly everywhere, they don't need to be in your vehicle. With available Audi connect®, you may never have to reach out again.¹ Thanks to Google Voice™ Local Search, Audi connect allows you to search Google™ by simple voice commands. The crisp display is nestled farther up, closer to the windshield, so your eyes don't have to focus and refocus between the screen and the road ahead of you. For those times when you are feeling tactile, we've placed toggle buttons near the gear shifter, where your hand naturally rests while you drive. So while other automobile manufacturers still want you to reach out, we've found a few ways for you to make information a lot more accessible while your hands are on the wheel.

POI

Point-of-interest

The point-of-interest search with voice control means that the digital world is with you on every journey.

myAudi

myAudi features

Plan travel from your personal computer. Send your desired destinations to your vehicle ahead of time and access your route from your vehicle later.

NEWS

News feeds

Stay on top of the news by having headlines and stories delivered right to your Audi MMI® display.



Mobile Wi-Fi® hotspot

Provides high-speed connectivity for up to eight passenger devices through an onboard wireless hub.



SiriusXM® Traffic

Get traffic information overlaid onto 3D satellite imagery to visualize a true aerial view of your route, and let the Audi MMI Navigation plus system reconfigure your route to avoid traffic.²



Google Earth™ with 3D satellite imagery

With Google Earth™ integration, you'll enjoy 3D satellite imagery, including Google Maps Street View, displayed right on the Audi MMI display.



Weather information

Current local conditions and forecasts for your destination can help you prepare for your trip.



Google Voice™ Local Search

Simply tell your Audi what you are in the mood for, then let the cloud-processing power of Google™ speech recognition interpret your request and bring up a list of destinations in the area of your choice.



Google Maps Street View

With Google Maps Street View, your vehicle can show you a driver's-eye view of your destination right before you arrive so it's easy to recognize.



Parking information

Search for parking in your area of interest, check space availability and set your selection as a destination to navigate directly to the garage entrance.



City events

Get information about current events, exciting locations and places of interest at your travel destination, current location or other chosen location instantly.



Travel info

Discover local landmarks in your area of interest, set them as your destinations, and let your vehicle lead the way as you explore the world around you.

¹ Always pay careful attention to the road, and do not drive while distracted. The features and technologies discussed above are optional, may require an additional subscription with separate terms and conditions, and should be used only when it is safe and appropriate. The Wi-Fi® hotspot feature is intended for passenger use only. ² See Infotainment/Technology section of the Featured Content page for important information regarding required SiriusXM® subscriptions.



Sound

Audi is Latin for “listen,” so you know we take sound very seriously.

When even a German lullaby is an ode to sound engineering.

It would be an interesting challenge, a note-perfect Brahms’ Lullaby delivered through the tuned speakers of an Audi concert radio system versus the exhilaration of the passing lane. Either way, performance wins. But it goes way beyond the gentle tones of a German composer. Audi sound engineers don’t simply make the cabin acoustics sound perfect for your music, they make the drivetrain sing. Or, if not sing, then put it in harmony with every other element of the driving experience. From the sound of a shutting door, to the click of a turning knob, to the full integration of an available Bang & Olufsen® Sound System, there’s an orchestra of engineering that fills your cabin with faithfully rendered, thrilling sound. Whatever it is you are looking for, Audi sculpts sounds in a way that matches your mood, even when you need soothing while in traffic.

Bang & Olufsen® Sound System

Dedicated to the idea of “honest music reproduction,” Bang & Olufsen® is a sound engineer’s dream. Through an available 505-watt system perfectly integrated within your Audi, Bang & Olufsen® is set on transcending the limits of audio technology. By automatically adjusting volume and timbre balance to changing ambient noise levels, and offering richly tuned acoustics, you’ll hear the truth about how good life can sound in your Audi.



A5 Coupe ↓

14 speakers

A5 Cabriolet ↓

12 speakers

Optimized sound flows through strategically placed speakers around the cabin. Hear it, and you’ll instantly become engrossed in the tiniest detail and warmth of the sound.

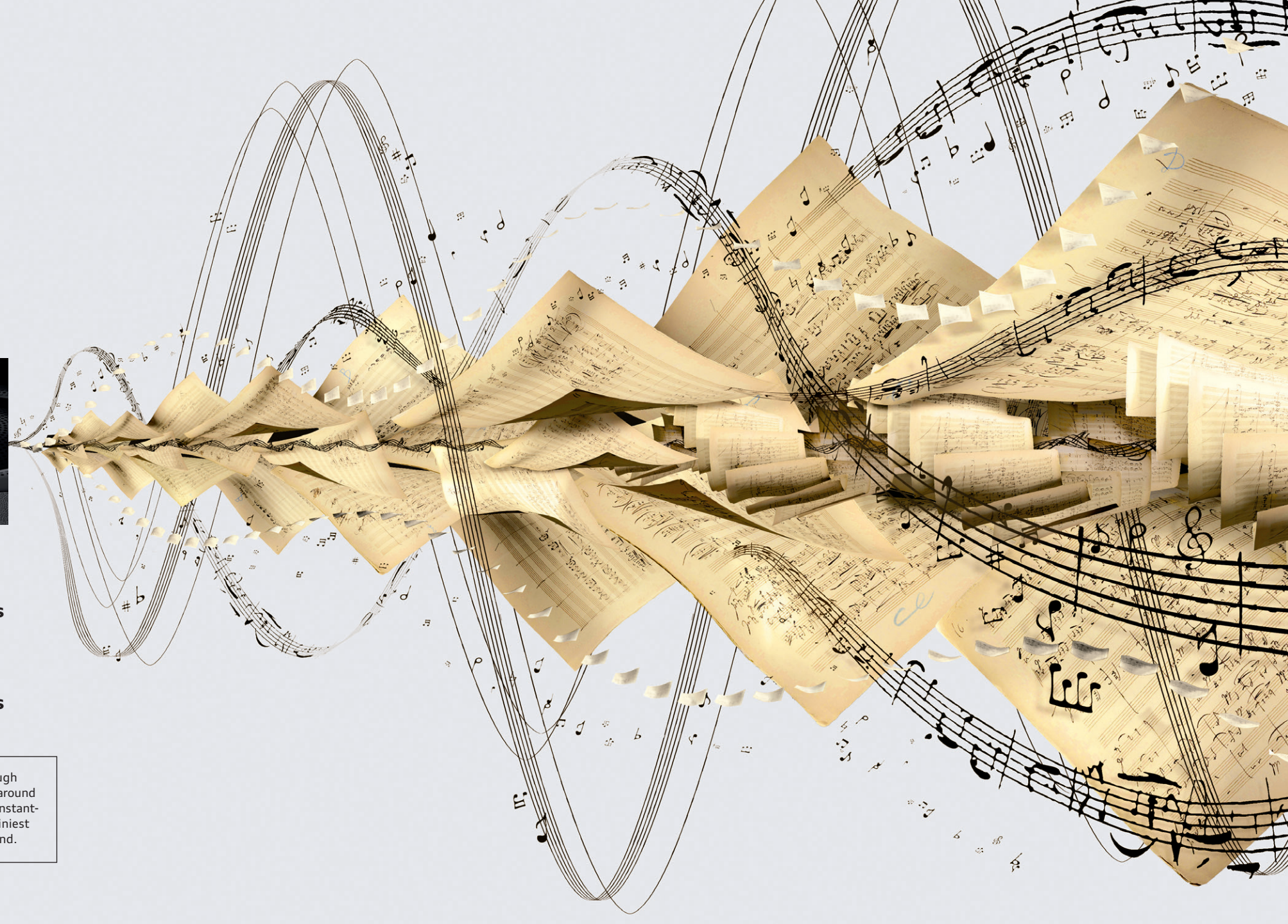



S5

ENGINE // 3.0-liter supercharged TFSI® V6 engine developing 333 hp and 325 lb-ft of torque

DRIVETRAIN // Audi quattro® all-wheel drive, available sport differential, six-speed manual transmission or an available seven-speed Audi S tronic® dual-clutch transmission

CHASSIS // S5 tuned sport suspension, Audi drive select and available dynamic steering

BRAKES // 13.6" ventilated front disc brakes with S5 logo, 13.0" ventilated rear disc brakes

PERFORMANCE // Top track speed of 155 mph¹; acceleration from 0 to 60 mph in 4.9 seconds (Coupe) and 5.3 seconds (Cabriolet)



Far beyond accoutrements.

Make after-market an afterthought.

While the Audi A5 may be everything the devotee of the authentic coupe requires, sometimes even a purist yearns for a little bit more. A supercharged 3.0-liter TFSI® V6 engine sits comfortably under the hood of the Audi S5, producing 333 horsepower and an exhilarating 325 lb-ft of torque, to propel the S5 Coupe to 60 mph in just 4.9 seconds. Experience the heart and soul of Audi performance cars through the sport-tuned suspension that is ready for the street or the track. While most automotive manufacturers want you to upgrade your engine with after-market tricks, we developed a line of vehicles that require only your enthusiasm.

Audi Sport

The story doesn't stop here. There's more on the full range of S, RS, and R8 Audi performance models in the **2014 Audi Sport brochure**. See your dealer or go to audiusa.com for details.

¹ Top track speed is electronically limited in the U.S. Obey all speed and traffic laws.

Exterior Colors

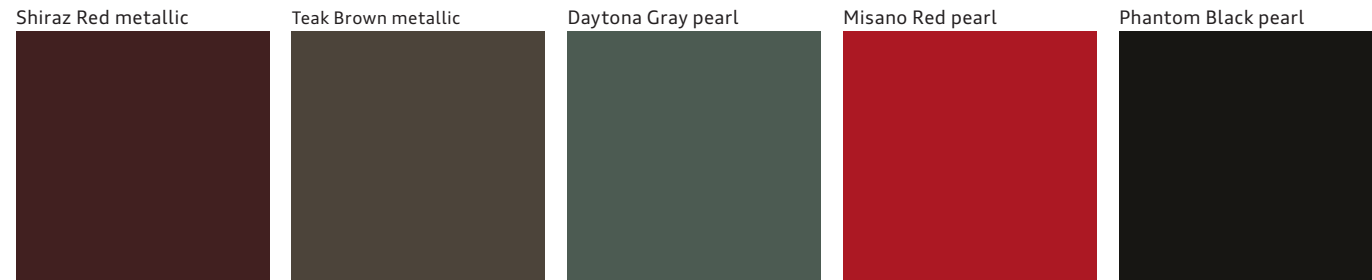
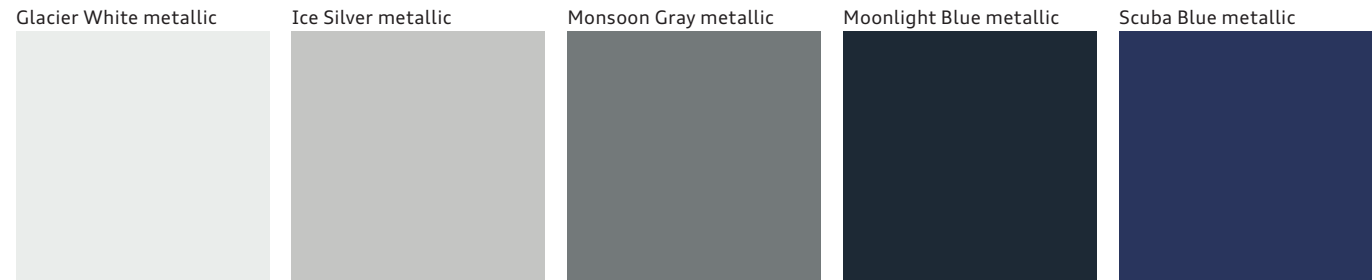

A5 Cabriolet only

Audi S line® Competition package (Coupe)

Audi S line® Competition package (Coupe)

Black acoustic folding roof



Brown acoustic folding roof



Interior Colors | Seat Selections

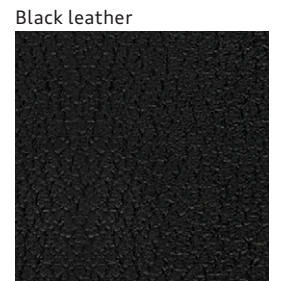

Standard, Sport

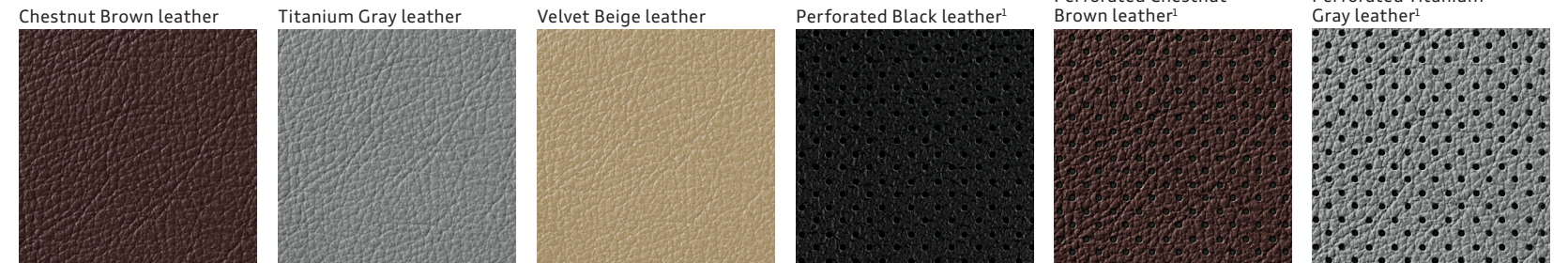

Standard, Sport

Standard, Sport

Standard

Comfort

Comfort

Comfort



Comfort



Audi exclusive line package, Sport



Audi exclusive line package, Sport (Coupe)



Audi exclusive line package, Sport



Audi exclusive line package, Sport (Cabriolet)



Audi S line® Interior package, Sport
Audi S line® Competition package, Sport (Coupe)

¹ Available in A5 Cabriolet with Comfort package only.

Decorative Inlays

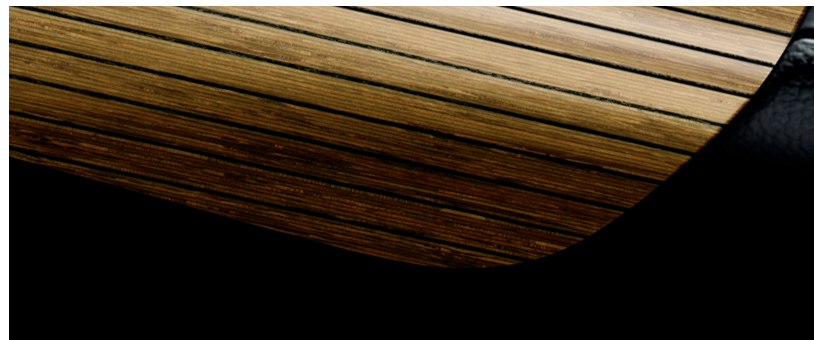

Aluminum Trigon inlay¹

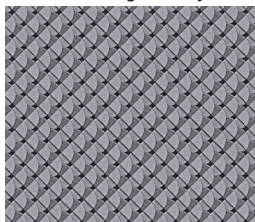

Dark Brown Walnut Wood inlay¹

Fine Grain Ash Natural Brown Wood inlay¹

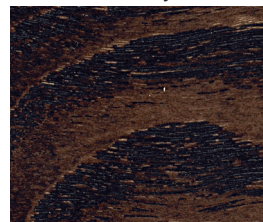

Layered Oak Wood inlay¹



Piano Black inlay¹

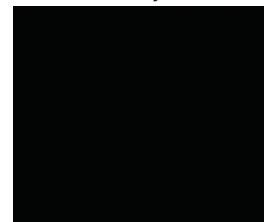

Audi S line® Competition package (Coupe), Audi exclusive line package

Brushed Aluminum inlay¹



Audi S line® Interior package, Audi exclusive line package (optional)

¹ Decorative inlay options will vary based on model and interior color combination. See your dealer for details.

Wheels

18" 5-spoke V design
245/40 all-season tires



A5 Premium, Premium plus and Prestige

18" 5-arm-dynamic design
245/40 all-season tires



A5 Premium, Premium plus and Prestige (optional)

19" 10-spoke design
255/35 summer performance tires²



A5 Premium plus and Prestige (optional)

19" 5-arm-rotor design (Titanium finish)
255/35 summer performance tires²



A5 Coupe Premium plus and Prestige (Black Optic package)
A5 Cabriolet Premium plus and Prestige (optional)

19" 5-segment-spoke design (Titanium finish)
255/35 summer performance tires²



A5 Coupe Premium plus and Prestige (Audi S line® Competition package)

² Tires are supplied and warranted by their manufacturer. High-performance tires are designed for optimum performance and handling in warm climates. They are not suitable for cold, snowy or icy weather conditions. If you drive under those circumstances, you should equip your vehicle with all-season or winter tires, which offer better traction under those conditions. We suggest you use the recommended winter or all-season tires specified for your car or its equivalent. These high-performance tires also have a lower aspect ratio that aids performance and handling; however, in order to avoid tire, rim or vehicle damage, it is important that the inflation pressure is regularly checked and maintained at optimum levels. Please also remember in making your selection that, while these tires deliver responsive handling, they may ride less comfortably and make more noise than other choices. Finally, these tires may wear more quickly than other choices.

Technical Specifications

Engineering | Performance

	A5 2.0T Coupe	A5 2.0T Cabriolet
Engine type	Four-cylinder	Four-cylinder
Engine block/Cylinder head	Cast-iron/Aluminum-alloy	Cast-iron/Aluminum-alloy
Displacement (cc)/Bore and stroke (mm)	1,984/82.5 x 92.8	1,984/82.5 x 92.8
Horsepower (@ rpm)	220 @ 4,450–6,000	220 @ 4,450–6,000
Torque (lb-ft @ rpm)	258 @ 1,500–4,300	258 @ 1,500–4,300
Compression ratio	9.6:1	9.6:1
Valvetrain	16-valve DOHC with valvelift system	16-valve DOHC with valvelift system
Induction/Fuel injection	Turbocharged/TFSI®	Turbocharged/TFSI®
Acceleration with manual/Tiptronic® transmission (0–60 mph)	6.3/6.1 seconds	—
Acceleration with Audi multitronic®/Tiptronic® transmission (0–60 mph)	—	7.1/6.6 seconds
Top track speed ¹	130 mph	130 mph

Transmission | Drivetrain

Audi multitronic® continuously variable transmission with front-wheel drive (Gear ratios: 1st: 2.436, 2nd: 1.626, 3rd: 1.231, 4th: 0.976, 5th: 0.783, 6th: 0.628, 7th: 0.499, 8th: 0.382, Reverse: 2.919, Final drive: 4.612)	—	Available
Six-speed manual transmission with Audi quattro® all-wheel drive (Gear ratios: 1st: 3.778, 2nd: 2.050, 3rd: 1.321, 4th: 0.970, 5th: 0.757, 6th: 0.625, Reverse: 3.333, Final drive: 3.693)	Available	—
Eight-speed Tiptronic® automatic transmission with Audi quattro® all-wheel drive (Gear ratios: 1st: 4.714, 2nd: 3.143, 3rd: 2.106, 4th: 1.667, 5th: 1.285, 6th: 1.000, 7th: 0.839, 8th: 0.667, Reverse: 3.317, Final drive: 2.848)	Available	Available

Body | Suspension | Chassis

Fully galvanized steel unibody with aluminum front fenders and multistep anti-corrosion protection	■	■
Five-link front suspension	■	■
Trapezoidal-link rear suspension	■	■
Sport suspension calibration (Premium plus and Prestige)	Available	Available
Ventilated front disc/Solid rear disc brakes (in)	12.6/11.8	12.6/11.8
Electromechanical power steering system	■	■
Dynamic steering (Prestige)	Available	Available
Steering ratio	15.9:1	15.9:1
Turning diameter, curb-to-curb (ft)	37.4	37.4

■ Standard — Not applicable NA Information not available at time of printing

Exterior measurements

	A5 2.0T Coupe	A5 2.0T Cabriolet
Wheelbase (in)	108.3	108.3
Length (in)	182.1	182.1
Height (in)	54.0	54.4
Overall width with mirrors (in)	79.5	79.5
Overall width without mirrors (in)	73.0	73.0
Track front/rear (in)	62.6/62.1	62.6/62.1
Curb weight with Audi multitronic® transmission (lb)	—	3,880
Curb weight with manual transmission (lb)	3,583	—
Curb weight with Tiptronic® transmission (lb)	3,682	4,045
Drag coefficient (Cw)	.32	.34

Interior measurements

Head room (in, front/rear)	37.5/36.0	40.0/36.3
Head room with sunshade (in, front/rear)	37.6/36.0	—
Leg room (in, front/rear)	41.3/31.7	41.3/31.9
Shoulder room (in, front/rear)	54.3/52.8	54.3/46.8
Cargo volume (cu ft, rear seatbacks up)	12.2	10.2
Seating capacity	4	4

EPA mileage estimates | Capacities | Emissions

Audi multitronic® transmission (city/highway/combined) ²	—	NA
Manual transmission (city/highway/combined) ²	NA	—
Tiptronic® automatic transmission (city/highway/combined) ²	NA	NA
Engine oil (qt)	4.9	4.9
Fuel (gal)	16.1	16.1
Recommended fuel	Premium	Premium
Emissions rating	ULEV II	ULEV II



Technical specifications and featured content for Audi S5 and RS 5 models can be found in the **2014 Audi Sport brochure**. See your dealer or go to audiusa.com for details.

¹ Top track speed is electronically limited in the U.S. Obey all speed and traffic laws. ² EPA estimates not available at time of printing. See www.fueleconomy.gov for updated information. Your mileage will vary.

Featured Content

Safety Security	Premium	Premium plus	Prestige
Driver and front passenger dual-stage airbags, front thorax side airbags, knee airbags, and Sideguard® head curtain airbags ¹ (Coupe)	■	■	■
Driver and front passenger dual-stage airbags, knee airbags, and front head/thorax side airbags ¹ (Cabriolet)	■	■	■
Front passenger occupant detection for airbags ¹	■	■	■
Pop-up roll bar system (Cabriolet)	■	■	■
Safety belt reminder for driver and front passenger	■	■	■
Lower Anchors and Tethers for Children (LATCH) in rear seats (Lower Anchors only on Cabriolet)	■	■	■
Power central locking system with safety unlock feature if airbags deploy	■	■	■
Electronic Stability Control (ESC) with traction control (ASR)	■	■	■
Anti-lock Brake System (ABS) with Electronic Brake-pressure Distribution (EBD) and brake assist	■	■	■
Tire-pressure monitoring system	■	■	■
Electromechanical parking brake	■	■	■
Anti-theft alarm system with immobilizer	■	■	■

Exterior

Audi Singleframe® grille	■	■	■
Gloss Black Audi Singleframe® grille (Coupe)	—	Available	Available
Halogen headlights with daytime running lights	■	—	—
Xenon plus headlights with LED daytime running light technology	Available	■	—
Adaptive xenon plus headlights with LED daytime running light technology	—	—	■
Automatic headlights	■	■	■
Front fog lights	■	■	■
LED taillight technology and rear fog lights	Available	■	■
Power-adjustable heated exterior side mirrors	■	—	—
Power-adjustable, auto-dimming, heated exterior side mirrors with memory	—	■	■
LED turn indicator light technology integrated into the exterior side mirrors	■	■	■
Aluminum trim around exterior windows (windshield frame on Cabriolet)	■	■	■
Gloss Black trim around exterior windows (Coupe)	—	Available	Available
Dual exhaust outlets	■	■	■
Audi S line® exterior appearance	—	—	■
Audi S line® Competition package exterior appearance (Gloss Black Audi Singleframe® grille, exterior side-mirror housings, side sills and rear diffuser)	—	Available (Coupe)	Available (Coupe)

■ Standard — Not applicable NA Information not available at time of printing

Interior	Premium	Premium plus	Prestige
Three-zone automatic climate control	■	■	■
Three-spoke multifunction sport steering wheel	■	■	■
Three-spoke multifunction flat-bottom sport steering wheel	—	Available (Coupe)	Available
Shift paddles (automatic transmission)	—	Available	Available
Tilt and telescopic manually adjustable steering column	■	■	■
Auto-dimming interior rear view mirror with digital compass	—	■	■
Leather-wrapped shift knob	■	■	■
Audi S line® Competition package exclusive manual shift knob (Coupe)	—	Available	Available
Folding and sliding front center armrest with height adjustment	■	■	■
Decorative interior inlays (see Decorative Inlays page for more detail)	■	■	■
Front and rear footwell LED lighting technology	■	■	■
Ambient LED interior lighting technology	■	■	■
Black cloth headliner (Coupe, with Chestnut Brown leather or Audi S line® packages)	Available	Available	Available
Black cloth headliner (Cabriolet, with Audi S line® Interior package)	—	—	Available
Power windows with one-touch up/down operation and pinch protection	■	■	■
Power rear window sunshade (Coupe)	—	—	Available
Panoramic tilting sunroof (Coupe)	■	■	■
Acoustic folding roof—folds at speeds up to 31 mph (Cabriolet)	■	■	■

Seating

Leather seating surfaces (see Interior Colors page for more detail)	■	■	■
Leather/Alcantara® seating surfaces (see Interior Colors page for more detail)	—	Available (Coupe)	Available
Perforated Milano leather seating surfaces (see Interior Colors page for more detail)	—	Available (Cabriolet)	Available (Cabriolet)
Audi exclusive line bicolor Fine Nappa leather seating surfaces (see Interior Colors page for more detail)	—	Available	Available
Eight-way power front seats and four-way power lumbar adjustment for driver	■	■	■
Twelve-way power front sport seats, including four-way power lumbar adjustment	—	Available	Available
Driver seat memory	—	■	■
Heated front seats	Available	■	■
Ventilated front seats (Cabriolet)	—	Available	Available
Head-level heating system (Cabriolet)	—	Available	Available
Split folding rear seatbacks	■	■	■

¹ Airbags are supplemental restraints only and will not deploy under all crash circumstances. Always use safety belts and seat children only in the rear, using restraint systems appropriate for their size and age.

Featured Content

Infotainment Technology	Premium	Premium plus	Prestige
Audi MMI® Navigation plus with voice control system ¹ (voice control not available on Cabriolet)	—	Available	■
Audi connect® with six-month trial subscription ²	—	Available	■
Driver information system	■	■	—
Color driver information system	—	Available	■
Audi concert radio with ten speakers and single CD player with MP3 playback capability	■	■	—
Bang & Olufsen® Sound System with 14 speakers and 505 watts (12 speakers on Cabriolet)	—	Available	■
HD Radio™ Technology	—	Available	■
SiriusXM® Satellite Radio with 90-day trial subscription ³	■	■	■
SiriusXM® Traffic with four-year subscription ³	—	Available	■
SD card slot with 32GB operating capacity (dual slots if equipped with Audi MMI® Navigation plus)	■	■	■
Audi music interface with iPod® integration	■	■	■
BLUETOOTH® streaming audio ⁴	—	Available	■
BLUETOOTH® wireless technology preparation for mobile phone ⁴	■	■	■
Garage door opener (HomeLink®)	■	■	■
Three 12-volt power outlets	■	■	■
Audi advanced key—keyless start, stop and entry ⁵	—	■	■
Cruise control with coast, resume and accelerate features	■	■	■
Audi adaptive cruise control	—	—	Available
Audi side assist	—	Available ⁶	■
Audi drive select	—	Available	Available
Parking system plus with rear view camera	—	Available	■
Rain/light sensor for automatic windshield wipers and headlights	■	■	■

■ Standard — Not applicable

¹ Audi MMI® Navigation plus depends on signals from the worldwide Global Positioning Satellite network. The vehicle's electrical system and existing wireless and satellite technologies must be available and operating properly for the system to function. The system is designed to provide you with suggested routes in locating addresses, destinations and other points of interest. Changes in street names, construction zones, traffic flow, points of interest and other road system changes are beyond the control of Audi of America, Inc. Complete detailed mapping of lanes, roads, streets, toll roads, highways, etc., is not possible, therefore you may encounter discrepancies between the mapping and your actual location. Please rely on your individual judgment in determining whether or not to follow a suggested Audi MMI® Navigation plus route. For mapping updates please see your Audi dealer or call 1-800-FOR-AUDI for details. ² See the Audi connect® page for important information about Audi connect®. ³ SiriusXM® Satellite Radio and Traffic subscriptions sold separately or as a package after trial expires. SiriusXM® Traffic service available in select markets. Subscriptions are governed by SiriusXM® Customer Agreement (see www.siriusxm.com) and are continuous until you call SiriusXM® to cancel. SiriusXM® U.S. Satellite Service available only to those 18 and older in the 48 contiguous U.S.A., D.C. and Puerto Rico (with coverage limitations). ⁴ Requires compatible phone. ⁵ Some Audi models are equipped with a keyless ignition feature. The details as to how the system works can vary, and Audi owners should consult their owner's literature or an authorized Audi dealer if they have further questions about the operation of this feature. Please note that Audi warns against leaving the vehicle unattended with the engine running, particularly in enclosed spaces. ⁶ Delayed availability.

The new method behind cool.

We've never felt the need to "compete," but we don't shy away from a challenge either. While we've designed vehicles for the racetrack, we know that sometimes you want the racetrack feel without the need for a pit crew to manage your daily commute. This is part of why we developed the available Audi S line® Competition package. Titanium-finished 19" wheels accent the already aggressive appearance delivered by Gloss Black mirror housings, the Audi Singleframe® grille, side sills and rear diffuser. Inside, you'll find Piano Black decorative inlays on the doors and center console. We also provided leather/Alcantara® seating surfaces, so you'll feel strapped in and ready for the green flag or the green light. So take hold of the Audi exclusive shift knob (manual transmission), and get ready to receive the attention of passers-by and fellow commuters alike.



Accessories

Add a new point of view, a dash of distinction and the ultimate in self-expression with Audi Genuine Accessories. Whether you load the cargo carrier with climbing gear or add a set of sporty new wheels, we've got the accessories that will help enhance every facet of your lifestyle. Designed for seamless compatibility with your Audi,

all pieces are backed by your vehicle's 4-year/50,000-mile limited warranty or the accessory's 12-month/12,000-mile limited warranty, whichever extends longer from the accessory purchase date! If you're looking to personalize or protect, Audi offers an intelligent solution.



Compact cargo carrier

A trim, aerodynamic design that offers a generous 16.95-cu-ft capacity. Size: 81" long, 30" wide, 15" high.²

Ski and snowboard rack

Push-button, keyed locks open and close easily. Rubber-cushioned aluminum bars hold securely. Standard attachment (shown) holds two sets of skis or two snowboards. Deluxe attachment holds up to three sets of skis or four snowboards^{2,3}



A5 all-weather floor mats

Deep-ribbed, channeled design helps protect the floor and carpeting from water, mud, sand and snow. Black mats feature the vehicle logo and are available in sets of two for front or rear.



19" 5-arm hollow-spoke wheels

Experience the high-performance beauty of this eye-catching design. The hollow-spoke feature results in a lightweight wheel that allows for more precise handling. Shown in Black, also available in Silver or Anthracite.

19" 15-spoke wheels

An impressive, clean, drop-center, deep-dish design makes this 15-spoke wheel the perfect complement to the A5.



Valve stem caps

Emblazoned with the iconic Audi rings, these handsome caps complement the unique design of the wheels on your Audi.

Rear wing (A5 Coupe only)

This sleek, aerodynamic appointment augments the already stylish A5 rear view.



S5 all-weather floor mats

Deep-ribbed, channeled design helps protect the floor and carpeting from water, mud, sand and snow. Black mats feature the S5 logo and are available in sets of two for front or rear.



Audi S5 Alu-optic trim package

For the Audi S5 Cabriolet and Coupe, the package includes two red or carbon fiber "Supercharged" fender badges, plus Aluminum-optic stone guards that match the side mirrors and mount between the wheel wells.

Other accessories not shown

→ Audi Genuine Alloy Wheels

→ Strike the perfect balance between breathtaking design and awe-inspiring performance with Audi Genuine Alloy Wheels. Audi experts have meticulously designed these wheels especially for each Audi model. They're engineered to the highest standards and endure rigorous testing to help ensure long-term quality. Experience eye-catching style that is yours and yours alone. Nothing enhances the bold, dynamic look of your Audi vehicle faster.

Audi TravelSpace Transport Accessories

You go almost everywhere. Give your Audi the proper invitation to be part of your adventures. Never leave the necessary gear behind. Bring it with Audi TravelSpace Transport Accessories. The list includes bike racks, ski racks, a variety of watersports equipment carriers and various sizes of cargo carriers. Wherever you go, make sure almost everything fits with a variety of intelligent and innovative solutions. Accessories designed for your life—the passionate, active part.

Audi Genuine Electronics Accessories

The illuminating technology that graces each Audi vehicle provides the inspiration for Audi Genuine Electronics Accessories. Similarly, all of these accessories are impressively advanced and inspiring. Our audio options let you enhance your listening pleasure. Other accessory options help promote more convenient travel. All are designed and tested to help ensure compatibility with the vehicle's electrical systems, allowing you to enjoy every aspect of Audi technology with almost all your senses. Demand the best and drive with added confidence.

Audi Guard Comfort and Protection Accessories

Help protect what you love. Audi Guard Comfort and Protection Accessories offer functional, practical items that help keep your Audi in pristine condition. Choose from such useful items as trunk liners that help make clean-up quick and easy, or an easy-to-use storage cover that helps shield the vehicle. Use them all to help reduce wear and tear and keep the vehicle looking like new—inside and out. All are engineered to stringent Audi standards, so you can be assured of their quality and durability.

Audi Guard Car Care Products

Audi vehicles deserve the very best, and this is it: the only car care line specifically designed for Audi. Audi Guard Car Care Products provide gentle cleansing formulas and special tools to help give all interior and exterior surfaces the finest in cleaning and protection. Our shampoos and waxes undergo testing for cleaning performance, change in luster and material compatibility. For the ultimate in shine and sparkle, trust Audi Guard. Pristine, perfect.

¹ See dealer for details. ² All roof-rack system attachments require the base carrier bars. All attachments sold separately. ³ Recreational equipment and sporting equipment not included.