



SPORTING INTENTIONS.

COUPE AND CONVERTIBLE.

Continuing a lineage that began with the BMW 2002, the BMW 2 Series is set to make every drive a thrill. With powerful TwinPower Turbo engines, precise reflexes and typical BMW refinement, the 2 Series proudly continues the 2002's sporting legacy.

BMW 2 SERIES

2



COUPE D'ÉTAT.

Performance is paramount in the BMW 2 Series Coupe. Available with an M-tuned Suspension and M Performance TwinPower Turbo engine, the 2 Series makes every drive a qualifying event for pole position.

BMW 2 SERIES COUPE

[EXTERIOR COLORS](#)

[UPHOLSTERY](#)

[INTERIOR TRIMS](#)

[WHEELS / TIRES](#)

[PACKAGES](#)

[TECHNICAL DATA](#)



A CHANCE TO MHANCE.

The M Sport Package for the BMW 2 Series provides a boost of M adrenaline. The Aerodynamic kit, shadowline exterior trim and 18-inch M light alloy wheels pump up the muscle outside. Inside, the optional 10-way adjustable sport seats, three-spoke M steering wheel and M aluminum footrest get your senses ready for the starting grid.



RACE SPACE.

The refined interior of the BMW 2 Series offers both relaxation and performance. Leather graces the steering wheel and sport seats and is complemented by Fineline Wood, Aluminum Hexagon or high-gloss Black trim. The easy-to-read gauge cluster and control interfaces help keep you focused on the road ahead.

2

SERIES COUPE

EXTERIOR

NON-METALLIC

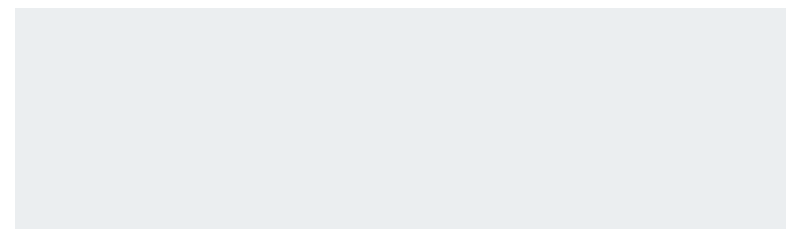

300 Alpine White (Non-metallic)

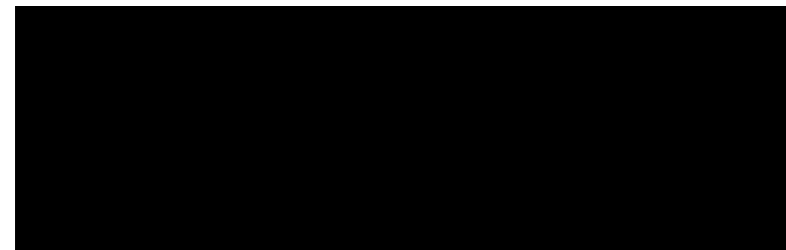

668 Jet Black (Non-metallic)

METALLIC

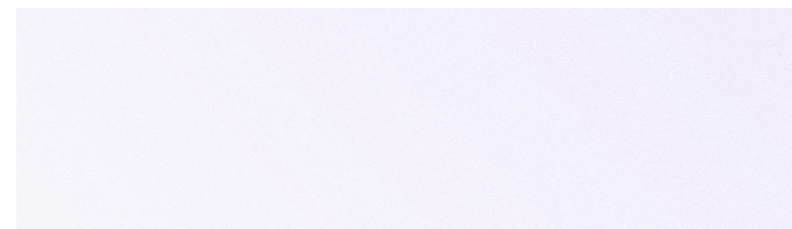

A96 Mineral White Metallic

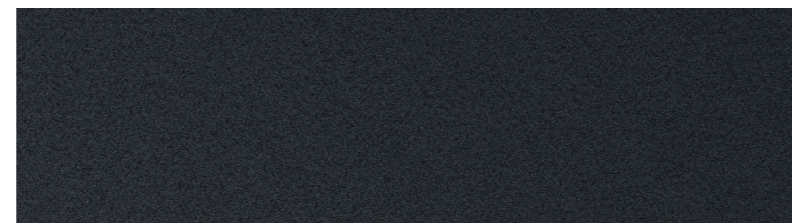

B39 Mineral Gray Metallic



A83 Glacier Silver Metallic

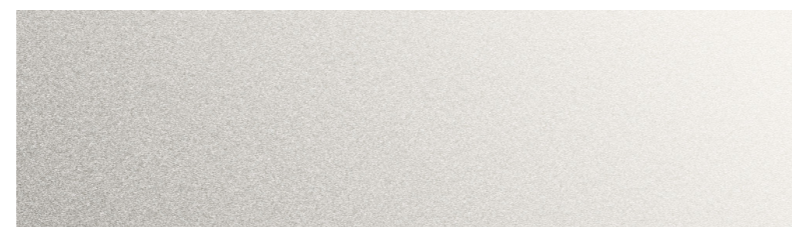

B66 Moonlight Silver Metallic

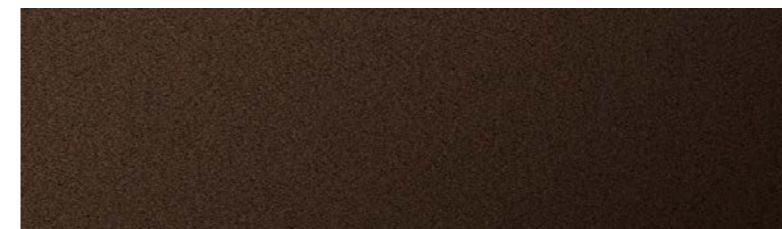

B53 Sparkling Brown Metallic

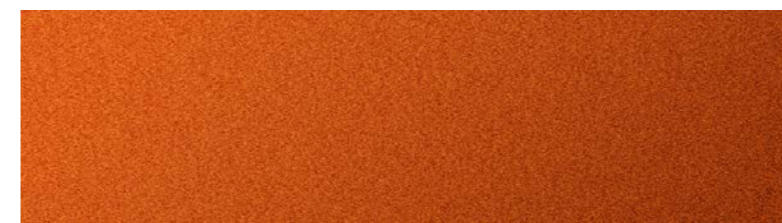

B44 Valencia Orange Metallic



B38 Midnight Blue Metallic



A76 Deep Sea Blue Metallic

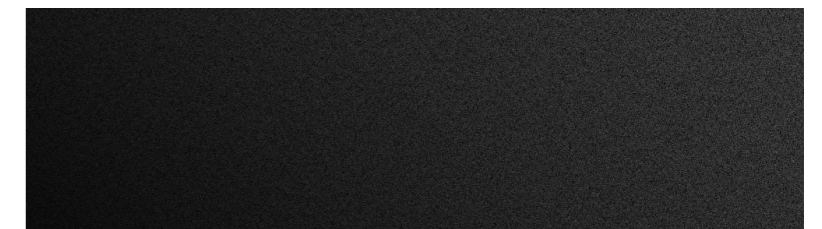

475 Black Sapphire Metallic



A75 Melbourne Red Metallic

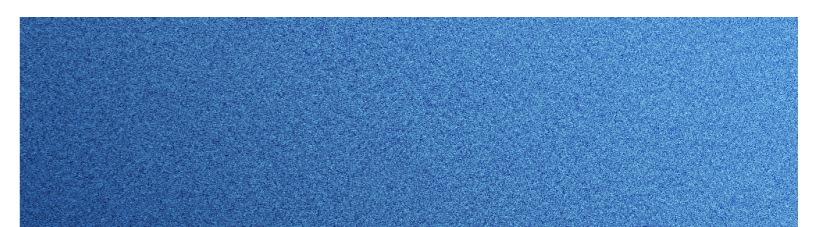

B45 Estoril Blue Metallic

2 SERIES COUPE

UPHOLSTERY

SENSATEC

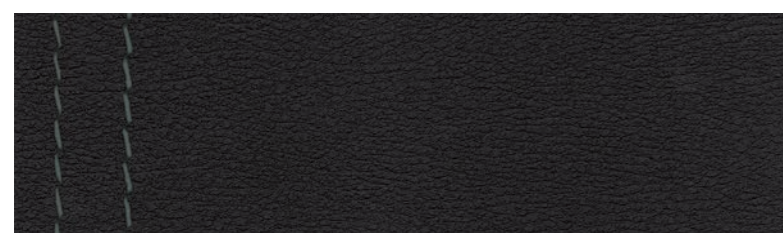

KCSW Black SensaTec



KCCX Oyster / Black SensaTec



KCL3 Black SensaTec / Red highlight

DAKOTA LEATHER



LCB8 Terra Dakota Leather

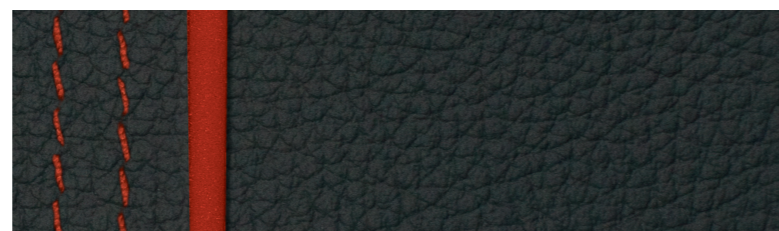

LCL3 Black Dakota Leather / Red highlight



LCOM Oyster Dakota Leather

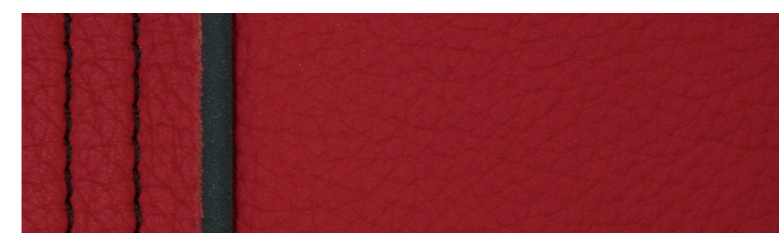

LCL5 Coral Red Dakota Leather / Black highlight

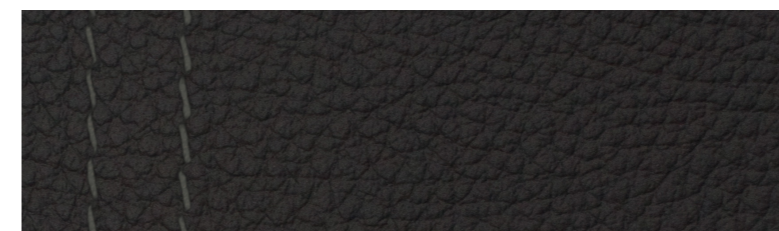

LCSW Black Dakota Leather

2 SERIES COUPE

INTERIOR TRIMS



4GD Black high-gloss trim /
Oxide Silver highlight



4FT Brushed Aluminum trim /
Black high-gloss highlight



4WF Aluminum Hexagon trim /
Estoril Blue matte highlight



4WG Aluminum Hexagon trim /
Black high-gloss highlight



4LC Fineline Stream Wood trim /
Oxide Silver matte highlight



4LV Black high-gloss trim / Coral Red
matte highlight

2 SERIES COUPE

WHEELS / TIRES



Double Spoke Ferric Gray light alloy wheels (Style 384)

18 x 7.5 front, 18 x 8.0 rear; and 225/40 front, 245/35 rear non-run-flat Michelin® Pilot Super Sport performance tires^{1,2,3}



Double Spoke light alloy wheels (Style 384)

18 x 7.5 front, 18 x 8.0 rear; and 225/40 front, 245/35 rear performance tires^{1,2,3}

18 x 7.5 front and rear; and 225/40 front and rear all-season tires¹



Double Spoke Ferric Gray light alloy wheels (Style 461M)

18 x 7.5 front, 18 x 8.0 rear; and 225/40 front, 245/35 rear non-run-flat Michelin® Pilot Super Sport performance tires^{1,2,3}



Double Spoke light alloy wheels (Style 461M)

18 x 7.5 front, 18 x 8.0 rear; and 225/40 front, 245/35 rear non-run-flat summer tires^{1,2}

18 x 7.5 front and rear; and 225/40 front and rear all-season tires¹



Double Spoke Orbit Gray light alloy wheels (Style 436M)

18 x 7.5 front, 18 x 8.0 rear; and 225/40 front, 245/35 rear non-run-flat summer tires^{1,2}

18 x 7.5 front and rear; and 225/40 front and rear all-season tires¹



Double Spoke light alloy wheels (Style 436M)

18 x 7.5 front, 18 x 8.0 rear; and 225/40 front, 245/35 rear non-run-flat summer tires^{1,2}

18 x 7.5 front and rear; and 225/40 front and rear all-season tires¹



Star Spoke light alloy wheels (Style 379)

17 x 7.5 front and rear; and 225/45 front and rear all-season tires¹

¹ Does not come equipped with spare wheel and tire.

² Driving over rough or damaged road surfaces, as well as debris, curbs and other obstacles, can cause serious damage to wheels, tires and suspension parts. This is more likely to occur with low-profile tires, which provide less cushioning between the wheel and the road. Be careful to avoid road hazards and reduce your speed, especially if your vehicle is equipped with low-profile tires.

³ Performance tires include Mobility Kit; not recommended for driving in ice and snow conditions.

Not all features are available on all models. Get the latest information on standard and optional features, packages and technical specifications. Visit bmwusa.com and select the BMW model of your choice.

2 SERIES COUPE

PACKAGES

COLD WEATHER PACKAGE

Heated steering wheel
Heated front seats
Retractable headlight washers

DRIVER ASSISTANCE PACKAGE

Rear-view Camera
Park Distance Control

DRIVER ASSISTANCE PLUS

Automatic high beams
Active Driving Assistant²
Speed Limit Info

LIGHTING PACKAGE¹

Xenon headlights
Adaptive light control

TRACK HANDLING PACKAGE¹

18-inch Double Spoke Ferric Gray wheels (Style 384)
(options available)
M Sport brakes
Adaptive M Suspension
Variable Sport Steering

M SPORT PACKAGE¹

18-inch Double Spoke wheels (Style 461M)
(options available)
Aluminum Hexagon trim / Estoril Blue Matte highlight
(options available)
M Sport suspension
M steering wheel
Aerodynamic kit
Rear spoiler
Shadowline exterior trim
Increased top-speed limiter when equipped
with performance tires

LUXURY PACKAGE¹

Fineline Stream Wood trim with
Oxide Silver matte highlight
(options available)

PREMIUM PACKAGE¹

Universal garage-door opener
Comfort Access keyless entry
Moonroof
Automatic-dimming interior rear-view mirror
and driver's-side exterior mirror
Power front seats
Lumbar support
Ambiance lighting
SiriusXM[®] Satellite Radio with 1-year subscription

¹Available only on the 230i and 230i xDrive Coupe and Convertible.

²Active Driving Assistant is not a substitute for the driver's own responsibility in maintaining safe control of the vehicle.

Not all features are available on all models. Get the latest information on standard and optional features, packages and technical specifications. Visit bmwusa.com and select the BMW model of your choice.

2 SERIES COUPE

TECHNICAL DATA



	BMW 230i / 230i xDrive	BMW M240i / M240i xDrive
ENGINE	2.0-liter TwinPower Turbo inline 4-cylinder	3.0-liter M Performance TwinPower Turbo inline 6-cylinder
OUTPUT @ RPM	248 hp @ 5200 / 258 lb-ft @ 1450-4800	335 hp @ 5500 / 369 lb-ft @ 1520-4500
0-60 MPH (sec) ¹	5.3 [5.5] / 5.2	4.4 [4.6] / 4.2
CITY / HIGHWAY / COMBINED MPG	[21/32/25] / 24/33/27	21/32/25 [19/28/22] / 21/31/25

All dimensions in technical drawings are given in inches. Dimensions shown apply to 230i and 230i xDrive Coupe.

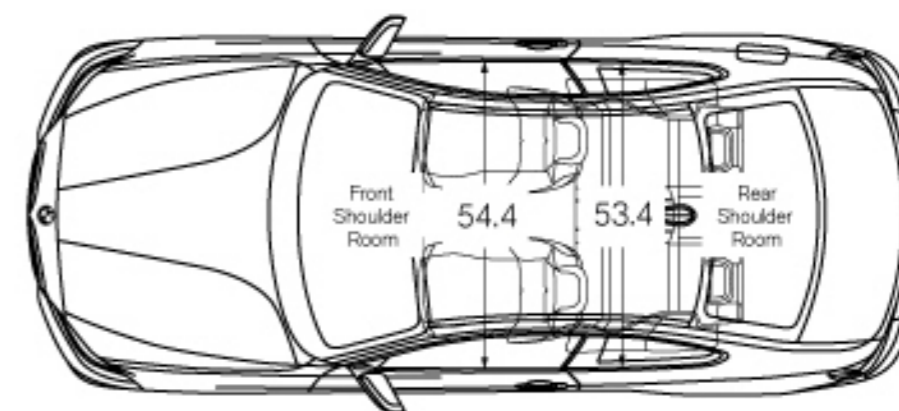
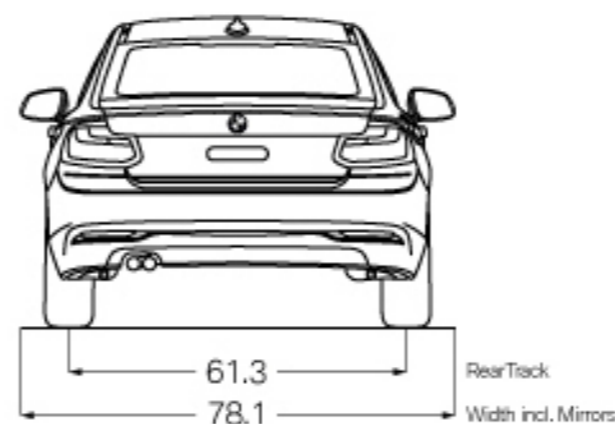
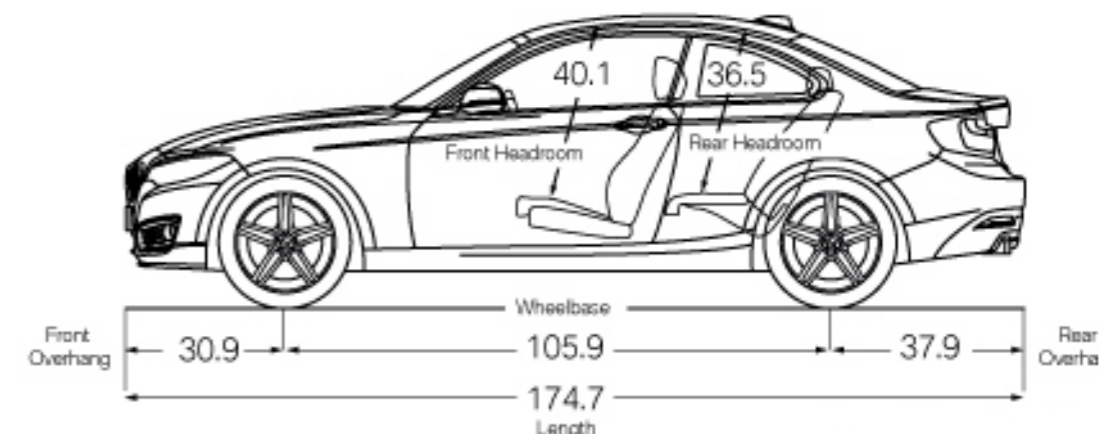
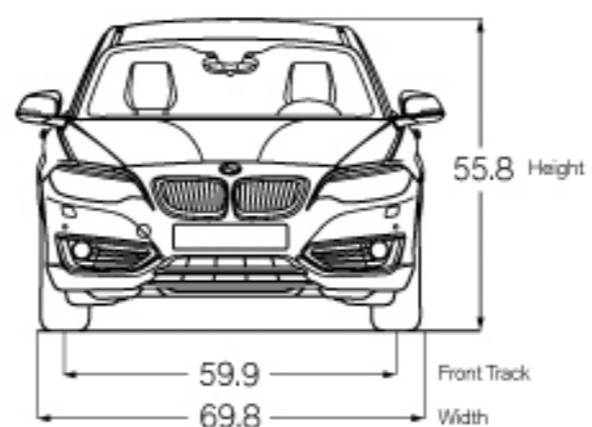

Figures in [] refer to vehicles with manual transmission. Figures subject to change. Not all packages available in all models. Please visit your BMW Retailer or bmwusa.com for the most up-to-date information.

¹BMW AG preliminary test results. Actual acceleration results may vary, depending on specification of vehicle; road and environmental conditions; testing procedures and driving style.

These results should be used for comparison only and verification should not be attempted on public roads. BMW urges you to obey all posted speed laws and always wear safety belts.

Not all features are available on all models. Get the latest information on standard and optional features, packages and technical specifications. Visit bmwusa.com and select the BMW model of your choice.



X Close

SOLAR FLAIR.

With its power-folding softtop that drops in 20 seconds, the 2 Series Convertible adds some sun to the Coupe's blistering performance. Let the wind try to catch up with you for a change.

BMW 2 SERIES CONVERTIBLE

[EXTERIOR COLORS](#)

[UPHOLSTERY](#)

[INTERIOR TRIMS](#)

[WHEELS / TIRES](#)

[PACKAGES](#)

[TECHNICAL DATA](#)



SUN STUNNER.

The 2 Series Convertible may love the sun, but with xDrive intelligent all-wheel drive and a weather-proof softtop, it's always at the ready. Dynamic Stability Control utilizes multiple sensors to measure speed and steering angle to help you maintain control.



A TOP PERFORMER.

Sitting in the BMW 2 Series Convertible reveals the same focus on performance as its Coupe stablemate. You can enjoy the lightning-fast shifts of the 8-speed Sport Automatic transmission, or go the purist route and take control with a 6-speed manual.

2

SERIES CONVERTIBLE

EXTERIOR COLORS

NON-METALLIC

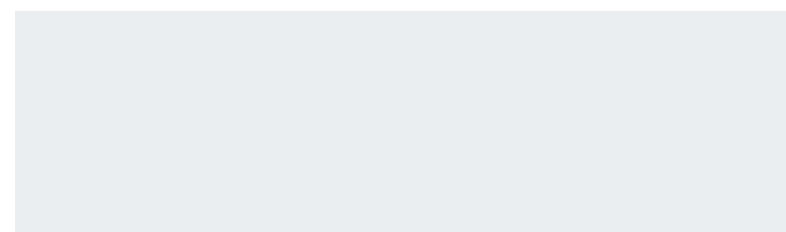

300 Alpine White (Non-metallic)

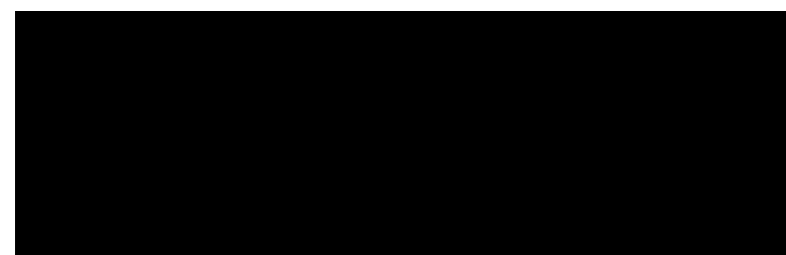

668 Jet Black (Non-metallic)

METALLIC

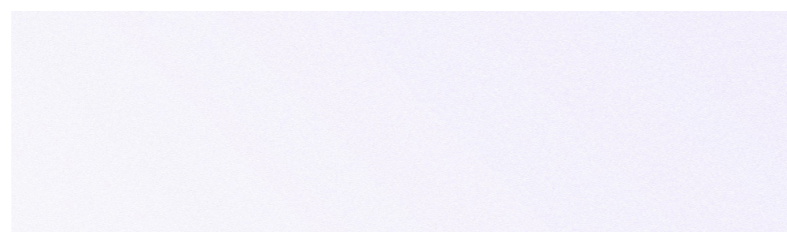

A96 Mineral White Metallic

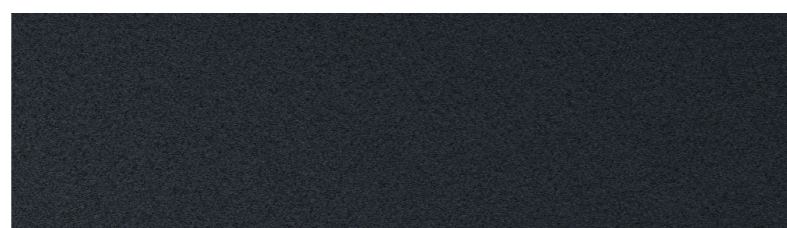

B39 Mineral Gray Metallic



A83 Glacier Silver Metallic

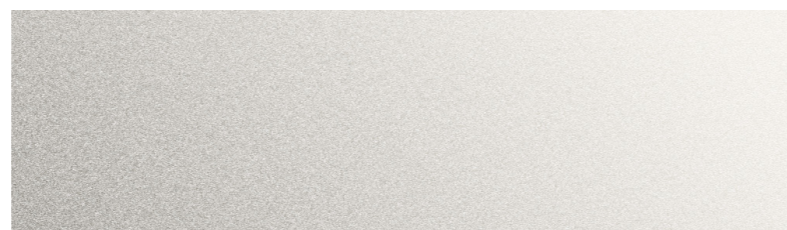

B66 Moonlight Silver Metallic

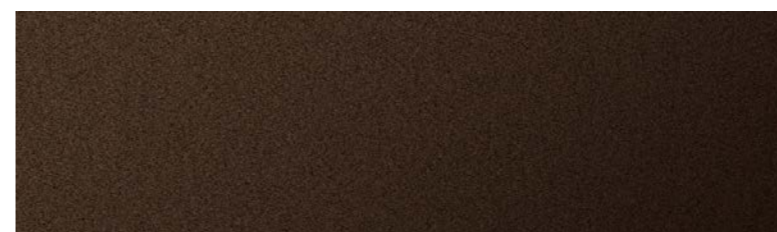

B53 Sparkling Brown Metallic

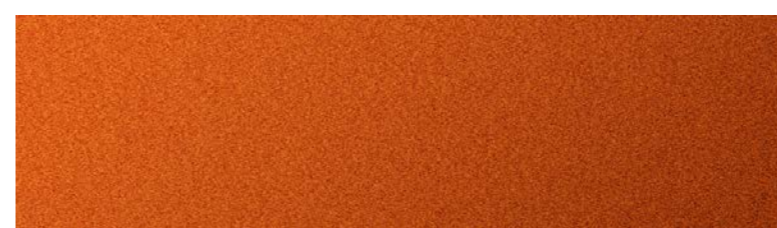

B44 Valencia Orange Metallic



B38 Midnight Blue Metallic



A76 Deep Sea Blue Metallic

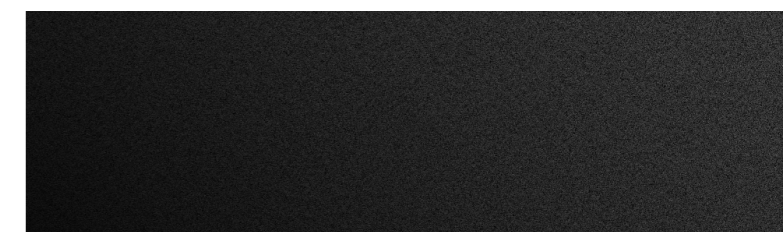

475 Black Sapphire Metallic



A75 Melbourne Red Metallic

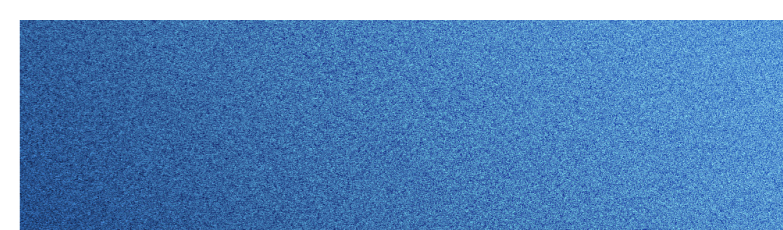

B45 Estoril Blue Metallic

2

SERIES CONVERTIBLE

UPHOLSTERY

SENSATEC

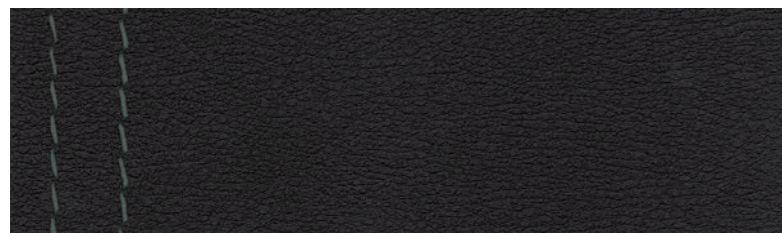

KCSW Black SensaTec

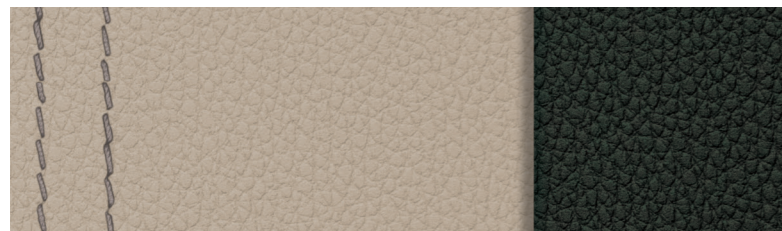

KCCX Oyster / Black SensaTec

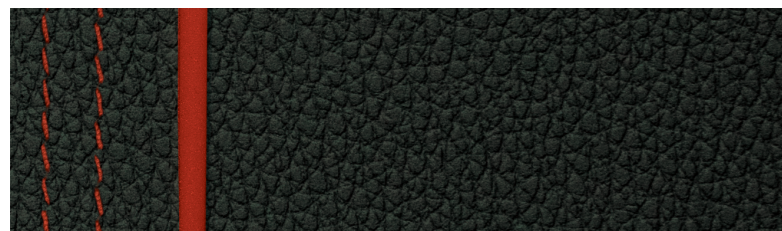

KCL3 Black SensaTec / Red highlight

DAKOTA LEATHER

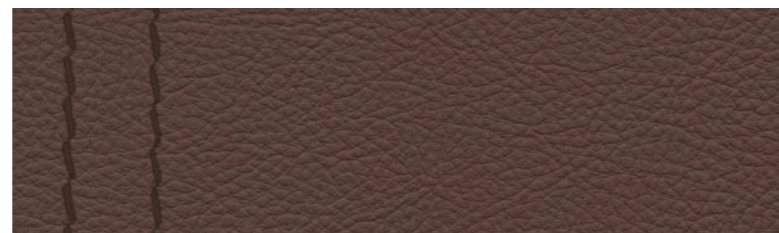

LCB8 Terra Dakota Leather

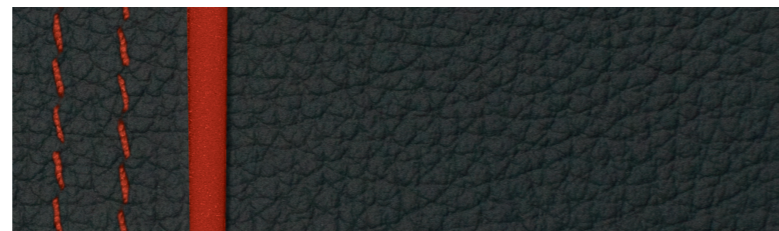

LCL3 Black Dakota Leather / Red highlight



LCOM Oyster Dakota Leather

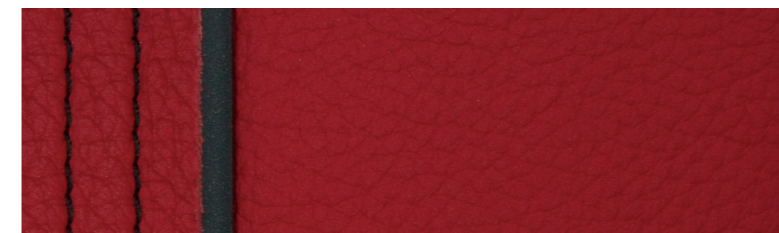

LCL5 Coral Red Dakota Leather /
Black highlight

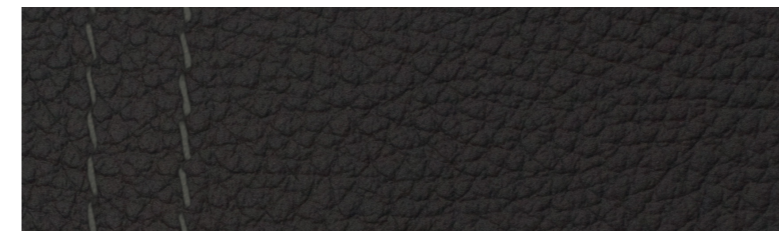

LCSW Black Dakota Leather

2

SERIES CONVERTIBLE

INTERIOR TRIMS



4GD high-gloss Black trim /
Oxide Silver highlight



4FT Brushed Aluminum trim /
high-gloss Black highlight



4WF Aluminum Hexagon trim /
Estoril Blue matte highlight

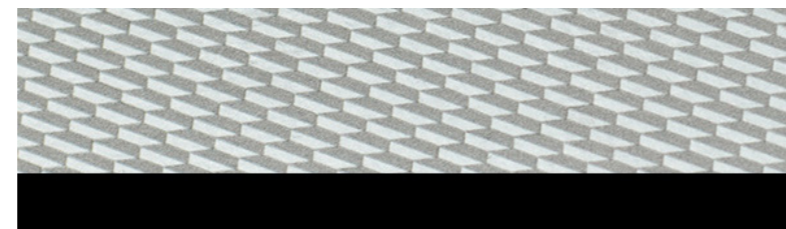

4WG Aluminum Hexagon trim /
high-gloss Black highlight

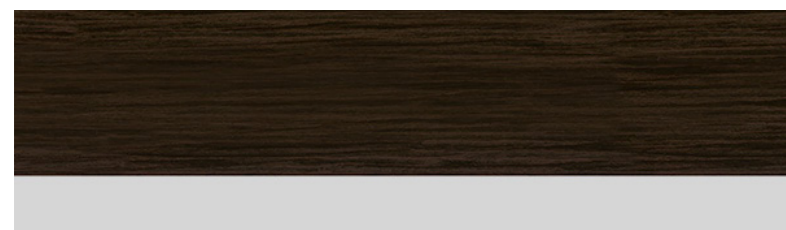

4LC Finline Stream Wood trim /
Oxide Silver matte highlight



4LV high-gloss Black trim / Coral Red
matte highlight

2 SERIES CONVERTIBLE

WHEELS / TIRES



Double Spoke Ferric Gray light alloy wheels (Style 384)

18 x 7.5 front, 18 x 8.0 rear; and 225/40 front, 245/35 rear non-run-flat Michelin® Pilot Super Sport performance tires^{1,2,3}



Double Spoke light alloy wheels (Style 384)

18 x 7.5 front, 18 x 8.0 rear; and 225/40 front, 245/35 rear performance tires^{1,2,3}

18 x 7.5 front and rear; and 225/40 front and rear all-season tires¹



Double Spoke Ferric Gray light alloy wheels (Style 461M)

18 x 7.5 front, 18 x 8.0 rear; and 225/40 front, 245/35 rear non-run-flat Michelin® Pilot Super Sport performance tires^{1,2,3}



Double Spoke light alloy wheels (Style 461M)

18 x 7.5 front, 18 x 8.0 rear; and 225/40 front, 245/35 rear non-run-flat Michelin® Pilot Super Sport performance tires^{1,2,3}

18 x 7.5 front, 18 x 8.0 rear; and 225/40 front, 245/35 rear summer tires^{1,2}



Double Spoke Orbit Gray light alloy wheels (Style 436M)

18 x 7.5 front, 18 x 8.0 rear; and 225/40 front, 245/35 rear non-run-flat summer tires^{1,2}

18 x 7.5 front and rear; and 225/40 front and rear all-season tires¹



Double Spoke light alloy wheels (Style 436M)

18 x 7.5 front, 18 x 8.0 rear; and 225/40 front, 245/35 rear non-run-flat summer tires^{1,2}

18 x 7.5 front and rear; and 225/40 front and rear all-season tires¹

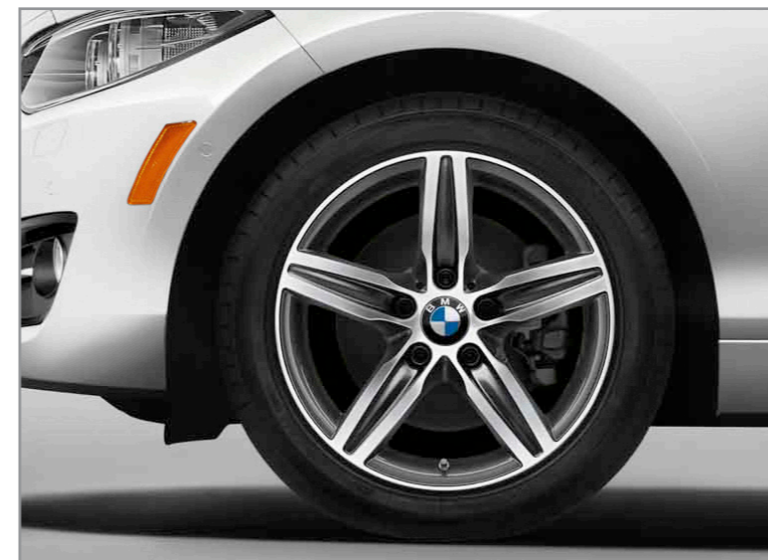

Star Spoke light alloy wheels (Style 379)

17 x 7.5 front and rear; and 225/45 front and rear all-season tires¹

¹ Does not come equipped with spare wheel and tire.

² Driving over rough or damaged road surfaces, as well as debris, curbs and other obstacles, can cause serious damage to wheels, tires and suspension parts. This is more likely to occur with low-profile tires, which provide less cushioning between the wheel and the road. Be careful to avoid road hazards and reduce your speed, especially if your vehicle is equipped with low-profile tires.

³ Performance tires include Mobility Kit; not recommended for driving in ice and snow conditions.

Not all features are available on all models. Get the latest information on standard and optional features, packages and technical specifications. Visit bmwusa.com and select the BMW model of your choice.

2 SERIES CONVERTIBLE

PACKAGES

COLD WEATHER PACKAGE

Heated steering wheel
Heated front seats
Retractable headlight washers

DRIVER ASSISTANCE PACKAGE

Rear-view Camera
Park Distance Control

DRIVER ASSISTANCE PLUS

Automatic high beams
Active Driving Assistant¹
Speed Limit Info

LIGHTING PACKAGE

Xenon headlights
Adaptive light control

TRACK HANDLING PACKAGE

18-inch Double Spoke Ferric Gray wheels (Style 384)
(options available)
M Sport brakes
Adaptive M Suspension
Variable Sport Steering

M SPORT PACKAGE

18-inch Double Spoke wheels (Style 461M)
(options available)
Aluminum Hexagon trim / Estoril Blue Matte highlight
(options available)
M Sport suspension
M steering wheel
Aerodynamic kit
Shadowline exterior trim
Increased top-speed limiter when equipped
with performance tires

LUXURY PACKAGE

Fineline Stream Wood trim with
Oxide Silver matte highlight
(options available)

PREMIUM PACKAGE

Universal garage-door opener
Comfort Access keyless entry
Automatic-dimming interior and driver's exterior mirror
Auto-dimming rear-view mirror
Power front seats
Lumbar support
Ambient lighting
SiriusXM[®] Satellite Radio with 1-year subscription

¹Active Driving Assistant is not a substitute for the driver's own responsibility in maintaining safe control of the vehicle.

Not all features are available on all models. Get the latest information on standard and optional features, packages and technical specifications. Visit bmwusa.com and select the BMW model of your choice.

2 SERIES CONVERTIBLE

TECHNICAL DATA



	BMW 230i / 230i xDrive	BMW M240i / M240i xDrive
ENGINE	2.0-liter TwinPower Turbo inline 4-cylinder	3.0-liter M Performance TwinPower Turbo inline 6-cylinder
OUTPUT @ RPM	248 hp @ 5200 / 258 lb-ft @ 1450-4800	335 hp @ 5500 / 369 lb-ft @ 1520-4500
0-60 MPH (sec) ¹	5.6	4.5 [4.7] / 4.4
CITY / HIGHWAY / COMBINED MPG	23/34/27 / 23/33/26	21/32/25 [19/29/23] / 21/31/25

All dimensions in technical drawings are given in inches. Dimensions shown apply to 230i and 230i xDrive Convertible.

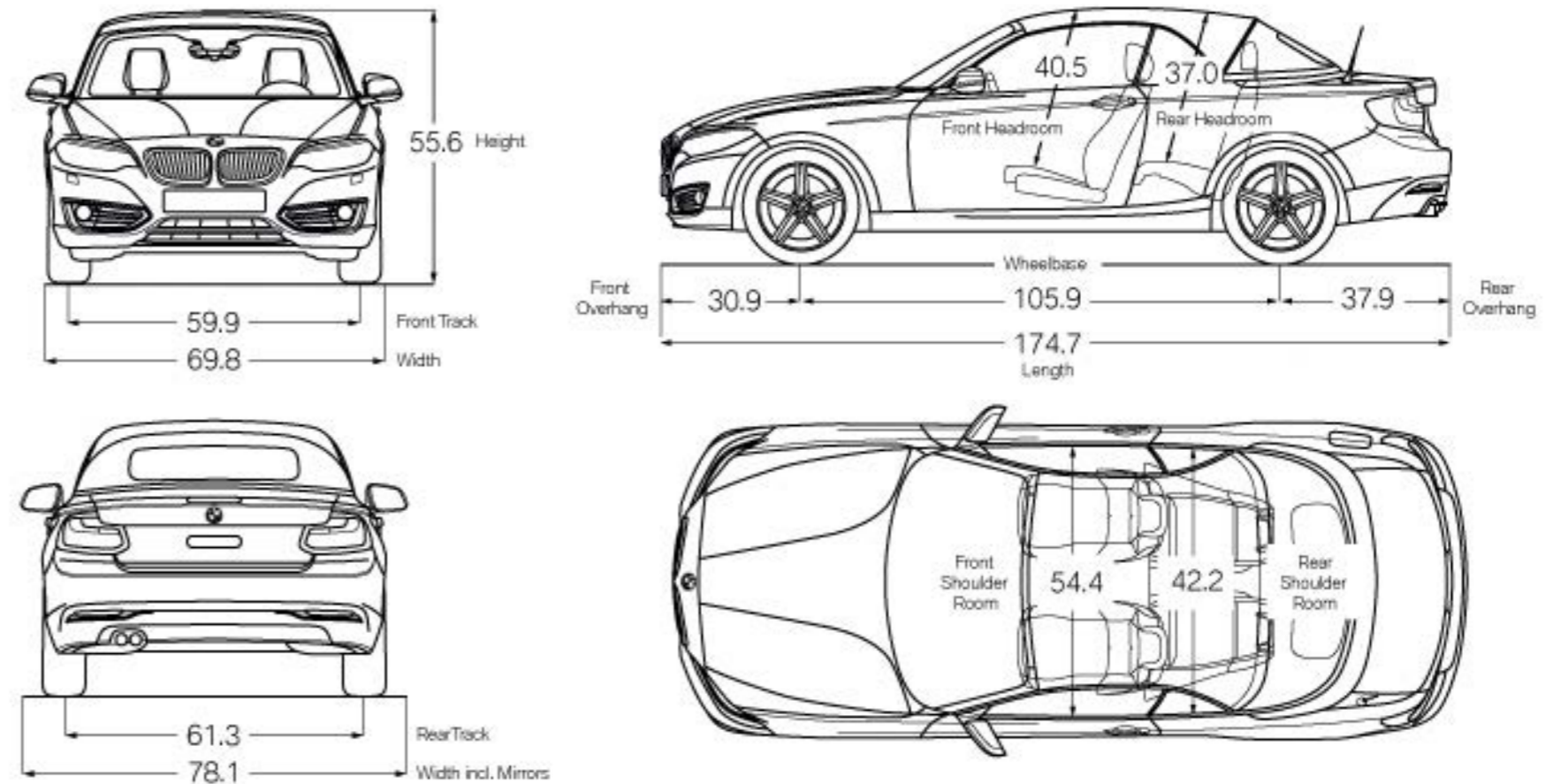

Figures in [] refer to vehicles with manual transmission. Figures subject to change. Not all packages available in all models. Please visit your BMW Retailer or bmwusa.com for the most up-to-date information.

¹BMW AG preliminary test results. Actual acceleration results may vary, depending on specification of vehicle; road and environmental conditions; testing procedures and driving style.

These results should be used for comparison only and verification should not be attempted on public roads. BMW urges you to obey all posted speed laws and always wear safety belts.

Not all features are available on all models. Get the latest information on standard and optional features, packages and technical specifications. Visit bmwusa.com and select the BMW model of your choice.