

CHRYSLER

2001 TOWN & COUNTRY/VOYAGER



The turning point has arrived. A different direction. A new and unexpected road in automotive progress. It's the next generation of Chrysler minivans for 2001. And they are unlike any other. There's better performance and more new features.

New engineering and design priorities. A high level of quality throughout and a wide choice of models. Our 17-year heritage, sales of over 8.5 million and more than 130 awards, have brought us to this point. And for 2001, Automotive Marketing Consultants, Incorporated (AMCI) has reported:

CHRYSLER TOWN & COUNTRY...THE BEST MINIVAN EVER*

CONTENTS

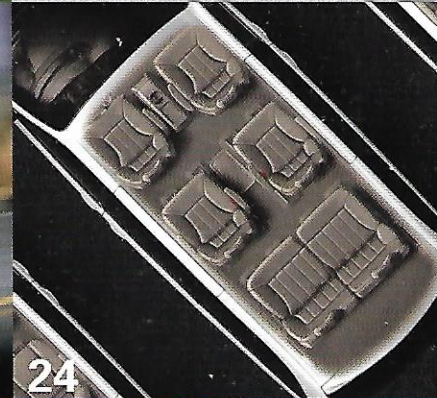

The Best Minivan...

Town & Country has been judged:
"The best minivan ever."* 6

TOWN & COUNTRY

The extended-wheelbase minivan
that achieves the pinnacle of luxury. 10

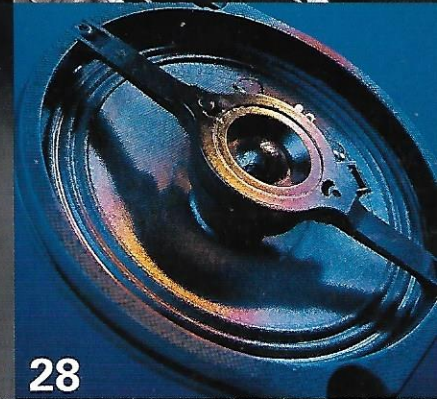

Town & Country/Voyager

A Common Bond of Features...

Versatility 24

Safety & Security 26

Structure & Quiet 28

Engineering 30

Features & Options/Mopar 32



VOYAGER

The standard-wheelbase minivan
that's ready for active families 34



Town & Country/Voyager

Specifications 44



CHRYSLER TOWN & COUNTRY...THE BEST MINIVAN EVER*





**"DaimlerChrysler's model year 2001 minivans...are new right
down to the lug nuts...they are evolutionary in every way."**

—Popular Science • March 2000



New front suspension refinements



CHRYSLER TOWN & COUNTRY

Even when you've taken the world's best-selling minivans a giant leap forward with a variety of improvements, enhancements and a host of new industry-first features, there may still be doubting Thomases. So this year, Automotive Marketing Consultants, Incorporated (AMCI) was asked to undertake an evaluation of minivans in order to determine which minivan was the best minivan ever. For 18 years, AMCI has been accumulating expertise in assessing vehicle dynamics and evaluating automotive marketing. An exhaustive examination of minivans sold in North America was conducted to determine which vehicles would be qualified to participate in the study. The final goal, after thousands of hours of painstaking analysis, was to create a list of



Four-wheel disc antilock brakes

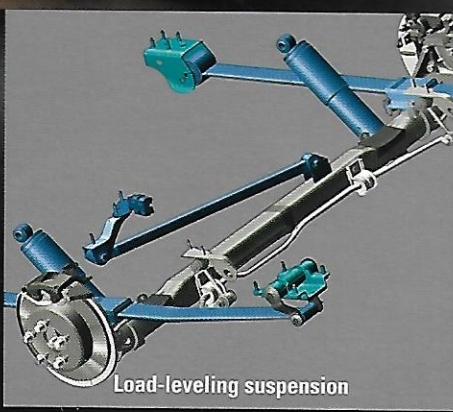

Load-leveling suspension

Quiet, firm and stable structure

...THE BEST MINIVAN EVER*

evaluation documenting the best minivan ever. It was determined that the best minivan ever should combine the overall features that make it comfortable, quiet, versatile, functional and safe. Each vehicle was appraised on individual characteristics in seven categories: active safety; passive safety; noise, vibration and harshness; economy and quality; interior roominess; utility; comfort and convenience. Overall, the best minivan ever ultimately had to meet those expectations better than its competitors. And after the evaluative dust settled, the Chrysler Town & Country was identified as the best minivan ever. If you would like to receive additional information on this evaluation, please call toll-free: 1-877-PROVE-IT.



*Based on AMCI overall weighted evaluations of 2001 Town & Country versus similarly equipped 2000 model year minivans. Call 1-877-PROVE-IT for details.



New available power liftgate



New available movable center console with power outlet

THE ALL-NEW 2001 CHRYSLER M

The benefits of Chrysler's new minivan features and refinements are everywhere—inside and out.* The new industry-first power liftgate comes to your rescue when your arms are filled with grocery bags. The push of a button on the multifunction key fob opens and closes the liftgate at your command. New available Three-Zone Automatic Temperature Control is a minivan-first feature that allows separate regulation of the temperature for the driver, front passenger and rear occupants. A major coup of ingenuity is fingertip close with Chrysler's redesigned overhead console. You'll find a roomy Versa Bin™ storage compartment, plus compass, temperature display, switches for optional power features and many more items. There's impressive power underfoot with a new redesigned and whisper-quiet 3.8-liter V6 engine that delivers 215 horsepower.

New available supplemental front-seat side air bags*



New available rear cargo organizer





New available Three-Zone Automatic Temperature Control

ANS ... OUR BEST MINIVANS YET

New power sliding doors will quickly become one of your favorite features. Powered by the industry's first inside-the-door motors, opening and closing the left or right sliding door takes only a few seconds. (Doors can also be operated manually.) Includes Obstacle Detection System opening or closing. A new available rear cargo organizer* adds functionality and versatility to the area behind the rear seats. For increased safety, new available supplemental front-seat side air bags† provide additional side-impact protection. Chrysler's new movable center console with a 12-volt power outlet offers incredible convenience and versatility. This industry-first feature is used between the front seats or the intermediate Quad Command bucket seats.

*Feature availability depends on model choice. Some equipment may be optional. See your dealer for details.
†Late availability. Available only on Town & Country models.
‡Always use seat belts. Children 12 and under should always be in a backseat correctly using an infant or child restraint system, or a seat belt that is right for their age and size.



Available overhead console with Versa-Bin™

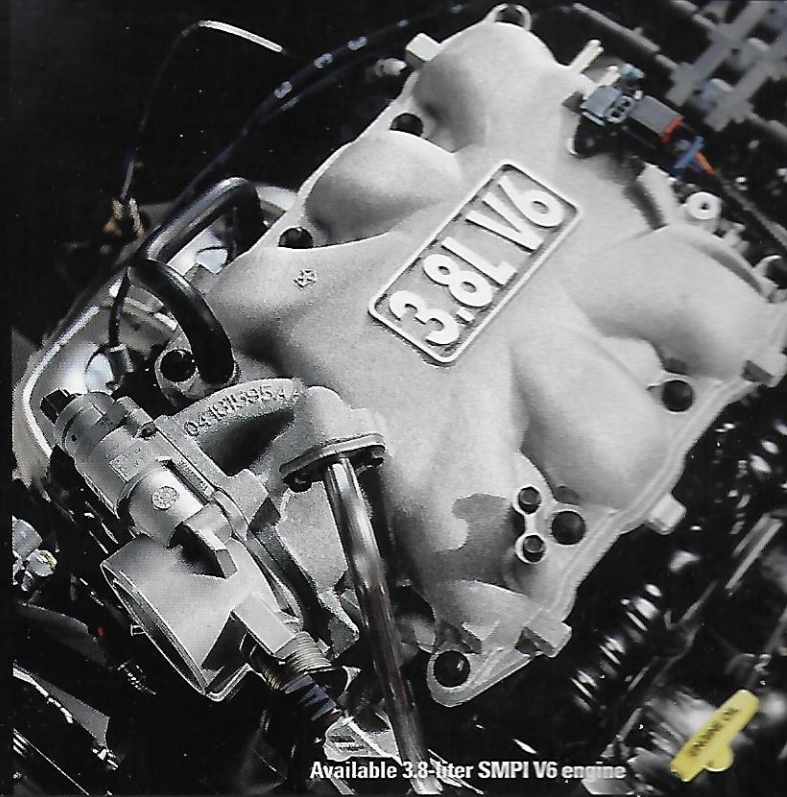

Available 3.8-liter SMPI V6 engine

New available power sliding doors



TOWN & COUNTRY



Loaded with enough smart industry firsts to help Dodge Chrysler rank in No. 1 position in the minivan segment.



CHRYSLER

Town & Country Limited in Bright Silver Metallic

Town & Country. It is a name that has come to exemplify luxury in a minivan. For 2001, the extended-wheelbase

Town & Country continues to distinguish itself as one of the world's most advanced and sophisticated minivans.

From its



Town & Country Limited

leading-edge styling to its redesigned and ultra-quiet 3.8-liter V6

engine, Town & Country Limited is a refreshing alternative to

the commonplace. One look will tell you that Chrysler engineers

have carefully scrutinized the techniques of creating the most comfortable and elegant driving environment

possible. With Preferred Suede® appointments, leather-trimmed seven-passenger seating and available power

heated eight-way driver and front-passenger seats, it has enough opulence to complement evening wear and a

TOWN & COUNTRY*

night at the ballet. And this elegance is reflected in the craftsmanship of fine

touches, such as inside chrome door handles, distinctive instrument cluster graphics and the richness of a leather-

wrapped steering wheel. Town & Country LXi offers the convenience

of remote keyless entry, automatic temperature control, standard

50/50 split-bench rear seat, standard power sliding doors and a new

available rear cargo organizer¹ that adds functionality to the area behind the rear seats. Behind the wheel, you'll

motor with LXi's 3.3-liter V6, available Low-Speed Traction Control and available load-leveling and height-control

suspension system for a smooth and even vehicle stance. Town & Country LX offers outstanding versatility with

its extended wheelbase (200.5 inches overall length). LX has the available features to satisfy your individual

needs, while respecting your budget.

conditions, you'll be glad to



And best of all, in inclement driving

know that all-wheel drive is



Town & Country LXi



Leather-wrapped steering wheel



50/50 split-bench rear seat



Standard easy-entry intermediate bucket seats

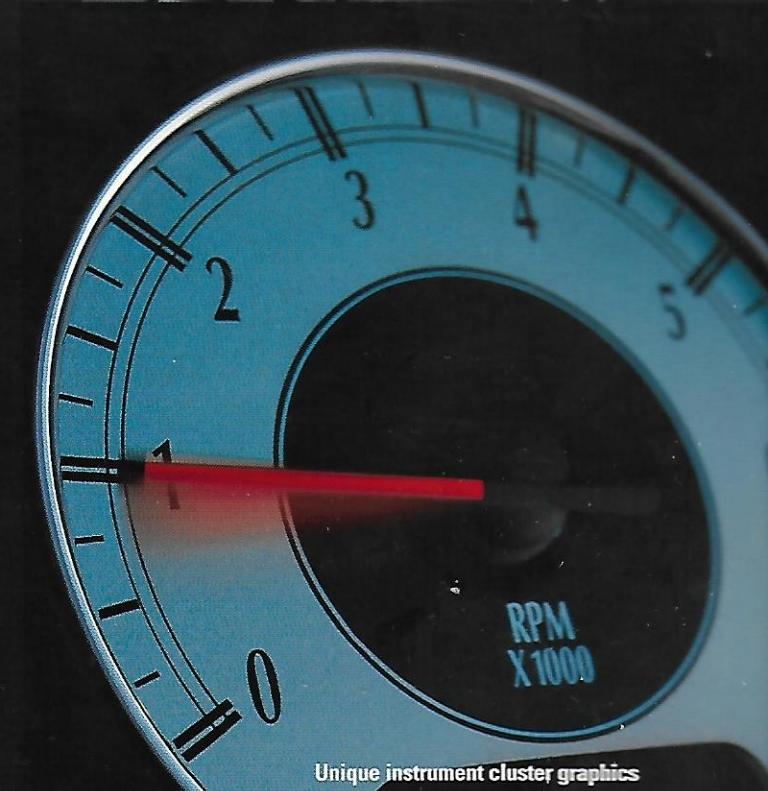

Unique instrument cluster graphics

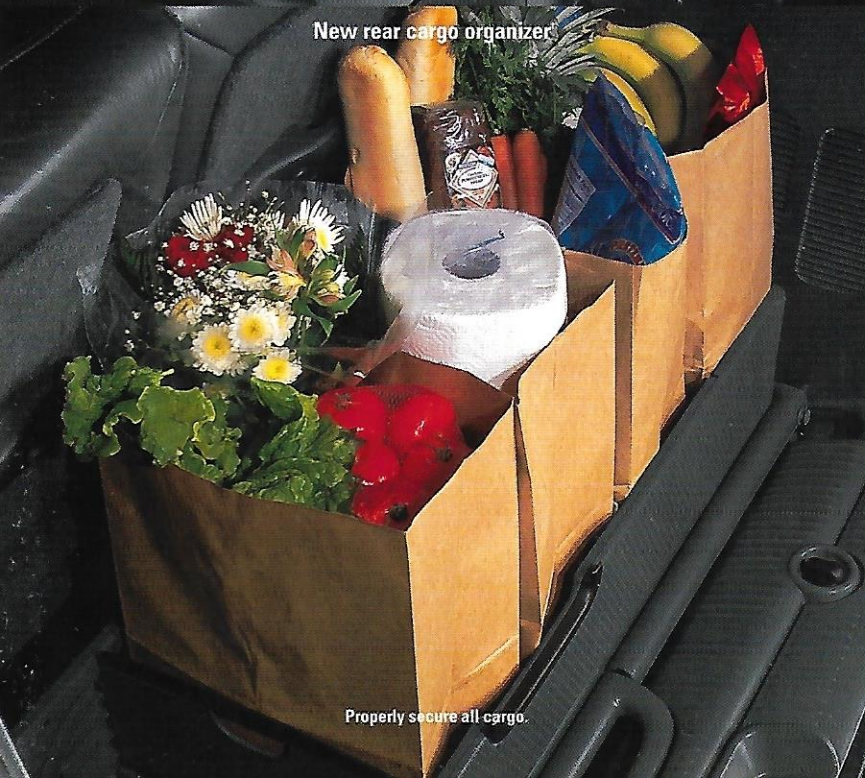

New rear cargo organizer

Properly secure all cargo.

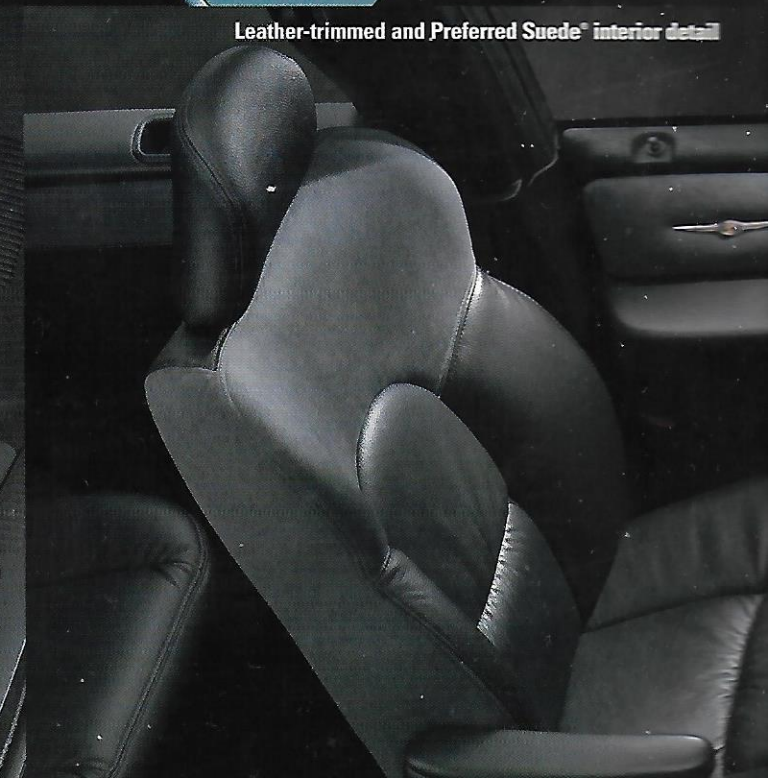

Leather-trimmed and Preferred Suede® interior detail



ON
OFF
CRUISE
SET

ACCEL
RESUME
CANCEL
COAST



Town & Country limited interior in Navy Blue leather-trimmed seats. 24.995 MSRP. MSRP includes destination charge, tax, license, and title. Dealer price may vary.





Town & Country Limited interior in Navy Blue leather-trimmed seating with Preferred Seating[®] interior





CHRYSLER

Town & Country LXi in Steel Blue Pearl Co





Town & Country LX in Inferno Red Tinted Pearl Coat





Town & Country LX cloth interior in Taupe

TOWN & COUNTRY/VOYAGER

Very versatile and exceptionally functional. That's the only way to describe the wide variety of seating configurations and thoughtful convenience items in every Chrysler Town & Country and Voyager. The very

VERSATILITY*

spacious, highly functional interior welcomes the driver with an available ultra-

comfortable eight-way power adjustable driver's seat (and programmable settings for two

on Limited). Open the liftgate and the sliding doors, and you'll see enough interior space to

cater to your longest getaway weekend. With its extended wheelbase, Town & Country offers a massive 167.9

cubic feet of cargo volume with the middle and rear seats removed. And in the same mode, every Voyager

model provides 146.7 cubic feet. Then there are all the storage and convenience features you can use, such as

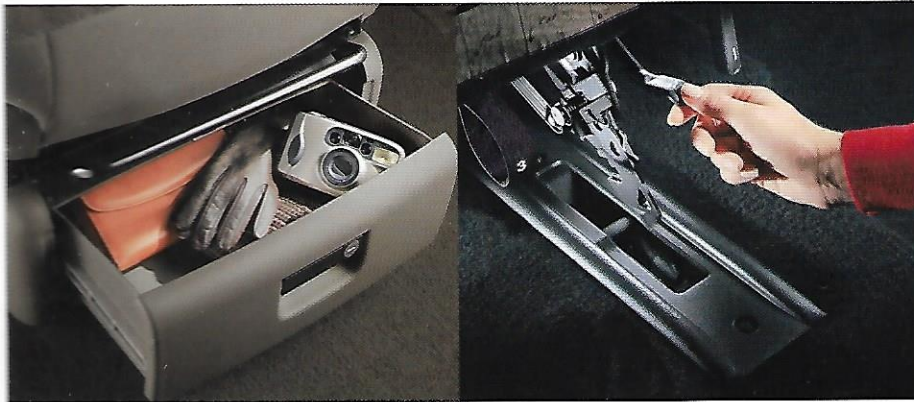

a near-at-hand lockable storage drawer under the front-passenger

nonpower seat to hold valuables. Cup holders so everyone can take

along their favorite beverage. Third-row seatback grocery

bag/utility hooks. A cargo net between the two front seats for holding small items. And thanks to a ratchet-

type swing-out holder, front center instrument panel console cup holders (below) can accommodate almost

any size drink container

There's plenty of room



securely. So load up your Chrysler minivan—and go!

and enough seating combinations to fit your exact

Bench Easy Out® Roller Seats are simple to remove with aircraft-style wheels. Intermediate Quad Command Easy Out Roller bucket seats weigh less than 50 pounds each, and can be individually carried or easily rolled to your storage area. What could be more convenient?





TOWN & COUNTRY/VOYAGER

At Chrysler, every minivan is meticulously equipped and rigorously tested to help maximize the protection of every occupant. Chrysler minivans are designed from the start to surround you with safety. Driver and front-passenger front air bags; when used in conjunction with front three-point Unibelt seat belts with pretensioners, are one of the best safety systems available today. Available supplemental front-seat side air bags* provide enhanced head and thorax protection for a properly positioned driver and front passenger in the event of a side impact. Power-assisted four-wheel disc antilock brakes, standard on Town & Country, have new stiffer calipers that are 20 percent larger to improve pedal



feel and provide more linear response. For increased safety and driver confidence, available Low-Speed



Side-guard door beams (far left) help provide protection in side-impact collisions. New lower anchor points (middle) for aftermarket child safety seats help you avoid improper installation. The available Integrated Child Safety Seat is located in the passenger-side intermediate bucket seat†

Tractive Control senses overspin on the front driving wheels and applies braking power for better grip at

speeds up to 35 mph. For 2001, Chrysler minivans feature an all-new

SAFETY & SECURITY

body structure to help improve the energy-absorbing character of the vehicle. Crumple zones work by

progressively compressing to absorb energy from front and rear impacts. An available remote

keyless entry includes common lock and unlock functions, plus controls to open and close the

available power liftgate and both power sliding doors. The key fob also includes a panic alarm that

makes walking to your parked minivan a safer situation. With all of



A redesigned all-wheel-drive system
with reduced weight and complexity
is available on all 2001 Town & Country
models for better directional stability
and confident steering in inclement
driving conditions.

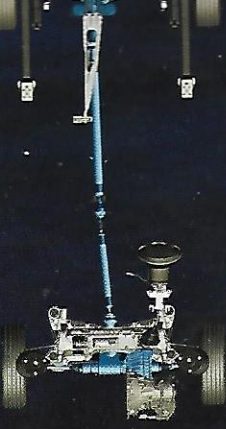

TOWN & COUNTRY/VOYAGER

The best is even better. *And quieter.* For 2001, Town & Country and Voyager are substantially quieter and more refined than ever before. A new body structure contributes to solid ride and handling characteristics through rigid support, while minimizing noise transmission and road

STRUCTURE & QUIET

harshness. In addition to the benefits of a quieter ride, modifications to the

underbody structure, the front longitudinal rails

and the addition of a reinforcement extension

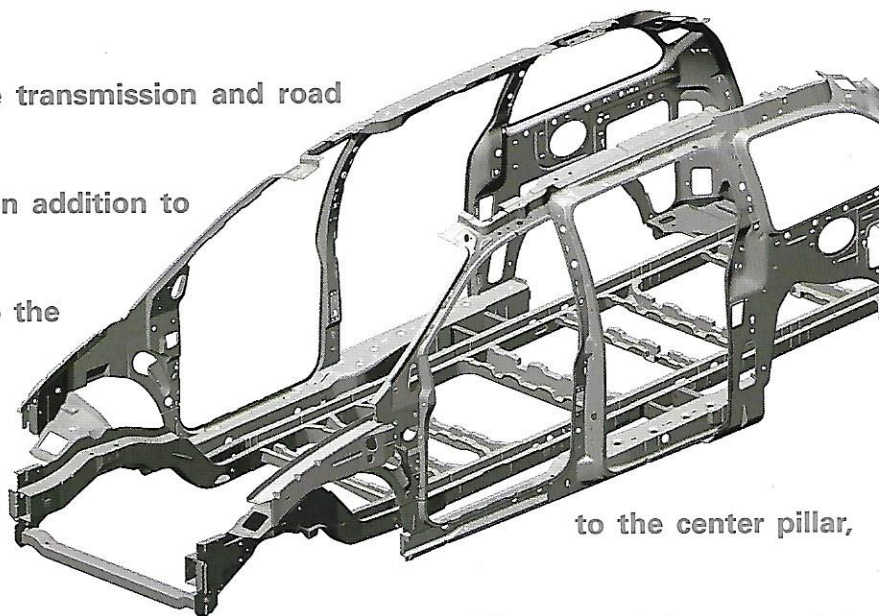

to the center pillar,

contribute to improved offset-impact protection and side-impact protection. Liftgate and doors receive

special attention to block out the din of the traffic. Sound-Loc door liners and seals work in conjunction

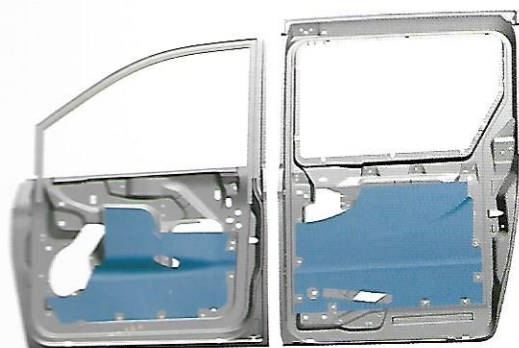

with the trim panels to reduce noise inside door cavities. New Ultra

Light™ acoustic materials in the headliner, dash panel, under the

carpeting and in the wheelhouses provide

superb sound dissipation and absorption. In fact, the interior noise level is

low enough to permit effective speech intelligibility throughout the minivan.

This ultra-quiet interior atmosphere also benefits audiophiles by enhancing the



listening enjoyment of any

of the available Town & Country and Voyager sound

systems. Here are just a

few more refinement techniques: thicker

underhood silencer pad;

molded foam gaskets between

the exterior mirrors and the body;

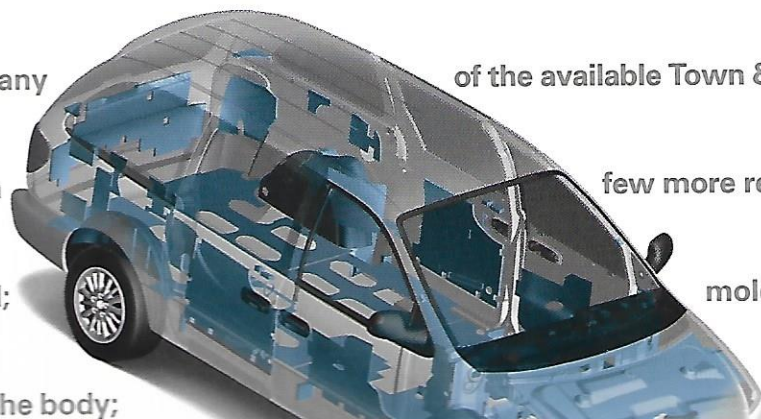

various molded cowl-to-

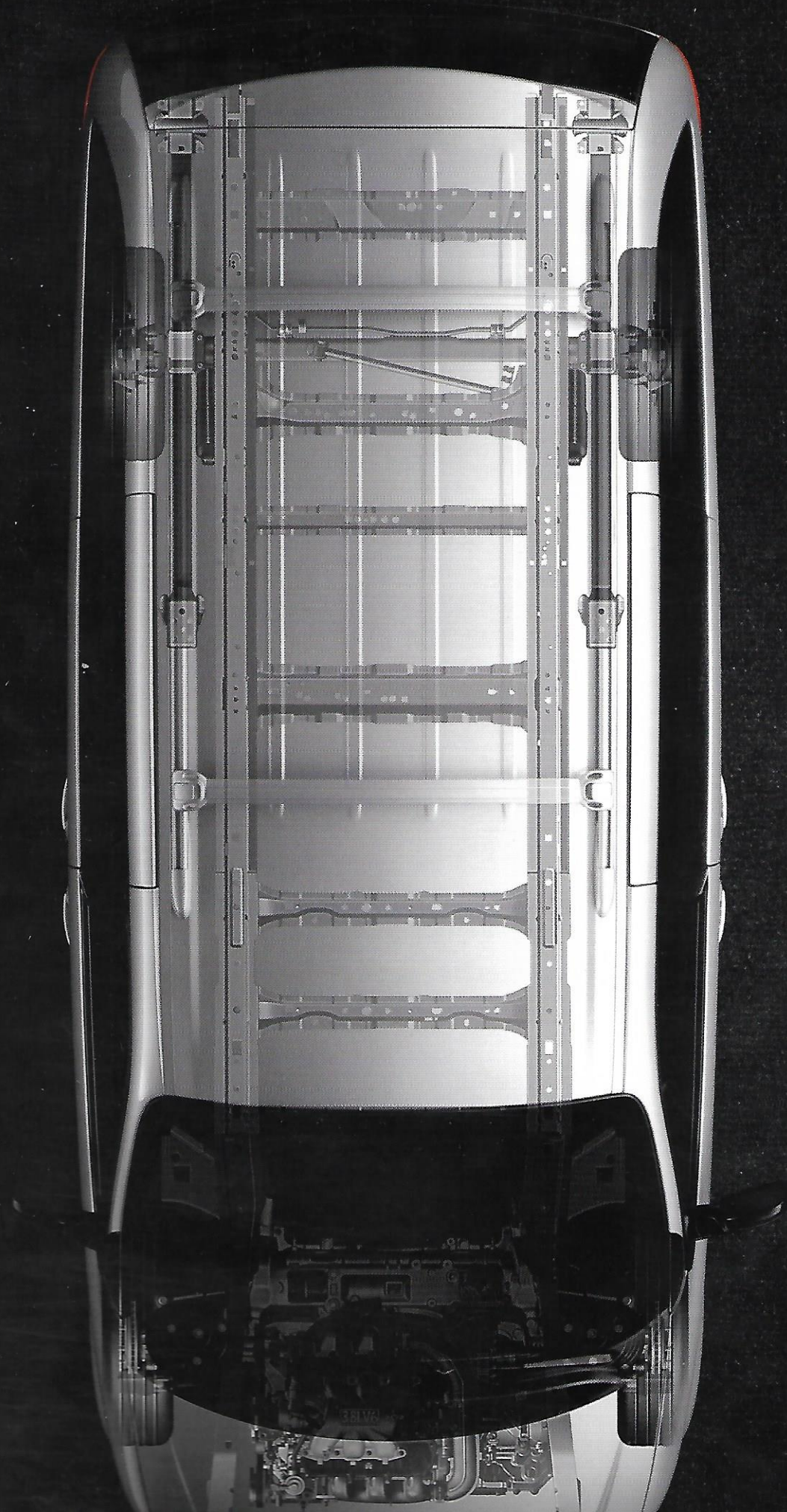

TOWN & COUNTRY/VOYAGER

In every minivan, Chrysler uses sophisticated, innovative engineering to make Voyager and Town & Country agile performers. A beneficial available load-leveling rear suspension system automatically adjusts the minivan's attitude

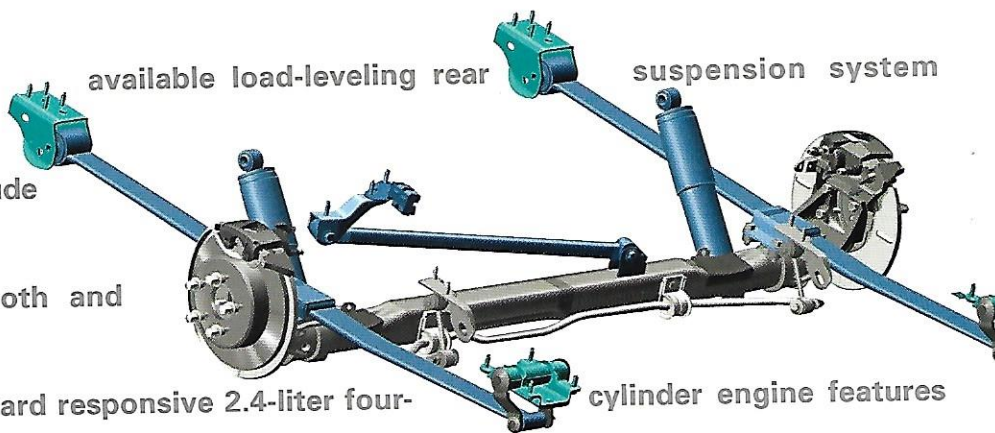

ENGINEERING*

for a very smooth and

steady vehicle stance. Voyager's standard responsive 2.4-liter four-cylinder engine features evolutionary changes that reduce exhaust emissions from within the engine. Additional refinements include increased low-speed torque and more throttle response throughout the speed range. The result is

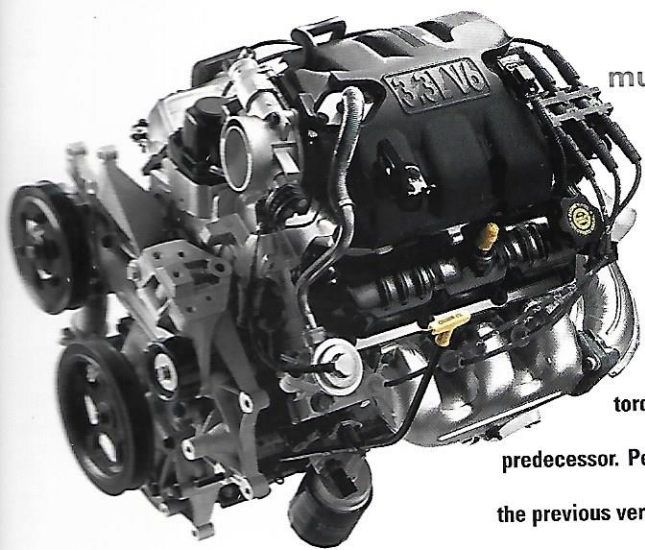

much quieter operation and improved idle quality. For 2001,

Chrysler's aggressive 3.3-liter V6 engine offers expanded power

The completely redesigned 3.8-liter V6 engine provides more power, torque and quieter operation than its predecessor. Peak power is 19 percent more than the previous version—for a total of 215 horsepower. New gaskets and seals in selected areas utilize new technologies to reduce the potential for leakage.

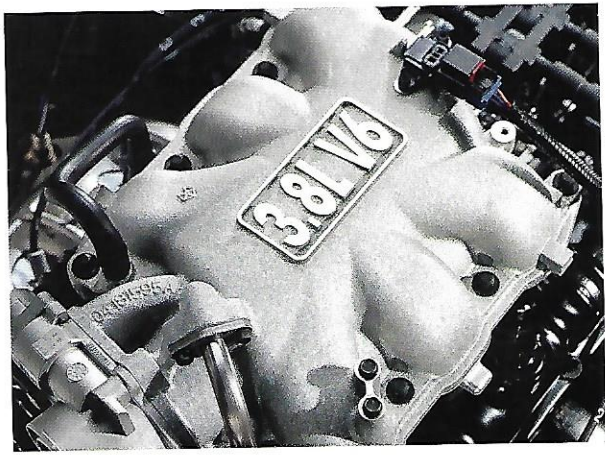

and torque. Horsepower

has been generously increased from 158 horsepower to 180 horsepower. And a 10-percent increase in low-speed torque and more torque at higher speeds result in heightened performance for highway passing

situations. For smooth and optimum operation, all V6 engines are coupled with a refined four-speed automatic transaxle.



The 2.4-liter four-cylinder engine

features a three-speed automatic.

Both front and rear suspensions

handling confidence, improve



TOWN & COUNTRY/VOYAGER

Life is full of options. But choosing the features that let you personalize your new 2001 Chrysler minivan is fun and easy. Your minivan's ultra-quiet interior will be even more enjoyable when you select from a wide range of

FEATURES & OPTIONS*

radios and sound systems. AM/FM stereo radio with cassette and CD

player, equalizer and six speakers (A). AM/FM stereo radio with CD player and

six speakers (B). AM/FM stereo radio with cassette and in-dash four-disc CD

changer and Infinity Acoustic 10™ speakers (C). Chrysler's available premium

quality woofers, tweeters and full-range speakers, are a perfect

complement to your minivan's hushed ambience.

Choose from a variety of Chrysler minivan wheels and wheel covers for a

head-turning look: Town & Country Limited 16-inch

Constellation chrome wheels; Town & Country LXi

available 16-inch Scorpion aluminum wheels; Town &

Country LX 15-inch Solara TC wheel cover; Town & Country LXi 16-inch Chronos

wheel covers; Voyager 15-inch Orbiter wheel covers; and Voyager LX 15-inch Solara

wheel covers. New available movable center console

MOPAR ACCESSORIES

provides power for a cellular telephone and lockable storage. See your dealer for a list of Chrysler accessories

from Mopar. Every Chrysler accessory from Mopar is thoroughly designed for exceptional fit and quality, and

will integrate perfectly with your Town & Country or Voyager minivan. The Mopar Rear Seat Video™ lets

rear-seat passengers enjoy their favorite movies or video games on long trips. Mopar Molded Running Boards

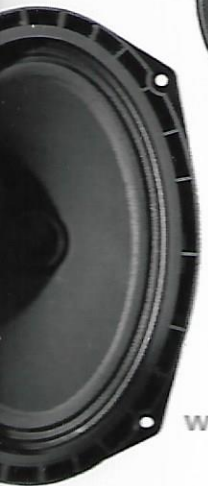
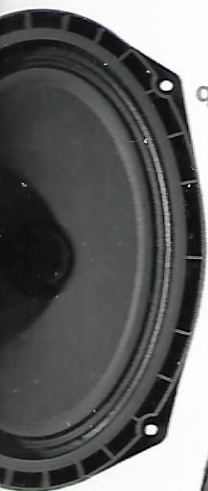



Town & Country Limited 16-inch Constellation chrome wheel



Available movable center console storage



Mopar Rear Seat Video™

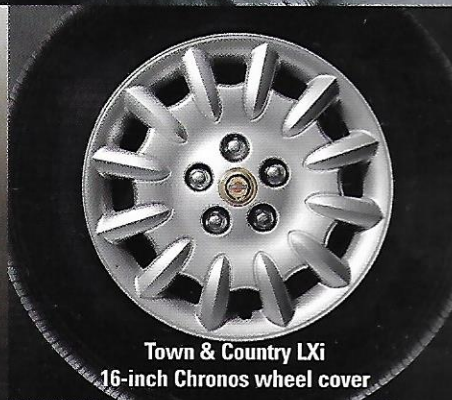

Town & Country LXi
16-inch Chronos wheel cover



Town & Country LX
15-inch Solara TC wheel cover



Voyager LX 15-inch Solara wheel cover



Voyager 15-inch Orbiter wheel cover

Town & Country LXi 16-inch Scorpion aluminum wheel



Mopar Molded Running Boards



VOYAGER





CHRYSLER

Voyager LX in Bright Silver Metal

The all-new standard-wheelbase 2001 Chrysler Voyager LX really lets you and your family go places.

Voyager LX gives you the space you need, the performance and handling you want, and special features to help make the most out of every time you travel. It's ideally equipped with desirable touches, such as standard 3.3-liter V6 engine with four-speed automatic, new available supplemental front-

VOYAGER

seat side air bags, six-speaker sound system, inviting instrumentation detail, available 50/50 split-bench rear seats, speed control, power windows, power door locks, body-color bumpers and more. LX achieves a



Voyager LX

whole new level of refinement with its comfortable and roomy interior, car-like feel and ride, and wide choice of available equipment to best suit your individual needs. Value at its very

best! The all-new standard-wheelbase Chrysler Voyager is a do-it-all minivan that's ready for your active family. Mile after mile, it delivers all of the advantages of a minivan at a superb value. In addition to a

distinctive grille with winged badge detail, Voyager's sleek new styling is enhanced by taillamps that feature red lenses with bright housings for a jewel-like appearance. When the road becomes slippery, Voyager's

available antilock brakes will help you stop or allow you to steer through a skid. For extra passing and towing power, add the available redesigned 3.3-liter V6 engine that puts a potent 180 horsepower at

your command. Available remote keyless entry system offers peace of mind with illuminated entry, panic alarm and

controls for power door locks. Plus, Voyager adapts to the



Voyager

demands of your active lifestyle with a wide choice of seating options to meet your cargo and passenger

requirements. For 2001, Chrysler Voyager is the number one choice for America's most active families.



Winged badge and distinctive grille styling



Available supplemental front-seat side air bags*

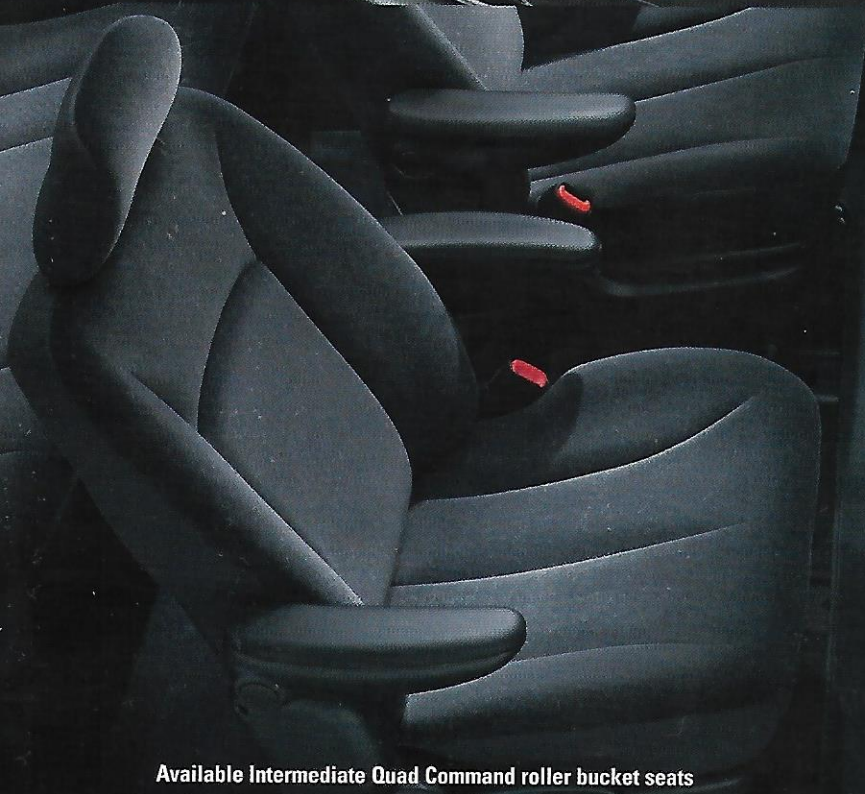

Available Intermediate Quad Command roller bucket seats

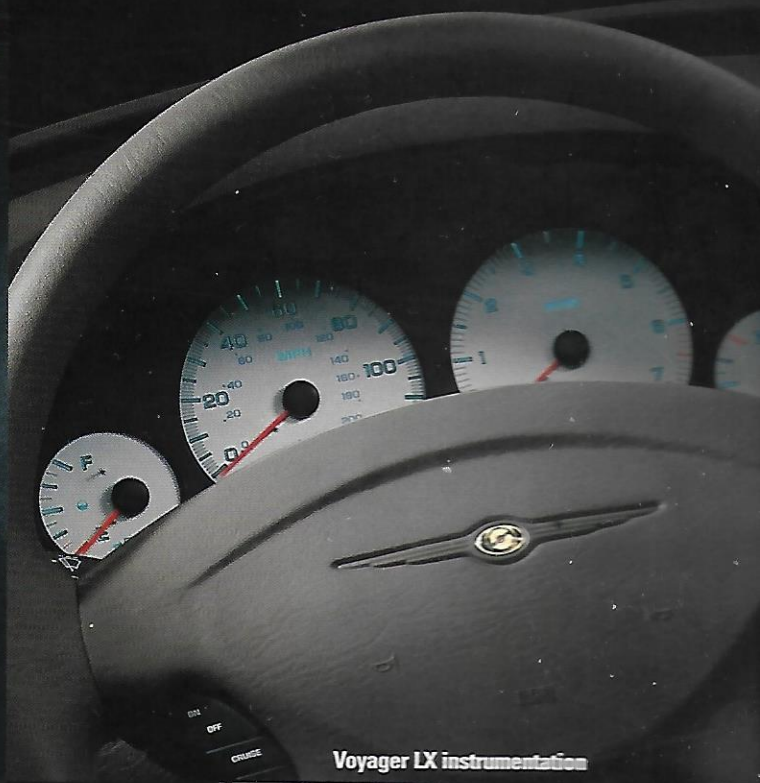

Voyager LX instrumentation

Available four-wheel antilock brakes

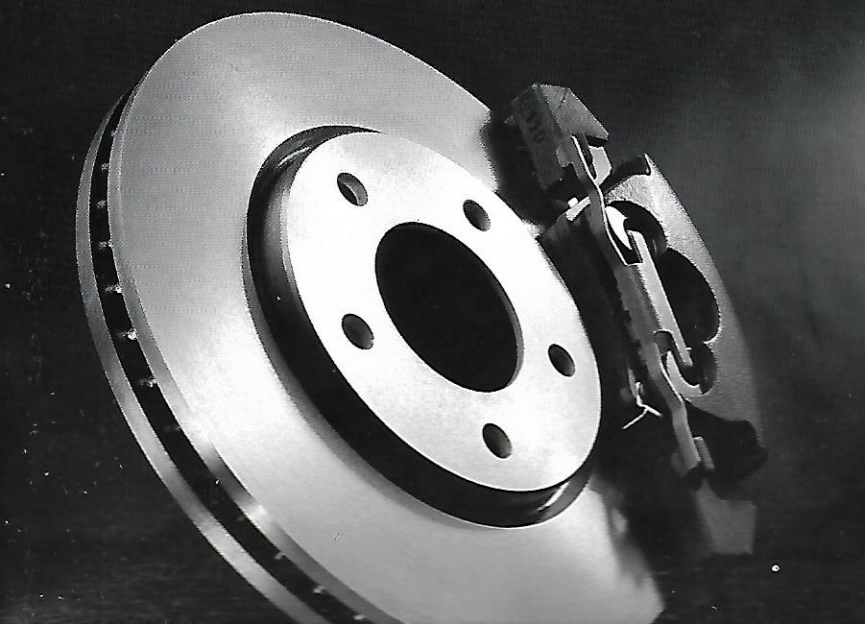

Jewel-like taillamp styling





Voyager in Aquamarine Metal



ON
OFF
CRUISE
SET

ACCEL
RESUME
CANCEL
COAST





Voyager LX cloth interior in Taupe





Voyager LX cloth interior in Navy Blue

PECIFICATIONS

FEATURES, OPTIONS AND PACKAGE GROUPS

		Town & Country						Voyager			
		LX			LXi		Limited	Base	LX		
		2F	2H	2K	2R	2U	2X	2C	2F	2H	2K
Engine	Transaxle							2C	2F	2H	2K
2.4-liter 4-cylinder	3-speed automatic							22C			
3.3-liter V6	4-speed automatic	25F	25H	25K	25R	25U		25C	25F	25H	25K
3.8-liter V6	4-speed automatic			29K	29R	29U	29X				
Air Bags* — Supplemental side for front occupants		○	○	○	○	○	●	○	○	○	○
Air Conditioning											
— Manual		●						●	●		
— Dual zone temperature control with particulate air filter										●	●
— Three-Zone Temperature Control with particulate air filter (included with Climate Group III)		P	●	●							
— Three-Zone Temperature Control (automatic) with particulate air filter					●	●	●				
Alternator											
— 140-ampere		●						●	●	●	●
— 160-ampere			●	●	●	●	●				
Assist Handles — Front and intermediate passengers plus rear assist handles/Limited					●	●	●				
Battery											
— 500-ampere (included with 3.3L V6 engine)		●	●	●	●	●		P	●	●	●
— 600-ampere (included with 2.4L I-4 or 3.8L V6 engine or Trailer Tow Group) (Standard on AWD models)			P	P	P	P	●	●			
Brakes											
— 4-wheel antilock								○	●	●	●
— 4-wheel disc antilock brakes		●	●	●	●	●	●				
Climate Group II — Sunscreen glass		○	●	●	●	●	●	○	○	●	●
Climate Group III — Sunscreen glass, Three-Zone Temperature Control, rear air conditioning and particulate air filter		○	●	●							
Climate Group Three-Zone Automatic Temperature Control — Sunscreen glass, rear air conditioning and particulate air filter					●	●	●				
Consoles											
— Center removable with power outlet			○	○	○	●	●				
— Overhead			●	●						●	●
— Overhead with trip computer					●	●					
— Overhead with EVIC trip computer							●				
Defroster — Electric rear window and windshield wiper de-icer		●	●	●	●	●	●	○	●	●	●
Deluxe Convenience Group — Speed control and tilt steering column								○	●	●	●
Door Locks — Power		●	●	●	●	●	●	○	●	●	●
Doors — Passenger side power sliding door			○	●	●	●	●			○	●
Doors — Driver side power sliding door					●	●	●				
Drivetrain — All-wheel-drive model available				○	○	○	○				
Engine Block Heater		○	○	○	○	○	○	○	○	○	○
Engine Cooling — Heavy-duty (included w/Trailer Tow Group)		○	○	○	○	○	○	○	○	○	○
Floor Mats — Front and rear		●	●	●	●	●	●	○	●	●	●
Fog Lamps					●	●	●				
Glass											
— Tinted		●						●	●		
— Sunscreen and tinted front windows (included with Climate Group II or Climate Group III)		P	●	●	●	●	●	P	P	●	●
HomeLink® Universal Transceiver — Programmable, 3-function, with remote controls for garage door opener, interior/exterior home lighting and security devices					●	●	●				
Instrument Cluster — Tachometer with V6 engine		●	●	●	●	●	●	○	●	●	●
Liftgate — Power (requires remote keyless entry and power passenger sliding door)			○	○	○	○	●				
Light Group — Ignition time delay, glove box and overhead ashtray/cup holder lamps			●	●	●	●	●			●	●
Lighting											
— Exterior											
— Headlamp-off time delay (Standard on AWD)			●	●	●	●	●			●	●
Mirror											
— Interior											
— Automatic day/night includes automatic driver's side outside mirror							●				
— Dual illuminated covered visor vanity (Standard on AWD)			●	●	●	●	●			●	●
— Exterior											

	25F	25H	25K	25R	25U	25C	25F	25H	25K
2.4-liter 4-cylinder						22C			
3.3-liter V6 FFV									
3.8-liter V6			29K	29R	29U	29X			
Rear Cargo Organizer — (Late availability) (Not available on AWD Limited)	○	○	○	○	○	○			
Remote Keyless Entry (with memory feature on Limited)		●	●	●	●	●		●	●
Roof Rack									
— Black	○	○	○	○	○		○	○	○
— Body-color						●			
Seating									
— Intermediate deluxe bench with rear 3-passenger bench							●		
— Intermediate deluxe bench with 2 child seats and rear 3-passenger bench							○		
— Intermediate deluxe bench with rear deluxe 3-passenger bench	●	●						●	●
— Intermediate deluxe bench with 2 child seats and rear deluxe 3-passenger bench seat	○	○						○	○
— Intermediate Quad Command roller bucket seats and rear deluxe 3-passenger bench seat			○						○
— Intermediate Quad Command roller bucket seats with 1 child seat and rear deluxe 3-passenger bench seat			○						○
— Intermediate Quad Command roller bucket seats and rear deluxe 50/50 split bench roller seats			●	●	●				●
— Intermediate buckets and deluxe rear bench seat with center armrest						●			
— Intermediate Quad Command roller bucket seats with 1 child seat and rear deluxe 50/50 split 3-passenger bench seat			○	○					○
— Intermediate buckets with 1 child seat and deluxe rear bench seat with armrest						○			
— Front, heated (requires leather seat trim)						○			
— Power 8-way driver's seat		○	●	●	●	●		○	●
— Power 8-way passenger seat						●			
Seats — Seating surfaces							●		
— Cloth seat trim									
— Deluxe cloth seat trim	●	●	●					●	●
— Premium cloth seat trim				●					
— Deluxe leather seat trim				○	●				
— Luxury leather seat trim						●			
Security Alarm — Security alarm and Sentry Key® Engine Immobilizer		○	○	○	●	●		○	○
Smoker's Group — Front and rear ashtrays and cigar lighter	○	○	○	○	○	○	○	○	○
Sound System									
— AM/FM stereo radio with cassette player and 4 speakers							●		
— AM/FM stereo radio with cassette player and 6 speakers	●	●						●	●
— AM/FM stereo radio with CD player and 6 speakers	○	○						○	○
— AM/FM stereo radio with cassette player, CD player and 6 speakers		○	●						○
— AM/FM stereo radio with cassette player, CD player and Infinity Acoustic 10™ speaker system		○	○	○	○	●		○	○
— AM/FM stereo radio with cassette player with Infinity Acoustic 10 speakers				●	●				
— AM/FM cassette player with in-dash 4-disc CD changer and Infinity Acoustic 10 speaker system			○	○	○	○			○
— Infinity Acoustic 10 speaker system (requires cassette/CD player)		○	○	●	●	●		○	○
— Steering wheel-mounted audio controls				○	○	●			
Speed Control — Electronic with steering wheel-mounted controls (included with Deluxe Convenience Group)	●	●	●	●	●	●	P	●	●
Steering Column — Tilt (included with Deluxe Convenience Group)	●	●	●	●	●	●	P	●	●
Suspension — Load leveling and height control (requires antilock brakes) (Standard on AWD models)	○	○	○	○	○	●	○	○	○
Tires									
— 215/70R15 BSW All-Season	●	●	●				●	●	●
— 215/65R16 LBL All-Season Touring				●	●	●			
— Spare tire, full-size	○	○	○	○	○	●	○	○	○
Traction Control — Low-Speed (Not available on AWD models)				○	○	●			
Trailer Tow Group — 160-ampere alternator, 600-ampere battery, 4-wheel disc brakes with ABS, heavy-duty engine cooling, load leveling and height control suspension, full-size spare tire and trailer tow wiring harness		○	○	○	○	○			
Wheels									
— 15" steel with Orbiter wheel covers							●		
— 15" steel with Solara wheel covers								●	●
— 15" steel wheel with Solara TC wheel cover	●	●	●						
— 16" steel wheel with Chronos wheel cover				●					
— 16" Scorpion aluminum wheel		○	○	○	●				
— 16" Constellation chrome wheel						●			
Windows — Power front and rear quarter vents (included with Power Convenience Group)	●	●	●	●	●	●	P	●	●

Always use seat belts. Children 12 and under should always be in a backseat correctly using an infant or child restraint system, or a seat belt that is right for their age and size.

● = Included P = Available within package noted in parentheses ○ = Optional

If you would like to discuss vehicle details or pricing with a knowledgeable advisor before visiting your dealer, call 1-800-CHRYSLER, or visit our Web site at www.chrysler.com

TOWN & COUNTRY/VOYAGER

ALL CHRYSLER TOWN & COUNTRY'S INCLUDE:

- Air Bags*** — Next Generation multistage driver and front-passenger
- Air Conditioning**
- Air Dam** — Front
- Brake-Park Interlock** — Cannot shift out of Park unless brake pedal is depressed
- Brakes** — Four-wheel disc antilock
- Bumpers** — Front and rear, five mph
- Cargo Net** — Located between front bucket seats
- Defroster** — Electric rear window and windshield wiper de-icer
- Door Locks** — Power
- Doors** — Driver- and passenger-side rear sliding doors
- Floor Covering** — Carpets, passenger and cargo area
- Floor Mats** — Front and rear
- Fuel Tank** — 20-gallon with tethered cap
- Grocery Bag Hooks** — Rear seatbacks
- Instrument Cluster** — Tachometer
- Lighting**
 - Exterior
 - Halogen headlamps
 - Interior
 - Dual liftgate flood lamps
- Mirrors**
 - Exterior
 - Dual folding power, heated
- Power Outlets** — Instrument Panel (2), middle/rear (1), 12-volt
- Seats** — Easy Out® Roller Seats
- Scuff Pad** — Rear fascia
- Sound Insulation** — Deluxe Sound Insulation Package
- Speed Control** — Electronic with steering wheel-mounted controls
- Steering** — Power rack-and-pinion
- Steering Column** — Tilt
- Suspension** — Normal-duty
- Tires**
 - 215/70R15 BSW all-season
 - Spare tire, compact, full-size on Limited
- User-Ready Child Seat Lower Anchors and Upper Tether Strap Anchors and Lower Wire Loops (LATCH)** — Located at all intermediate and rear seat positions
- Windshield Wipers** — Front, variable intermittent
 - Rear, intermittent
- Windows** — Power front and rear quarter vents
- Windshield Wiper De-icer**



Town & Country Limited

ALL CHRYSLER VOYAGERS INCLUDE:

- Air Bags*** — Next Generation multistage driver and front-passenger
- Air Conditioning** — Manual temperature controls
- Air Dam** — Front
- Alternator** — 140-ampere
- Brake-Park Interlock** — Cannot shift out of Park unless brake pedal is depressed
- Brakes** — Power front disc/rear drum
- Bumpers** — Front and rear, five mph
- Cargo Net** — Located between front bucket seats
- Doors** — Driver and passenger side rear sliding doors
- Floor Covering** — Carpets, passenger and cargo area
- Fuel Tank** — 20-gallon with tethered cap
- Grocery Bag Hooks** — Rear seatbacks
- Lighting**
 - Exterior
 - Halogen headlamps
 - Interior
 - Front dome
 - Cargo compartment
 - Dual liftgate flood lamps
- Mirrors**
 - Exterior
 - Dual folding
- Power Outlets** — Instrument Panel (2), Middle/Rear (1), 12 volt
- Seats** — Easy Out Roller Seats
- Sound Insulation** — Rear floor silencer
- Steering** — Power rack-and-pinion
- Storage Drawer** — Under front-passenger seat, lockable
- Suspension** — Normal-duty
- Tires** — 215/70R15 BSW All-Season
 - Spare tire, compact
- User-Ready Child Seat Lower Anchors and Upper Tether Strap Anchors and Lower Wire Loops (LATCH)** — Located at all intermediate and rear seat positions
- Wheels** — 15-inch steel wheels
- Windshield Wipers** — Front, variable intermittent
 - Rear, intermittent



Voyager LX

*Certified to the Federal Regulations that allow less forceful front air bags. Always use seat belts. Children 12 and under should always be in a backseat correctly using an infant or child restraint system, or a seat belt that is right for their age and size.

MAXIMUM TRAILER WEIGHT FOR CHRYSLER MINIVANS⁽¹⁾

Travel Condition	2.4L Engines with 3-speed Automatic Transmission only	3.3L, 3.8L Engines with 4-speed Automatic Transmission	3.3L, 3.8L Engines with Heavy-Duty Trailer Tow Package	3.8L Engines with 4-speed Automatic Transmission	3.8L Engines with Heavy-Duty Trailer Tow Package
	Max. combined weight of trailer not to exceed 5,200 lb	Max. combined weight of vehicle and trailer not to exceed 6,600 lb	Max. combined weight of vehicle and trailer not to exceed 8,600 lb	Max. combined weight of vehicle and trailer not to exceed 6,000 lb	Max. combined weight of vehicle and trailer not to exceed 8,600 lb
	All Models	FWD only	FWD only	AWD	AWD
Up to 2 persons and luggage (lb)	850	1,800	3,800	1,550	3,550
3 to 5 persons and luggage (lb)	400	1,350	3,350	1,100	3,100
6 to 7 persons and luggage (lb)	0	1,000	3,000	750	2,750

⁽¹⁾Trailer frontal area not to exceed 32 square feet

Displacement	152.5 cu in	201.5 cu in	230.5 cu in
Compression Ratio	9.4:1	9.3:1	9.6:1
Bore and Stroke (in)	3.44 x 3.98	3.66 x 3.19	3.78 x 3.43
Valve System	DOHC 16-valve	OHV 12-valve	OHV 12-valve
Fuel System	Sequential Multipoint Electronic Fuel Injection		
Horsepower (SAE net @ rpm)	150 @ 5,200*	180 @ 5,200*	215 @ 5,000*
Torque (lb-ft @ rpm)	167 @ 4,000*	210 @ 4,000*	245 @ 4,000*

*When using midgrade fuel. This engine will operate safely and satisfactorily on regular unleaded fuel.

WEIGHT AND CAPACITIES

Town & Country/Voyager

Base Curb Weight (lb)	4,154/3,908
Fuel Tank (gal)	20.0/20.0
Turning Diameter — Curb-to-curb (ft)	39.4/37.6

INTERIOR DIMENSIONS

Town & Country/Voyager

Head Room	— Front	39.6/39.7
	— Rear	39.1/39.8
Leg Room	— Front	40.6/40.6
	— Rear	39.0/36.5
Shoulder Room	— Front	62.9/62.9
	— Rear	64.7/64.7
Hip Room	— Front	57.2/57.2
	— Rear	67.6/67.8

EXTERIOR DIMENSIONS

Town & Country/Voyager

Wheelbase (in)	119.3/113.3
Overall length (in)	200.5/189.1
Overall width (in)	78.6/78.6
Overall height (in)	68.8/68.9
Track (in) — Front	63.0
	— Rear

SPECIFICATIONS

Passenger interior volume (cu ft)	167.3/157.1
Cargo capacity (cu ft)	
— Behind rear seat	17.8/15.3
— Behind intermediate seat with rear seat removed	51.3/45.6
— Behind front seat with rear and intermediate seats removed	167.9/146.7



Long after a vehicle is driven away from the showroom, we will be there to ensure that our customers remain pleased with every new-vehicle purchase. To prove this commitment, all Chrysler vehicles are covered by the 3/36 Customer One Care™ Plan,* which includes a 3-year/36,000-mile (whichever comes first) Bumper-to-Bumper Limited Warranty† and Roadside Assistance‡ for 3 years or 36,000 miles. Roadside Assistance provides 24-hour, 7-day-a-week Emergency Road Service, contacted by a nationwide toll-free number. A 5-year or 100,000-mile Outer-Panel Rust-Through Limited Warranty covers the cost of all parts and labor needed to repair exterior sheet metal panels if perforated by corrosion. The 3/36 Customer One Care Plan stays with the vehicle, transferring automatically to subsequent owners at no cost during the warranty period.

*See your dealer for additional details and a copy of this limited warranty. †Covers the complete vehicle against defects in materials and workmanship. Excludes wiper blades, clutch disc, brake pads, linings, rotors and drums, normal maintenance items (these items are covered against defects for 12 months or 12,000 miles, whichever comes first) and tires (covered by their own manufacturer's warranty). ‡Roadside Assistance services are provided by Cross Country Motor Club, Inc. (In California, Cross Country Motor Club of California, Inc.)

LEASING

Leasing is a popular way to finance a new vehicle and the Gold Key Advantage® products offered by Chrysler Financial Company L.L.C. have the flexibility to fit your vehicle choice and your lifestyle. Gold Key Lease® payments are typically lower and for a shorter term than conventional financing. At lease end, you can: 1) turn the vehicle in and lease a new one; 2) buy the vehicle and keep it; 3) buy the vehicle and sell it for a possible profit. If the idea of driving the vehicle you want and paying less sounds great, ask your dealer about Gold Key Lease. Gold Key Plus® is a great alternative to leasing for customers who want low payments and pride of vehicle ownership — Gold Key Plus offers both. Decide how long the vehicle will be driven and the trade-in value is guaranteed (less excess mileage and wear and tear). Ask your dealer for complete details. Commercial Finance Options (CFO) offers several finance and lease options to small and midsize businesses, municipalities and small fleet operators. Gold Key Advantage products include a full range of automotive financing available through Chrysler Financial, providing flexible payment plans and finance products for qualified buyers. Many of these plans can be customized to fit your particular budget and make your new vehicle even more affordable. Ask your salesperson for details about any of the above plans.

Chrysler Financial Company L.L.C. programs are offered subject to availability and state and local laws.

DAIMLERCHRYSLER SERVICE CONTRACTS

Additional protection for owners is available through optional DaimlerChrysler Service Contracts. These service plans are available in a variety of time and mileage combinations to meet your driving needs. Ask your dealer for more information or call 1-800-442-2666.

Mopar, EVS II, Easy Out Roller Seats, Versa-Bin, Sentry Key and Customer One Care are trademarks of DaimlerChrysler. HomeLink is a registered trademark owned by Johnson Controls, Inc. Infinity Acoustic 10 is a trademark of Infinity Systems, Inc. Preferred Suede is a registered trademark of Milliken & Co. Ultra-Light is a trademark of Reiter Automotive.

Always use seat belts. Remember a backseat is the safest place for children.

FOR MORE INFORMATION ON PRODUCTS OR LEASING:
1-800-CHRYSLER www.chryslerfinancial.com
 or www.chrysler.com

Patriot Blue Pearl Coat 1,2,3,4,5
Interior: Taupe, Navy Blue,* Sandstone'

Bright Silver Metallic 1,2,3,4,5
Interior: Taupe, Navy Blue*

Inferno Red Tinted Pearl Coat 2,3,4,5
Interior: Taupe, Sandstone'

Shale Green Metallic 1,2,3,4,5
Interior: Taupe, Sandstone'

Steel Blue Pearl Coat 2,3,4,5
Interior: Taupe, Navy Blue

Stone White 1,2,3,4,5
Interior: Taupe, Navy Blue,* Sandstone'

Champagne Pearl Metallic 2,3,4,5
Interior: Taupe, Sandstone'

Dark Garnet Red Pearl Coat 1,2,3,4,5
Interior: Taupe, Sandstone'

Aquamarine Metallic 1,2
Interior: Taupe

Sterling Blue Satin Glow 3,4,5
Interior: Navy Blue

Sandstone Coventry Cloth 4

Navy Blue Coventry Cloth 4

COLORS & FABRICS

Navy Blue Seton Sutton Leather 4

Taupe Coventry Cloth 4

Taupe Matisse Cloth 2,3

Navy Blue Matisse Cloth 2,3

Navy Blue Seton Sutton Leather
with Preferred Suede® accents 5

Taupe Seton Sutton Leather
with Preferred Suede accents 5

Sandstone Cranbrook Cloth 1

Legend :

- 1 — Voyager
- 2 — Voyager LX
- 3 — Town & Country LX
- 4 — Town & Country LXi
- 5 — Town & Country Limited

*Navy Blue interior not available on 1.
Sandstone interior not available on 5.



A new family has moved onto the street. PT Cruiser, audaciously retro, superbly functional. 300M, purebred descendant of the fabled 300 letter series. LHS, elegance in pursuit of the extraordinary. Town & Country/Voyager, the culmination of Chrysler's invented-here minivan. Concorde, cab-forward's original design, continuously refined. And three new members of the Chrysler family. Sebring, the distinctively Chrysler sedan with a Euro racing flavor. Sebring Coupe, elegant styling, sporty stance and agility. Sebring Convertible, the next generation of America's best-selling* sun runner.



CHRYSLER

