



**ATTITUDE  
RUNS IN THE FAMILY**

# **2007 CHARGER**

After more than thirty years, HEMI® power is unleashed to the streets in the new 2007 Dodge Charger.

Check out the bold look and powerful performance of Charger

- Power and Performance
- Color Options
- Models

For more information, visit [dodge.com/charger](http://dodge.com/charger)

©1995-2006 DaimlerChrysler. All Rights Reserved. HEMI is a registered trademark of DaimlerChrysler Corporation

For important information, go to [dodge.com/universal/privacy.html](http://dodge.com/universal/privacy.html)



## POWER

Charger R/T's 5.7-liter HEMI® V8 engine with the Multiple-Displacement System (MDS) is a pure stroke of genius. By switching from eight cylinders to four during cruising and light acceleration.



Charger gives you a choice of three awe-inspiring engines: Charger SE's 2.7-liter V6, Charger SXT's high-output 3.5-liter V6, and, for the Charger R/T, a 5.7-liter HEMI® V8 with the Multiple-Displacement System (MDS). With horsepower and torque ratings that most vehicles envy, all three deliver heart-stopping acceleration.



## ALL-WHEEL DRIVE

Introducing a new spin on performance with less spin at the wheels. Charger SXT and R/T feature an available all-wheel-drive system that greatly improves traction. A front differential and transfer case added to the standard rear-wheel drive layout deliver a 38/62 percent torque split between the front and rear wheels for the performance of rear-wheel-drive handling with the security of all-wheel-drive traction.



## ALL-SPEED TRACTION

The available all-speed traction control operates both the brakes and the electronic throttle control (ETC), enhancing mobility and directional stability while preventing excessive wheel slip when accelerating on slippery surfaces.

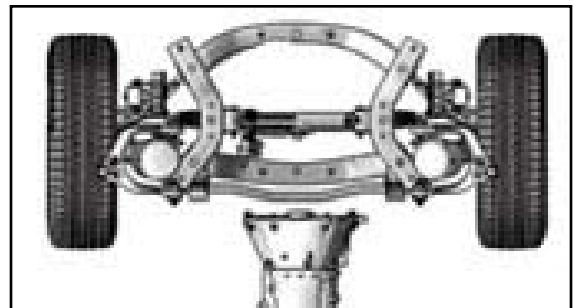

## REAR-WHEEL DRIVE

Rear-wheel drive gives better traction for acceleration with high-performance engines, a near-50/50 weight distribution enhances vehicle balance, and a longer wheelbase means a smoother ride with even more interior room.



## SUSPENSION

A short- and long-arm (SLA) front suspension and five-link independent rear suspension system maintain independent control of each wheel for excellent handling. An advanced suspension mounting system dramatically reduces road noise inside the passenger compartment. What this means to you is a smooth ride that is also quiet.

## ELECTRONIC STABILITY PROGRAM

The available electronic stability program (ESP)\* helps maintain stability by monitoring such factors as steering angle, turning rate, and lateral acceleration to determine vehicle behavior. Once the system determines that vehicle behavior differs from the driver's intended course, ESP will do whatever can be done, within the limits of available traction, to keep the car on course. The brake assist feature can detect a driver's intended panic stop, and apply optimum brake pressure to help achieve minimum stopping distances.

*\* Always drive carefully, consistent with conditions.  
Always wear your seat belt and obey traffic laws.*



**SIRIUS SATELLITE RADIO**

Available SIRIUS® satellite radio provides over 120 channels of digital-quality entertainment. Featuring 65 commercial-free channels, uninterrupted cross-country reception, and a free one-year subscription provided by SIRIUS, this is one option you really have to listen to. (Standard on R/T)

*“SIRIUS” and the SIRIUS dog logo are registered trademarks of SIRIUS Satellite Radio Inc*



**INSTRUMENT CLUSTER**

From the black-on-white gauge display in the daytime to the comfortable blue-green glow of the digits in the evening, the engaging gauges on Charger are easy to read any time of the day or night.

The available electronic vehicle information center (EVIC) is designed to provide valuable information to get you down the road. The available steering wheel—mounted controls will let you navigate through such features as the UConnect® hands-free communication system screen, the navigation system’s turn-by-turn route guidance, trip computer, outside temperature, compass, and audio settings.

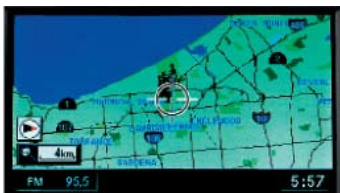

**NAVIGATION SYSTEM**

The available integrated DVD-based global positioning satellite system (GPS) with color display provides precise detail on where you are and where you’re going. In fact, it will give you turn by turn instructions so you’ll never have to stop to ask for directions.



**UCONNECT®**

The available Uconnect hands-free communication system is cool and convenient. All you need to do is set up any compatible Bluetooth® hands-free wireless phone in Charger, and the UConnect system automatically lowers the audio system volume and broadcasts the incoming call. A microphone in the rearview mirror takes your voice commands while you keep your hands on the wheel and your eyes on the road.



**VIDEO ENTERTAINMENT SYSTEM**

Because there’s only room for one driver, Charger features an available rear-seat DVD video entertainment system with 7-inch screen integrated into the center console armrest. DVD system includes two wireless headphones, remote, and auxiliary audio and video input jacks. (Not available on SE)



**PASSENGER PROTECTION**

Even the most careful driver occasionally gets into unavoidable situations. When that happens, it’s nice to know that the advanced multistage airbags front air bags standard on all models of Dodge Charger will inflate according to the severity of the impact.†

And the supplemental air bag† available on all models offer additional side-impact protection to both front- and rear-seat passengers.

*† Always wear a seat belt. Remember, a back seat is the safest place for children 12 and under.*



## FABRIC & TRIM

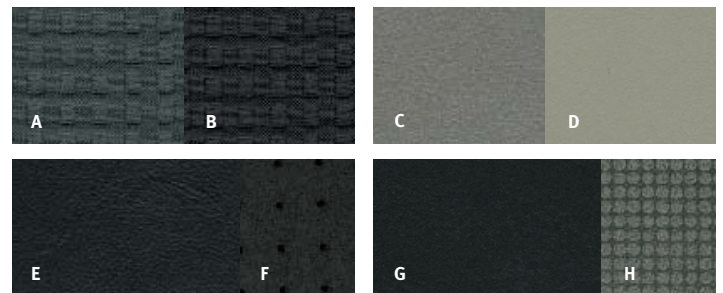
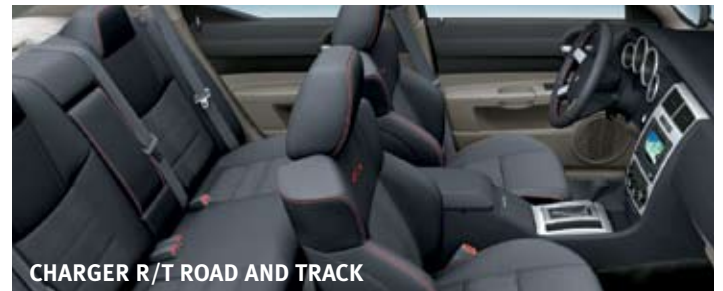

**Standard on Charger SE and SXT:** A) Ellington Cloth in Medium Slate Gray (interior shown upper left) or B) Ellington Cloth in Dark Slate Gray (interior shown upper right)

**Optional on Charger SXT and Standard on R/T:** C) Royale Leather Trim in Light Slate Gray or D) Royal Leather Trim in Light Graystone (interior shown middle left)

**Standard on Charger R/T with Road/Track Performance Group:** E) Caprice Vinyl in Dark Slate Gray (interior shown middle right) with F) with Perforated Preferred Suede® Microfiber in Dark Slate Gray

**Standard on Charger SRT8:** G) Royale Leather Trim in Dark Slate Gray (interior shown lower left) with H) Studs Pattern Embossed Suede in Medium Slate Gray

## AVAILABLE EXTERIOR COLORS



Inferno Red Crystal Pearl    Brilliant Black Crystal Pearl    Stone White    Bright Silver Metallic    Sublime



Torred    Steel Blue Metallic    Marine Blue Pearl    Silver Steel Metallic

## WHEELS



17" Wheel Cover  
Standard on SE

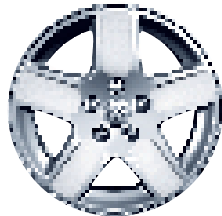

17" Machined-face Aluminum Wheel  
Standard on SXT and Optional on SE



18" Ultra-brite Aluminum Wheel  
Standard on R/T and Optional on SXT

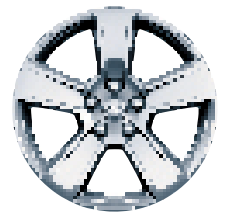

18" Chrome-clad Aluminum  
Wheel Optional on SXT and R/T



18" Machined-face Aluminum  
Wheel Standard on AWD

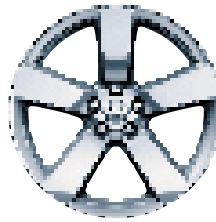

20" Chrome-clad Aluminum Wheel  
Standard on R/T with Road/Track  
Performance Group



20" SRT Forged Aluminum  
Standard on SRT8

## CHARGER BUYER'S GUIDE

	SE	SXT	R/T	R/T ROAD/TRACK	DAYTONA R/T	SRT8
	2DE	2DG	2DN	2DN	2DV	2DX
<b>ENGINE AND TRANSMISSION</b>						
2.7L DOHC 24V V6/4-SPEED AUTOMATIC	23E					
3.5L SOHC HIGH OUTPUT 24V V6/5-SPEED AUTOSTICK®	27E	27G				
5.7L MULTI-DISPLACEMENT HEMI® V8/5-SPEED AUTOSTICK			29N	29N	28V	
6.1L SRT HEMI V8/5-SPEED AUTOSTICK						21X
<b>MECHANICAL</b>						
ALL-WHEEL DRIVE		0	0			
BATTERY — 730-amp, maintenance-free	*	*	*	*	*	*
BRAKES — 4-wheel disc with vented front and solid rear discs	*					
— 4-wheel disc antilock with vented front and solid rear discs (included with 27E and ESP)	P	*				
— Performance 4-wheel disc antilock with vented front and rear discs (included with AWD models)		P	*			
— Performance Heavy-Duty 4-wheel disc antilock with vented front and rear discs				*	*	
— High-performance 4-wheel disc antilock with vented 14-inch front and 13.8-inch rear discs, includes Brembo® Performance 4-piston calipers						*
ENGINE BLOCK HEATER	0	0	0	0	0	
ENGINE COOLING — Heavy-Duty	*	*	*	*	*	
— Severe-Duty (included with AWD models)		P	P			*
FUEL TANK — 18-gallon with tethered cap	*	*				
— 19-gallon with tethered cap (included with AWD models)		P	*	*	*	*
SPEED CONTROL — Electronic with steering column-mounted controls	*	*	*	*	*	*
STEERING — Power, rack-and-pinion	*	*	*			
— Performance 9-land steering gear				*	*	
— Performance-tuned						*
SUSPENSION — Front independent short/long arm with independent 5-link rear	*	*				
— Touring independent front and rear (included with 18" wheels and AWD models)		P	*			
— Performance independent front and load leveling rear with height control				*	*	
— High-performance lowered independent front and rear						*
<b>EXTERIOR</b>						
EXHAUST SYSTEM — Stainless steel	*	*				
— Stainless steel dual exhaust with bright tips			*			
— Stainless steel performance dual exhaust with bright tips				*		
— Stainless steel high-performance dual exhaust with bright tips					*	*
HEADLAMPS — Black bezel halogen with delay	*	*	*	*	*	*
— Automatic (included with Convenience Group II, Convenience Group III, and SRT Option Group I)		P	P	*	*	P
— Fog lamps		*	*	*	*	*
MIRRORS — Power Black, fixed	*	*				
— Power body-color, folding, heated			*	*	*	*
MOLDING — Bodyside	0	*	*	*	*	*
SPOILER — Trunk lid, body-color		0		*		*
— Trunk lid, Black					*	
— Front chin				*	*	
SUNROOF — Power, with one-touch opening/closing and vent feature		0	0	0	0	0

	SE	SXT	R/T	R/T ROAD/TRACK	DAYTONA R/T	SRT8
	2DE	2DG	2DN	2DN	2DV	2DX
<b>EXTERIOR (CONTINUED)</b>						
<b>TIRES</b> — P215/65R17 all-season touring	*	*				
— P225/60R18 all-season touring (included with 18" wheels and AWD models)		P	*			
— P215/65R17 all-season touring self-sealing (included with Protection Group; not available with 23E)	P	P				
— P225/60R18 all-season touring self-sealing (included with 18" wheels, AWD models and Protection Group)		P	P			
— 245/45R20 all-season performance				*	*	
— 245/45ZR20, 255/45ZR20 performance						*
— 245/45ZR20 all-season performance						O
— Compact spare	*	*	*	*	*	
— TIREFIT System: tire sealant and electric compressor						*
<b>WHEELS</b> — 17" steel with bolt-on wheel covers	*					
— 17" aluminum, machined-face (not available with 23E)	O	*				
— 18" aluminum, ultra-brite		O	*			
— 18" aluminum, chrome-clad		O	O			
— 18" aluminum, machined-face (included with AWD models)		P	P			
— 20" aluminum, chrome-clad				*	*	
— 20" SRT forged aluminum						*
<b>WINDOWS</b> — Power with driver's one-touch auto-down	*	*	*			*
— Power with driver's and front-passenger one-touch auto-up/down, and antipinch feature (included with Convenience Group II, Convenience Group III, and SRT Option Group I)		P	P	*	*	P
<b>WINDSHIELD WIPERS</b> — 2-speed with variable intermittent mode	*	*	*	*	*	*
<b>INTERIOR</b>						
<b>AIR CONDITIONING</b> — Manual Temperature Control	*	*	*			*
— Automatic Dual-Zone Temperature Control (included with Convenience Group II, Convenience Group III, and SRT Option Group I)		P	P	*	*	P
<b>AIR FILTRATION</b> — Particulate air filter (included with Protection Group and SRT Option Group I; not available with 23E)	P	P	P	P	P	P
<b>CONSOLE</b> — Floor, with 2 cup holders, coin holder, CD and cell phone storage with 12V auxiliary power outlet, and rear-seat heat and A/C outlets	*	*	*	*	*	*
<b>DEFROSTER</b> — Rear window	*	*	*	*	*	*
<b>DOOR LOCKS</b> — Power, speed-sensitive locking, child-protection rear	*	*	*	*	*	*
<b>ELECTRONIC VEHICLE INFORMATION CENTER (EVIC)</b> — Reconfigurable driver-interactive up to 128-function information display with steering-wheel-mounted controls (included with Electronics Convenience Group)			P	P	P	*
<b>FLOOR MATS</b> — Premium carpet, front and rear (included with Convenience Group I)	O,P	*	*	*	*	*
<b>HOMELINK® UNIVERSAL TRANSCEIVER</b> — Programmable, 3-function with remote controls for garage door opener, interior/exterior home lighting or security devices (included with the Electronics Convenience Group)			P	P	P	*
<b>LIGHTING</b> — Dual front map, rear reading with theater-dimming	*	*	*	*	*	*
— Trunk lamp	*	*	*	*	*	*
<b>MIRRORS</b> — Rearview, day/night	*	*	*	*	*	*
— Rearview, auto-dimming (included with UConnect® Hands-Free Communication System and SRT Option Group III)		P	P	P	P	P
— Visor vanity, dual covered	*					
— Visor vanity, illuminated		*	*	*	*	*
<b>PEDALS</b> — Power adjustable (included with Comfort Seating Group and Convenience Group I)	P	O,P	*	*	*	*
<b>POWER ACCESSORY</b> — 12V auxiliary power outlet located in center console	*	*	*	*	*	*
— Delay feature	*	*	*	*	*	*
<b>REMOTE KEYLESS/ILLUMINATED ENTRY SYSTEM</b> — Includes 2 transmitters	*	*	*	*	*	*

	SE	SXT	R/T	R/T ROAD/TRACK	DAYTONA R/T	SRT8
	±DE	±DG	±DN	±DN	±DV	±DX
<b>INTERIOR (CONTINUED)</b>						
SHIFT KNOB — Urethane	*					
— Leather-wrapped with Satin Silver accent		*	*			
— Fully leather-wrapped with red accent stitching on SRT8 models and on Road/Track Performance Group, and body-color accent stitching on Daytona models)				*	*	*
SPEEDOMETER — 140-mph with electroluminescent display	*	*				
— 160-mph with electroluminescent display			*	*	*	
— 180-mph with electroluminescent display						*
STEERING COLUMN — Tilt/telescoping, manual	*	*	*	*	*	*
STEERING WHEEL — Urethane	*					
— Leather-wrapped		*	*	*	*	
— Leather-wrapped with carbon fiber-style upper trim accents with red accent stitching						*
— Steering wheel-mounted audio and EVIC controls (included with Electronics Convenience Group)			P	P	P	*
TEMPERATURE DISPLAY — Outside, located in instrument cluster	*	*	*	*	*	
— Outside, with compass, located in EVIC (included with Electronics Convenience Group)			P	P	P	*
<b>SEATING</b>						
FABRIC — Cloth	*	*				
— Premium leather-trim (included with Comfort Seating Group)		O,P	*			
— Premium vinyl-trim with suede microfiber inserts				*	*	
— Premium leather-trim with suede microfiber inserts						*
FRONT — Front low-back buckets with seatback map pockets	*	*	*			
— Front low-back performance buckets with seatback map pockets				*	*	*
— 8-way power driver's (included with Convenience Group I)	P	*	*			
— 8-way power driver's and front-passenger (included with Comfort Seating Group and Convenience Group II)		P	P	*	*	*
— Heated front (included with Comfort Seating Group and Convenience Group I)		P	P	*	*	P
— Manual driver's/passenger adjustable lumbar	*	*	*	*	*	*
REAR — Fixed rear bench	*					
— 60/40 split-folding rear bench with armrest and cup holders		*	*	*	*	*
<b>ENTERTAINMENT</b>						
RADIOS						
— AM/FM radio with single-disc CD player, changer controls and auxiliary audio input jack	*	*	*	*	*	*
— AM/FM radio with cassette and integrated 6-disc CD changer with MP3 capability (included with Sound Group II, and SRT Option Group II)		O	O,P	O,P	O,P	P
— AM/FM radio with integrated 6-disc CD changer with MP3 capability, integrated DVD-based GPS Navigation System with 5.8" display screen (included with SRT Option Group III)		O	O	O	O	P
SIRIUS® SATELLITE RADIO — (Included with SRT Option Group III; not available with 23E)	O	O	*	*	*	P
SOUND SYSTEMS — 4 speakers	*					
— 6 Boston Acoustics® speakers with 276-watt digital amplifier		*	*	*	*	*
— 6 Boston Acoustics speakers with 322-watt digital amplifier and subwoofer (included with Sound Group II)			P	P	P	
— 11 SRT High-Performance KICKER® speakers (7 locations) with a 276-watt digital amplifier and 200-watt subwoofer amplifier (included with SRT Option Group II)						P



	SE	SXT	R/T	R/T ROAD/TRACK	DAYTONA R/T	SRT8
	≥DE	≥DG	≥DN	≥DN	≥DV	≥DX
<b>ENTERTAINMENT (CONTINUED)</b>						
<b>VEHICLE ENTERTAINMENT SYSTEM (VES<sup>®</sup>)</b> — DVD system includes 7" screen located in center console armrest, remote control, 2 wireless headsets, and faceplate audio and video input jacks. On SRT8 model, system also includes Simulated Surround Sound and SRT High-Performance KICKER Sound System (requires AM/FM/cassette/6-disc CD or GPS Navigation System)		O	O	O	O	O
<b>SAFETY AND SECURITY</b>						
<b>AIR BAGS<sup>(1)</sup></b> — Advanced multistage for driver and front-passenger	*	*	*	*	*	*
— Supplemental side-curtain for front and rear outboard occupants (included with Protection Group)	OP	P	P	P	P	O
<b>CHILD SEAT ANCHOR SYSTEM (LATCH)</b> — Mounts for 2 child seats in the rear help ease the installation of compatible aftermarket child seats	*	*	*	*	*	*
<b>ELECTRONIC STABILITY PROGRAM<sup>(2)</sup></b> — Includes 4-wheel antilock brakes with Brake Assist and all-speed traction control (included with 27E)	OP	*	*	*	*	*
<b>SECURITY ALARM</b> — (Included with Electronics Convenience Group and SRT Option Group II)			P	P	P	P
<b>SENTRY KEY<sup>®</sup></b> — Antitheft engine immobilizer	*	*	*	*	*	*
<b>TIRE PRESSURE MONITORING DISPLAY</b> — Located in EVIC						*
<b>TIRE PRESSURE MONITORING WARNING LAMP</b>			*	*	*	
<b>UCONNECT<sup>®</sup> HANDS-FREE COMMUNICATION SYSTEM</b> — Includes auto-dimming rearview mirror (included with SRT Option Group III)		O	O	O	O	P
<b>PACKAGES</b>						
<b>COMFORT SEATING GROUP</b> — Includes leather-trimmed seats, 8-way power heated driver's and front-passenger seats, leather-wrapped steering wheel and shift knob, and power adjustable pedals		O				
<b>CONVENIENCE GROUP I</b> — Includes 8-way power driver's seat and power adjustable pedals, and premium floor mats	O					
<b>CONVENIENCE GROUP II</b> — Includes Automatic Dual Zone Temperature Control, 8-way power heated front seats, automatic headlamps, and driver's and front-passenger one-touch auto-up/down front windows			O			
<b>CONVENIENCE GROUP III</b> — Includes Automatic Dual Zone Temperature Control, automatic headlamps, driver's and front-passenger one-touch auto-up/down front windows		O				
<b>ELECTRONICS CONVENIENCE GROUP</b> — Includes Electronic Vehicle Information Center (EVIC); instrument cluster with display screen, temperature and compass gauge, traveler/mini-trip computer, security alarm, steering wheel-mounted audio controls, and HomeLink <sup>®</sup> Universal Transceiver			O	O	O	
<b>PROTECTION GROUP</b> — Includes front and rear supplemental side-curtain air bags, air filtration, and self-sealing tires (tires not available with Road/Track Performance Group and Daytona R/T; not available with 23E)	O	O	O	O	O	
<b>SMOKER'S GROUP</b> — Includes front ashtray and lighter	*	*	*	*	*	*
<b>SOUND GROUP II</b> — Includes AM/FM stereo radio with cassette and integrated 6-disc CD changer with MP3 capability and 6 Boston Acoustics speakers with 322-watt digital amplifier and subwoofer			O	O	O	
<b>SRT OPTION GROUP I</b> — Includes air filtration, Automatic Dual Zone Temperature Control, heated front seats, driver's and front-passenger one-touch auto-up/down windows, and automatic headlamps						O
<b>SRT OPTION GROUP II</b> — Includes AM/FM radio with integrated 6-disc CD changer with MP3 capability, security alarm, and 11 SRT High-Performance KICKER speakers						O
<b>SRT OPTION GROUP III</b> — Includes AM/FM radio with integrated 6-disc CD changer with MP3 capability, integrated DVD-based GPS Navigation System with 5.8" display screen, SIRIUS Satellite Radio, and auto-dimming rearview mirror with Uconnect Hands-Free Communication System						O

\* = Included. P = Available within package noted. O = Optional.

<sup>(1)</sup>Always sit properly in the seat with the seat belt fastened. Children 12 and under should always be in a backseat correctly using an infant or child restraint system, or the seat belt positioned correctly for the child's age and weight. <sup>(2)</sup>No system, no matter how sophisticated, can repeal the laws of physics or overcome careless driving actions. Performance is limited by available traction, which snow, ice and other conditions can affect. When the ESP warning lamp in the speedometer flashes, the driver needs to use less throttle and adapt speed and driving behavior to prevailing road conditions. Always drive carefully, consistent with conditions. Always wear your seat belt.