

2020

SUPER DUTY[®] CHASSIS CAB

F-350 | F-450 | F-550



BUILT FOR THE BUILDERS.

It's not how you start a job. It's how well you get it done in the trenches. And the 2020 F-Series Super Duty® Chassis Cab helps you finish the only way it knows how: strong. With 3 engine choices, including an all-new, available 7.3L V8 gas engine engineered for conditions where nasty is normal, and a significantly enhanced 3rd-generation of our available 6.7L Power Stroke® V8 Turbo Diesel. With a new 10-speed TorqShift® automatic transmission calibrated specifically for heavy-duty work. Plus, available new Ford Co-Pilot360™ driver-assist technologies¹ to help you manage the road, and FordPass Connect™² with Wi-Fi hotspot capability to help keep you – and your crew – in touch on location. As America's best-selling trucks for 42 years, Ford F-Series exists to be challenged. At Ford, we've accepted challenges for over 116 years.

Our resilience shows that we're in it for the long haul. For the pride of a job well done.

We build for the builders. And we build things our way.

BUILT *Ford* PROUD

AMERICA'S BEST **43 YEARS** FORD F-SERIES **SELLING TRUCKS**

F-450 XLT SuperCab 4x4 in Iconic Silver with available and aftermarket equipment. (Max. Payload 8,240 lbs., Max. Towing 25,800 lbs., Max. GCWR 35,000 lbs. when properly equipped with 6.7L Power Stroke diesel engine, and High-Capacity Trailer Tow Package.) Best-Selling Trucks for 43 years based on 1977-2019 CY total sales. ¹Driver-assist features are supplemental and do not replace the driver's attention, judgment and need to control the vehicle. ²FordPass Connect (optional on select vehicles), the FordPass App, and complimentary Connected Service are required for remote features (see FordPass Terms for details). Connected service and features depend on compatible AT&T network availability. Evolving technology/cellular networks/vehicle capability may limit functionality and prevent operation of connected features. Connected service excludes Wi-Fi hotspot. Don't drive distracted or while using handheld devices. Use voice controls. ³Maximum capability configuration vehicles not shown. ⁴Class 3-5 Chassis Cabs based on Ford segmentation.

NOTE: Maximum payload and towing capabilities shown throughout this brochure are for properly equipped base vehicles with required equipment and a 150-lb. driver and vary based on cargo, vehicle configuration, accessories, upfits and number of passengers. See label on door jamb for carrying capacity of a specific vehicle. Horsepower, torque, payload and towing are independent attributes and may not be achieved simultaneously. For additional information, see your Ford Dealer. Vehicles throughout this brochure may be shown with optional and aftermarket upfit equipment.

MAX. AVAILABLE GCWR
40,000 LBS.

F-550 WITH HIGH-CAPACITY TRAILER TOW PACKAGE³

MAX. AVAILABLE 5TH-WHEEL TOWING

31,600 LBS.

F-550 REGULAR CAB 4x2 60" CA WITH HIGH-CAPACITY TRAILER TOW PACKAGE³

MAX. AVAILABLE FRONT GAWR

7,500 LBS.

F-450/F-550 WITH EXTRA-HEAVY-DUTY FRONT-END SUSPENSION PACKAGE³

CLASS-BEST⁴ MAX. AVAILABLE PAYLOAD

12,750 LBS.

F-550 REGULAR CAB 4x2 84" CA WITH 7.3L GAS ENGINE AND PAYLOAD PLUS UPGRADE PACKAGE³

NEW RIGHT-SIZED

F-600

AVAILABLE SUMMER 2020



POWERFUL PULL.

Backed by decades of Built Ford Tough® commercial engine expertise, both Super Duty® Chassis Cab gas engines – a 6.2L V8 (F-350) and the all-new, available 7.3L V8 (F-350/F-450/F-550) – help you power through the tough work you face every day. For heavy-duty diesel performance, our available 3rd-generation 6.7L Power Stroke® V8 Turbo Diesel (F-350/F-450/F-550) delivers 825 lb.-ft. of work-ready torque. All 3 engines, plus the new TorqShift® 10-speed automatic transmission they're paired with, are designed, engineered and built by Ford. So each powertrain works seamlessly with chassis components and vehicle calibrations.

F-450 XL Crew Cab 4x4 in Oxford White with 7.3L gas engine, and available and aftermarket upfit equipment.

Horsepower and torque are independent attributes and may not be achieved simultaneously. For additional information, see your Ford Dealer.

MAX. TORQUE (LB.-FT.) ○
MAX. HORSEPOWER ○

3RD-GENERATION 6.7L POWER STROKE V8 TURBO DIESEL

Our proven Power Stroke diesel gets significant upgrades that push its torque output even higher. Reengineered injectors in the new 36,000-psi fuel-injection system help it optimize combustion and provide excellent throttle response. In this high-pressure environment, new forged-steel pistons provide higher firing pressure capability and less friction for improved durability. A new turbocharger with fully electronic vane actuator improves cold-weather performance. Finally, a new air-induction system and redesigned grille ensure plenty of airflow to help keep things cool. Which the 6.7L Power Stroke V8 Turbo Diesel has done for years – stay cool under pressure.

Available on F-350/F-450/F-550

NEW 7.3L 2-VALVE V8 GAS

Get ready for a new legend in the world of work. This beast debuts as the largest displacement V8 engine in the class. Built from the ground up as a dedicated truck engine, it's engineered for iron-clad durability. To enable it to work harder for longer, its stout design features: cast-iron engine block construction; a forged-steel crankshaft; carbon-nitrided needle bearings in the valvetrain; robust pistons and ring packs with anti-wear coatings; piston cooling jets; and a variable-displacement oil pump located in the pan. The pump ensures proper engine lubrication in cold weather starts and, over time, even accommodates engine-wear changes to maintain optimum engine performance. And that's what it's all about in harsh environments where these trucks may not leave for months. The all-new 7.3L V8 from Ford. Tough lives here.

*Standard on F-450/F-550
Available on F-350*

6.2L 2-VALVE V8 GAS

By supplying working power throughout the rpm range, the 6.2L V8 delivers an exceptional combination of driveability, hauling and towing performance. Dual-equal variable cam timing phases the intake- and exhaust-valve opening and closing events simultaneously to optimize low-end torque and peak horsepower.

Standard on F-350

825

330

468

350

430

385

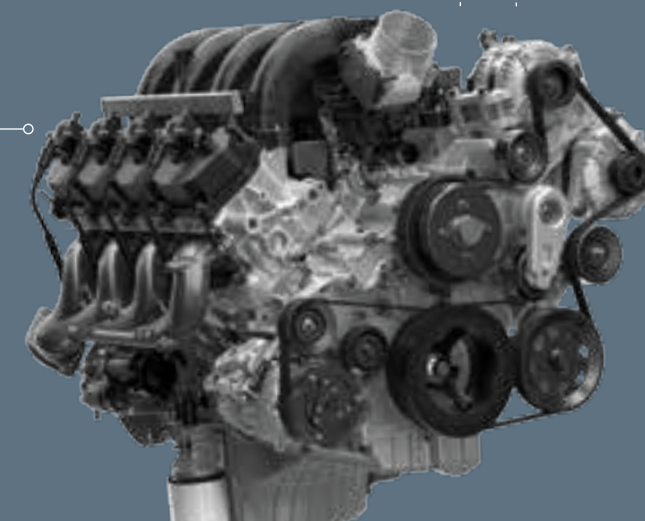

3 LEVELS OF CAPABILITY

Available	F-350	F-450	F-550
Max. 5th-Wheel Towing	24,700 lbs.	26,600 lbs.	31,600 lbs.
Max. Conventional Towing	17,500 lbs.	17,500 lbs.	18,500 lbs.
Max. Payload	7,940 lbs.	9,850 lbs.	12,750 lbs. - Class Best
Max. GVWR	14,000 lbs.	16,500 lbs.	19,500 lbs.
Max. GCWR	32,500 lbs.	35,000 lbs.	40,000 lbs.
Max. Front GAWR	5,250 lbs. (4x2) 6,000 lbs. (4x4)	7,500 lbs.	7,500 lbs.
Drivetrains	Single Rear Wheel (SRW) or Dual Rear Wheel (DRW) 4x2 or 4x4	DRW 4x2 or 4x4	DRW 4x2 or 4x4
Cab Types	Regular Cab, SuperCab, Crew Cab	Regular Cab, SuperCab, Crew Cab	Regular Cab, SuperCab, Crew Cab
Trim Levels	All	All	All

When properly configured. See Payload and Towing charts in the Specifications section for maximum ratings by configuration. Maximum capability configuration vehicles not shown.



F-450 XL Crew Cab 4x4 in Oxford White with 7.3L gas engine, and available and aftermarket upfit equipment. (Max. 5th-Wheel Towing of 19,600 lbs., Max. Conventional Towing of 17,500 lbs., Max. Payload of 9,070 lbs., Max. GVWR of 16,500 lbs., and Max. GCWR of 28,000 lbs.)*Stationary-mode PTO max. torque ratings: 300 lb.-ft. on diesel, 250 lb.-ft. on gas. Mobile-mode PTO max. torque ratings: 200 lb.-ft. on diesel, 125 lb.-ft. on 7.3L gas, and 115 lb.-ft. on 6.2L gas.

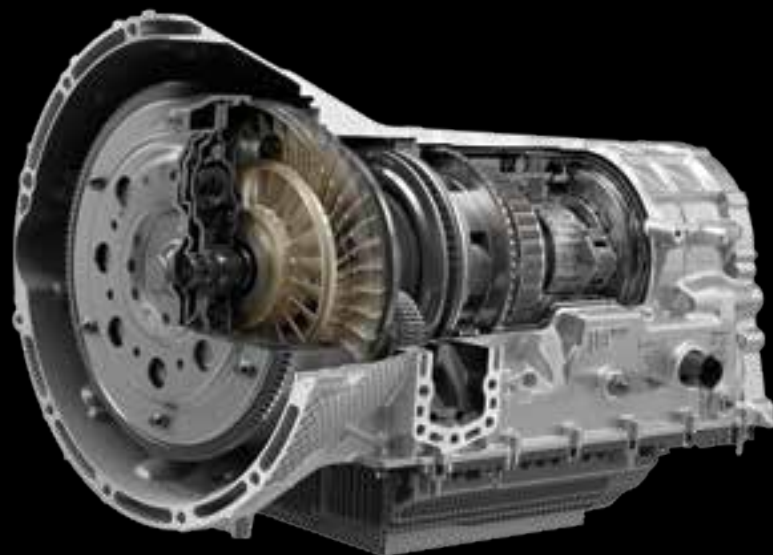

ALL-NEW TORQSHIFT® 10-SPEED AUTOMATIC TRANSMISSION

In the unforgiving landscapes where Super Duty® Chassis Cab excels, it's all about strength, capability, plus smooth and efficient power delivery. This year, operators of all 3 engines will benefit from our robust TorqShift 10-speed automatic that's engineered for durability and calibrated specifically for heavy-duty work. With a low 4.615 1st-gear ratio producing outstanding starting torque, the 10-speed also offers a wide range of overdrive gears. A state-of-the-art hydraulic control system supplies smooth, fast shifts, exceptional gear selection, and on diesel engines, a neutral idle for commercial truck use. Selectable Drive Modes allow drivers to optimize how Chassis Cab performs in a given driving condition (Slippery, Deep Snow/Sand, etc.).

Standard on ALL TRIMS

AN ENHANCED LIVE-DRIVE PTO PROVISION

Gives you more power takeoff (PTO) capability on Chassis Cab with the available diesel engine than ever before. With stationary- and mobile-mode operation,¹ the PTO provision allows Chassis Cab to power lift buckets, sprayer pumps, generators, snow plows and more. Directly linked to the engine crankshaft, the PTO output gear delivers power anytime the engine is running – whether the vehicle is moving or not. The available diesel powertrain includes split-shaft capability, which allows operation of multiple accessories at the same time when the truck is stopped. To handle the 20% increase in diesel torque output over last year, a sturdy new 10-bolt architecture helps keep your PTO securely mounted in place.

Standard with 6.7L Power Stroke V8 Turbo Diesel engine
Available with 7.3L V8 gas and 6.2L V8 gas engines



UPFITTER DREAMS START HERE.

Heavy-haulers, wreckers, and emergency vehicles rely on the unyielding strength of F-Series Super Duty® on a daily basis. As do vocational workers in construction, landscaping, mobile welding and more. With the 2020 Super Duty Chassis Cab, they can work hard. And smart. With a frame and body that carries the weight of your world on its shoulders. Available aft-of-axle frame extensions for outstanding configuration flexibility. An available, programmable Upfitter Interface Module for ease of upfitting. Six in-cab auxiliary upfitter switches to operate a variety of powered options. Plus, all of the great features listed here.

AN OPEN C-CHANNEL FRAME aft of cab features a standard 34" frame-rail width.

2

A HIGH-STRENGTH, MILITARY-GRADE, ALUMINUM ALLOY CAB¹ doesn't rust and resists corrosion. That's leadership that counts. For years down the road.

4

3-HOLE PATTERN added to the underside of the frame allows for easier aftermarket hitch installation.

1

3

RUGGED DRIVELINE COMPONENTS include a choice of strong and capable available rear axles. Ratios range from 3.73 to 4.88. Choices include non-limited-slip, available limited-slip and available electronic-locking. Gear and bearing designs are engineered and optimized by weight for the extreme capability of Super Duty Chassis Cab. Driveshafts, transfer cases and U-joints are engineered to handle the massive torque output of all 3 Super Duty engines.

AN EXTREMELY STIFF, HIGH-STRENGTH STEEL FRAME can handle a wide range of upfits, from flat and dump beds to wrecker, service and delivery bodies. Fully boxed under the cab and forward, the frame features between 7 and 10 crossmembers to enhance strength, with key crossmembers through-welded to increase stiffness.

5

6

AN AVAILABLE HEAVY-DUTY FRONT AXLE and available optimized front coil springs provide an available Front Gross Axle Weight Rating (FGAWR) of 7,500 lbs. on F-450/F-550 Chassis Cab models equipped with the available Extra-Heavy-Duty Front End Suspension Package. This enables them to carry tall utility buckets and cranes, big snow plows, and more.

7

ADVANCETRAC® WITH RSC® (ROLL STABILITY CONTROL™)² Utilizing gyroscopic sensors, AdvanceTrac with RSC enhances stability on varying road surfaces and driving conditions by selectively applying brakes and modifying engine power to help keep all wheels firmly planted.



MASSIVE BRAKES Help to bring F-450 and F-550 Super Duty Chassis Cab to a stop. A large brake pad usable area helps increase both pad and rotor life, while a large master cylinder with plenty of volume helps reduce the risk of thermal brake fade under extreme braking conditions.



AN AVAILABLE PROGRAMMABLE UPFITTER INTERFACE MODULE Allows upfitters to properly connect their electrical equipment to the Controller Area Network (CAN) test bus or ports. This connection not only allows integration of upgrades to meet upfitter needs, but gives upfitters a programmable logic interface to control devices using a laptop.

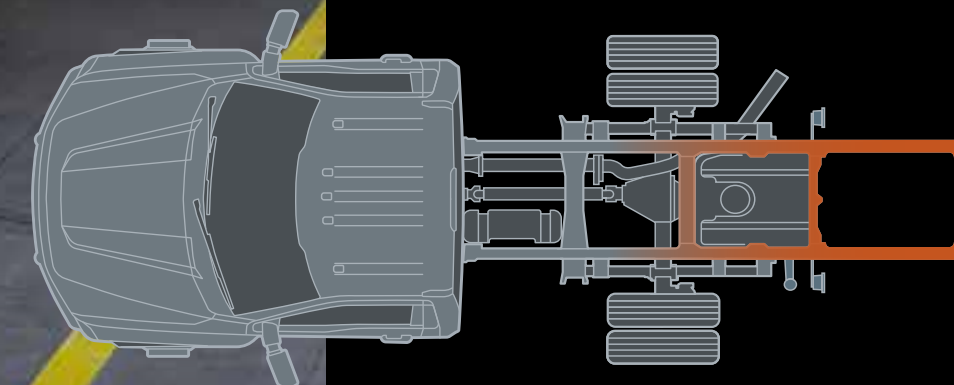

AVAILABLE AFT-OF-AXLE FRAME EXTENSIONS Provide 42" of extension with the 145" WB/60" CA and 32" of extension with the 169" WB/84" CA on F-450 and F-550 Regular Cab models - giving you outstanding configuration flexibility by allowing upfitted bodies to accommodate additional equipment.

¹6000-series aluminum alloy. ²Remember that even advanced technology cannot overcome the laws of physics. It's always possible to lose control of a vehicle due to inappropriate driver input for the conditions.

YOUR TECH, YOUR WAY.

With seating for up to 6 and Wi-Fi hotspot capability, Super Duty® Chassis Cab welcomes a vast array of smartphones, tablets and computers along for the ride. Plus, you can tap into the best in music, sports, comedy, news and talk with available SiriusXM® inside your truck and on the go, with a 6-month All Access trial subscription.¹ With our available Voice-Activated Touchscreen Navigation System, you'll also enjoy a 5-year subscription¹ to SiriusXM Traffic and Travel Link® services.

COMMAND IT

With your voice and your choice of display. Available SYNC® 3 voice-activated technology² connects your tech with your Super Duty Chassis Cab. Available SYNC 3 AppLink®³ (shown) gives you voice control of compatible mobile apps like Waze™ and Ford+Alexa.⁴ To see your phone's familiar interface on the big screen, take advantage of compatibility with Apple CarPlay®⁵ for your iPhone® or Android Auto™⁵ for your Android™ smartphone.



CONTROL IT

Monitor and control your truck in incredibly powerful ways using the FordPass™ App alone or with FordPass Alexa Skill® or FordPass Action through Google Assistant™ when equipped with FordPass Connect™⁷ Complimentary remote features let you start, lock and unlock your truck from just about anywhere, including right from your wrist with your Apple Watch®. Use your app to find your truck, schedule starts, find parking,⁸ and check fuel and fluid levels. When you need important vehicle information, like Vehicle Health Alerts, service history and Warranty info, the FordPass App puts it at your fingertips. And, when it's time to bring your truck in for service, the app makes scheduling easy. Enjoy access to convenient services like Key by Amazon In-Car Delivery⁹ and peace of mind knowing roadside assistance is just a call or e-request away.¹⁰



CONNECT IT

With available in-vehicle Wi-Fi. Before the mud dries on your work boots, you can post construction-progress videos through FordPass Connect⁷ with 4G LTE Wi-Fi hotspot capability. Its powerful antenna provides the ability to connect up to 10 devices at once¹¹ – inside of Super Duty Chassis Cab and up to 50¹ away.



Available equipment shown. ¹All SiriusXM services require a subscription, sold separately by SiriusXM after the trial period. Fees and taxes apply. See SiriusXM Customer Agreement for complete terms at www.siriusxm.com. All fees, content and features are subject to change. Traffic information not available in all markets. SiriusXM satellite service for 2020 model-year Ford vehicles is not available in Puerto Rico; SiriusXM streaming service is available for purchase. ²Don't drive while distracted. Use voice-operated systems when possible; don't use handheld devices while driving. Some features may be locked out while the vehicle is in gear. Not all features are compatible with all phones. ³Commands may vary by phone and AppLink software. ⁴Waze is available via iPhone with SYNC 3 and on Android Auto. Commands may vary by phone and AppLink software. Alexa requires available SYNC 3 AppLink. Certain Alexa functionality is dependent on smart phone and home technology. Don't drive while distracted or while using handheld devices. Use voice controls. Some features may be locked out while the vehicle is in gear. ⁵Requires device with active data service and compatible software. SYNC does not control 3rd-party products while in use. 3rd parties are solely responsible for their respective functionality. ⁶Don't drive while distracted or while

using handheld devices. Use voice controls. Certain Alexa functionality is dependent on smart phone and home technology. ⁷FordPass Connect (optional on select vehicles), the FordPass App, and complimentary Connected Service are required for remote features (see FordPass Terms for details). Connected service and features depend on compatible AT&T network availability. Evolving technology/cellular networks/vehicle capability may limit functionality and prevent operation of connected features. Connected service excludes Wi-Fi hotspot. ⁸In select cities. ⁹FordPass App, compatible with select smartphone platforms, is available via a download. FordPass Connect service required (see FordPass Terms for more information). Message and data rates may apply. Check your availability at <https://amzn.to/2JnYMit>. ¹⁰Roadside assistance is included for certain owners and available to everyone for a per-service fee. ¹¹Don't drive while distracted or while using handheld devices. Use voice controls. ¹²Driver-assist features are supplemental and do not replace the driver's attention, judgment and need to control the vehicle. ¹³Pre-Collision Assist with Automatic Emergency Braking can detect pedestrians, but not in all conditions and does not replace safe driving. See owner's manual for system limitations. ¹⁴Audible Lane-Departure Warning does not control steering.

FORD CO-PILOT360™ TECHNOLOGY READY WITH AN ASSIST.

From the work site to the highway, available new driver-assist features¹² on the 2020 Super Duty Chassis Cab are engineered to help improve driver confidence and fleet performance, plus help protect your investment in the field.



AUTO HIGH-BEAM HEADLAMPS

Sound familiar? You turn on high beams entering a dark stretch of road – then forget to turn them off as traffic approaches. Auto High-Beam Headlamps can detect poor lighting and switch them on for you. They can also sense oncoming headlamps and dim automatically for other drivers.

Available on ALL TRIMS



PRE-COLLISION ASSIST WITH AUTOMATIC EMERGENCY BRAKING

We should all drive defensively. By scanning the road ahead, this feature can alert you to potential collisions with vehicles or pedestrians detected in your path. If an impact is imminent and you don't take action, brakes can apply automatically.¹³ It's designed to only activate when needed.

Available on ALL TRIMS



AUDIBLE LANE-DEPARTURE WARNING¹⁴

When this system's forward-facing camera detects the truck crossing a lane marking without the driver using the turn signal, it provides an audible alert and a visual display in the instrument cluster.

Available on ALL TRIMS

SYNC® AppLink®

4x2 | Standard

4x4 | Available

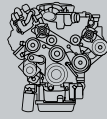

6.2L 2-VALVE GAS V8 FFV
Standard: F-350

7.3L 2-VALVE GAS V8
Standard: F-450, F-550
Available: F-350

6.7L POWER STROKE® V8
TURBO DIESEL
Available: F-350, F-450, F-550

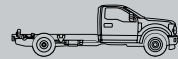

REGULAR CAB
F-350 SRW 60" CA
F-350 DRW 60" CA/84" CA
F-450 DRW
60" CA/84" CA/108" CA/120" CA
F-550 DRW
60" CA/84" CA/108" CA/120" CA

SUPERCAB
F-350 SRW 60" CA
F-350 DRW 60" CA
F-450 DRW 60" CA/84" CA
F-550 DRW 60" CA/84" CA

CREW CAB
F-350 SRW 60" CA
F-350 DRW 60" CA
F-450 DRW 60" CA/84" CA
F-550 DRW 60" CA/84" CA



40/20/40
SPLIT FRONT SEAT
Standard

40/MINI-CONSOLE/40
FRONT BUCKET SEATS
Available



THE CORNERSTONE

Featuring a black grille and front bumper, plus heavy-duty vinyl seating, XL is a no-nonsense work truck that's the bedrock of the Chassis Cab lineup. All the capability and standard features to get you comfortably through the work week are here, including your choice of 3 powerful engines and the new TorqShift® 10-speed automatic transmission.

¹Certain restrictions, 3rd-party terms and data rates may apply. See footnote 7 on the "Your Tech, Your Way" pages, and your Ford Dealer for details.



6 IN-CAB UPFITTER SWITCHES

FORDPASS CONNECT™ WITH 4G LTE WI-FI HOTSPOT CAPABILITY¹

SYNC® WITH 4.2" LCD SCREEN AND ONE SMART-CHARGING USB PORT

MANUALLY TELESCOPING TRAILER TOW MIRRORS

AUTOLAMP AUTOMATIC ON/OFF HEADLAMPS WITH RAINLAMP



40/20/40 split front seat.
Dark Earth Gray cloth-trimmed seating.
Available equipment.

Instrument panel.
Dark Earth Gray cloth-trimmed seating.
Available equipment.

F-550 Regular Cab 4x4.
Agate Black. Available and
aftermarket upfit equipment.

XL

STANDARD FEATURES:

MECHANICAL

7-wire trailer tow wiring harness with relays, blunt cut and labeled

40-gallon aft-of-axle fuel tank

650-CCA, 72-amp-hr single battery (6.2L gas)

750-CCA, 78-amp-hr single battery (7.3L gas)

750-CCA, 78-amp-hr dual batteries (diesel)

Electronic shift-on-the-fly (ESOF) transfer case (4x4)

Front and rear stabilizer bars

Front axle – Narrow-track (F-350)

Front axle – Wide-track (F-450/F-550)

Front suspension – Twin-coil monobeam with stabilizer bar (F-350 4x4/F-450/F-550)

Front suspension – Twin-I-Beam coil spring with stabilizer bar (F-350 4x2)

Heavy-duty gas shock absorbers

Hydraulic power-assisted steering

Intelligent Oil-Life Monitor® (diesel engine)

Leaf-spring rear suspension with auxiliary springs

Manual locking hubs (4x4)

Oil-life minder (gas engine)

Power 4-wheel disc brakes with Anti-Lock Brake System (ABS)

Power takeoff (PTO) provision with live-drive mobile and stationary modes, and split-shaft capability (diesel engine; PTO port located on driver's side; max. torque output of 300 lb.-ft. in stationary mode)

Stationary Elevated Idle Control (SEIC)¹

Steering damper

Tires – LT245/75Rx17E BSW all-season (F-350 DRW)

Tires – LT275/65Rx18E BSW all-season (F-350 SRW)

Tires – 225/70Rx19.5G BSW all-position (F-450/F-550)

TorqShift® 10-speed SelectShift® automatic transmission with Selectable Drive Modes

FORD CO-PILOT360™ TECHNOLOGY

Autolamp Automatic On/Off Headlamps with Rainlamp

Hill Start Assist

SOS Post-Crash Alert System™

Trailer Sway Control

SEATING

40/20/40 split front seat with 2-way manual seat adjust, driver's side manual lumbar, and folding armrest with cupholders and storage

60/40 split flip-up rear seat

Heavy-duty vinyl-trimmed seating

INTERIOR

2.3" LCD productivity screen in instrument cluster

12V powerpoints (2)

Dome light and dual map lights

Driver and front-passenger grab handles, and rear-passenger on Crew Cab

Dual glove boxes

Fixed rear window

Flooring – Black vinyl

Manual-tilt/-telescoping steering column

Outside temperature display

Overhead console with dual storage bins (SuperCab/Crew Cab)

Single-zone manual climate control

Upfitter switches located in overhead console (four 25-amp and two 40-amp; 40-amp are hot-at-all-times capable)

EXTERIOR

Black mirror caps and door handles

Black-painted grille and steel front bumper

Configurable daytime running lamps

Front splash guards (F-450/F-550)

Front tow hooks

LED roof marker/clearance lamps

Manually telescoping trailer tow mirrors with 2-way fold, and manual glass

Quad-beam jewel-effect halogen headlamps

Underhood service lamp

Variable-intermittent windshield wipers with washers

CONNECTIVITY & ENTERTAINMENT

AM/FM stereo with MP3 capability

FordPass Connect™² with 4G LTE Wi-Fi hotspot capability (enables FordPass™ app³ features when activated; includes Ford Telematics™ and Data Services Prep for Fleet only)

SYNC® Voice Recognition Communications and Entertainment System with 4.2" LCD screen, 911 Assist®, AppLink®, and 1 smart-charging USB port

SAFETY & SECURITY

Driver and right-front-passenger front airbags,⁴ and front-seat side airbags⁴

Front-passenger airbag deactivation switch

AdvanceTrac® with RSC® (Roll Stability Control™)

Safety Canopy® System with side-curtain airbags⁴ and rollover sensor

Child-safety-seat top tether anchors (Regular Cab front passenger, and all rear-seat positions)

Individual Tire Pressure Monitoring System (F-350; excludes optional spare)

AVAILABLE FEATURES AND PACKAGES:

MECHANICAL

750-CCA, 78-amp-hr dual batteries⁵ (gas engines)

Aft-of-axle frame extension⁵ (F-450/F-550 Regular Cab 145" and 169" wheelbases)

Engine block heater

Engine idle shutdown (5-, 10-, 15- or 20-minute)

Fuel tank – 26.5-gallon mid-ship⁵ (replaces standard tank)

Fuel tanks – Dual diesel with 40-gallon aft-of-axle and 26.5-gallon mid-ship (DRW diesel engine)

Individual Tire Pressure Monitoring System delete (F-350 SRW; Fleet only)

Jack (2-ton mechanical for SRW; 4-ton hydraulic for F-350 DRW; 6-ton hydraulic for F-450/F-550)

Operator-commanded exhaust filter regeneration with active regeneration inhibit (diesel engine)

Power takeoff (PTO) provision with live-drive mobile and stationary modes⁵ (gas engines; PTO port located on driver's side; max. torque output of 250 lb.-ft. in stationary mode)

Programmable Upfitter Interface Module

Spare wheel, tire and jack (excludes carrier)

Speed limitation (65-mph or 75-mph governed top speed; Fleet only)

Tires – LT245/75Rx17E BSW all-season⁵ (F-350 SRW)

Tires – LT245/75Rx17E BSW all-terrain⁵ (F-350)

Tires – LT265/70Rx17E OWL all-terrain⁵ (F-350 SRW)

Tires – LT275/70Rx18E BSW all-terrain (F-350 SRW 4x4)

Tires – 225/70Rx19.5G BSW traction (F-450/F-550; includes 2 all-position tires on front and 4 traction tires on rear)

Tires – 225/70Rx19.5G BSW max. traction (F-450/F-550 4x4; includes 2 traction tires on front and 4 traction tires on rear)

Trailer brake controller with Smart Trailer Tow Connector⁵

FORD CO-PILOT360 TECHNOLOGY

Audible Lane Departure Warning⁵

Pre-Collision Assist with Automatic Emergency Braking, Forward Collision Warning, and Auto High-Beam Headlamps⁵

SEATING

Cloth-trimmed seating

Front bucket seats with mini-console and driver's side manual lumbar

INTERIOR

SiriusXM® with 6-month All Access trial subscription⁶

110V/400W AC power outlet in instrument panel⁵

Cruise control (Fleet only)

Power-sliding rear window with defroster and rear privacy glass⁵ (SuperCab/Crew Cab)

Rapid-heat supplemental cab heater (diesel engine)

Rear-window defroster and rear privacy glass

EXTERIOR

Black molded hood deflector

Black platform running boards

Center high-mounted stop lamp (CHMSL)⁵

Chrome grille⁵ (Fleet only)

Exterior backup alarm⁷

Front splash guards (F-350)

Front wheel-well liners

Halogen fog lamps⁵

LED sideview mirror spotlights⁵

LED warning strobes⁷

Non-configurable daytime running lamps (replaces standard configurable daytime running lamps; Fleet only)

Rear View Camera and prep kit (includes pre-installed body and frame wiring, loose camera with mounting bracket, and 14' jumper wire)

Remote Start System⁵

Transfer case skid plate (4x4)

PACKAGES

Power Equipment Group: accessory delay for power features; trailer tow mirrors with 2-way fold, power/heated glass, heated manual spotter mirrors, and integrated clearance lamps and turn signal indicators; perimeter alarm; Advanced Security Pack with inclination/intrusion sensors; power locks; power windows; MyKey®; and Remote Keyless Entry System with 2 integrated keyhead transmitter remotes

Trailer Tow Package:⁵ aftermarket trailer brake wiring kit (trailer brake controller not included)

XL Decor Group (Fleet only): bright center cap on wheels (SRW only), and chrome bumper

XL Value Package: bright center caps on wheels (SRW only), chrome bumper, and cruise control

Capability Packages: content can be found opposite the LARIAT AVAILABLE FEATURES AND PACKAGES

SRW



18" Argent-Painted Steel with Painted Center Cap Standard



17" Argent-Painted Steel with Painted Center Cap⁵ Available

DRW



17" Argent-Painted Steel without Center Cap Standard: F-350



17" Stainless Steel Covers, Front and Rear⁵ Available: F-350



17" Polished Forged-Aluminum with Bright Center Cap⁸ Available: F-350



19.5" Argent-Painted Steel without Center Cap Standard: F-450, F-550



19.5" Stainless Steel Covers, Front and Rear⁵ Available: F-450, F-550

MEDIUM EARTH GRAY VINYL Standard

DARK EARTH GRAY CLOTH Available

OXFORD WHITE

ICONIC SILVER⁹

RACE RED

STONE GRAY⁹

MAGNETIC⁹

BLUE JEANS⁹

AGATE BLACK⁹

¹Final-stage manufacturer must supply control switches. ²Certain restrictions, 3rd-party terms and data rates may apply. See footnote 7 on the "Your Tech, Your Way" pages, and your Ford Dealer for details. ³FordPass smartphone app, for use with FordPass Connect, is available via download and compatible with select smartphone platforms. FordPass is on the App Store® and Google Play.™ Learn more at www.fordpass.com. Message and data rates may apply. ⁴Always wear your safety belt and follow airbag warning label instructions. ⁵Restrictions may apply. See your dealer for details. ⁶Certain restrictions, 3rd-party terms and data rates may apply. See footnote 1 on the "Your Tech, Your Way" pages, and your Ford Dealer for details. ⁷Ford Licensed Accessory. ⁸Inner rear wheels are steel. ⁹Metallic.

4x2 | Standard

4x4 | Available

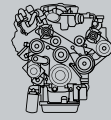

6.2L 2-VALVE GAS V8 FFV
Standard: F-350

7.3L 2-VALVE GAS V8
Standard: F-450, F-550
Available: F-350

6.7L POWER STROKE® V8
TURBO DIESEL
Available: F-350, F-450, F-550

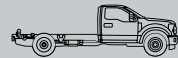

REGULAR CAB
F-350 SRW 60" CA
F-350 DRW 60" CA/84" CA
F-450 DRW
60" CA/84" CA/108" CA/120" CA
F-550 DRW
60" CA/84" CA/108" CA/120" CA

SUPERCAB
F-350 SRW 60" CA
F-350 DRW 60" CA
F-450 DRW 60" CA/84" CA
F-550 DRW 60" CA/84" CA

CREW CAB
F-350 SRW 60" CA
F-350 DRW 60" CA
F-450 DRW 60" CA/84" CA
F-550 DRW 60" CA/84" CA

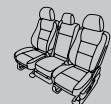

40/20/40
SPLIT FRONT SEAT
Standard

40/CONSOLE/40
FRONT BUCKET SEATS
Available



THE UTILITY PLAYER

XLT includes great XL equipment, plus the right level of refinement from its substantial list of standard features: chrome grille and front bumper; cloth seating and carpeted flooring; power windows and door locks; SYNC® 3, and SiriusXM®. An incredibly versatile member of the Chassis Cab lineup, XLT does just about everything well.



MYKEY® TECHNOLOGY

POWER DOOR LOCKS AND WINDOWS

REMOTE KEYLESS ENTRY SYSTEM

SYNC 3 WITH 8" TOUCHSCREEN AND 2 SMART-CHARGING USB PORTS

TRAILER BRAKE CONTROLLER



Available 40/console/40 front bucket seats. Medium Earth Gray cloth-trimmed seating. Available equipment.

Instrument panel. Medium Earth Gray cloth-trimmed seating. Available equipment.

F-450 SuperCab 4x4. Iconic Silver. Available and aftermarket upfit equipment.

XLT

INCLUDES SELECT XL FEATURES, PLUS:

MECHANICAL

750-CCA, 78-amp-hr single battery (6.2L gas)

Trailer brake controller with Smart Trailer Tow Connector

SEATING

40/20/40 split front seat, center under-seat lockable storage with 12V powerpoint, and folding armrest with cupholders and storage

Cloth-trimmed seating

Rear under-seat fold-flat storage, lockable and partitionable (Crew Cab)

Rear under-seat storage (SuperCab)

INTERIOR

4.2" LCD productivity screen in instrument cluster

110V/400W AC power outlet on instrument panel (also on the back of the flow-through center console, if equipped)

Accessory delay for power features

Cruise control

Flooring – Carpet with carpeted floor mats

Power door locks

Power windows with front one-touch-up/-down feature

EXTERIOR

Chrome grille and front bumper

Manually telescoping trailer tow mirrors with 2-way fold, power/heated glass, heated manual spotter mirrors, and integrated clearance lamps and turn signal indicators

Rear privacy glass

Remote Keyless Entry System with 2 integrated keyhead transmitter remotes

CONNECTIVITY & ENTERTAINMENT

SiriusXM® with 6-month All Access trial subscription¹

SYNC® 3 with 8" LCD capacitive touchscreen in center stack, 911 Assist,® AppLink,® Apple CarPlay® compatibility, Android Auto™ compatibility, and 2 smart-charging USB ports

SAFETY & SECURITY

Advanced Security Pack with inclination/intrusion sensors

MyKey® technology to help encourage responsible driving

SecuriLock® Passive Anti-Theft System

AVAILABLE FEATURES AND PACKAGES:

MECHANICAL

750-CCA, 78-amp-hr dual batteries (gas engines)

Aft-of-axle frame extension² (F-450/F-550 Regular Cab 145" and 169" wheelbases)

Engine block heater

Engine idle shutdown (5-, 10-, 15- or 20-minute)

Fuel tank – 26.5-gallon mid-ship² (replaces standard tank)

Fuel tanks – Dual diesel with 40-gallon aft-of-axle and 26.5-gallon mid-ship (DRW diesel engine)

Individual Tire Pressure Monitoring System delete (F-350 SRW; Fleet only)

Jack (2-ton mechanical for SRW; 4-ton hydraulic for F-350 DRW; 6-ton hydraulic for F-450/F-550)

Operator-commanded exhaust filter regeneration with active regeneration inhibit (diesel engine)

Power takeoff (PTO) provision with live-drive mobile and stationary modes² (gas engines; PTO port located on driver's side; max. torque output of 250 lb.-ft. in stationary mode)

Programmable Upfitter Interface Module

Spare wheel, tire and jack (excludes carrier)

Speed limitation (65-mph or 75-mph governed top speed; Fleet only)

Tires – LT245/75Rx17E BSW all-season² (F-350 SRW)

Tires – LT245/75Rx17E BSW all-terrain² (F-350)

Tires – LT245/75Rx17E OWL all-terrain (F-350 DRW)

Tires – LT265/70Rx17E OWL all-terrain² (F-350 SRW)

Tires – LT275/70Rx18E BSW all-terrain (F-350 SRW 4x4)

Tires – LT275/70Rx18E OWL all-terrain (F-350 SRW 4x4)

Tires – 225/70Rx19.5G BSW traction (F-450/F-550; includes 2 all-position tires on front and 4 traction tires on rear)

Tires – 225/70Rx19.5G BSW max. traction (F-450/F-550 4x4; includes 2 traction tires on front and 4 traction tires on rear)

FORD CO-PILOT360™ TECHNOLOGY

Audible Lane Departure Warning²

Pre-Collision Assist with Automatic Emergency Braking, Forward Collision Warning, and Auto High-Beam Headlamps²

Voice-Activated Touchscreen Navigation System with HD Radio™ Technology, and integrated SiriusXM Traffic and Travel Link® with 5-year subscription¹

SEATING

Front bucket seats and flow-through center console with lockable storage and 2 rear-facing powerpoints (SuperCab/Crew Cab)

Heated driver seat² (SuperCab/Crew Cab)

INTERIOR

Flooring – Black vinyl/carpet delete

Flooring – Floor liners (SuperCab/Crew Cab)

Power-adjustable pedals (Fleet only)

Power-sliding rear window with defroster (SuperCab/Crew Cab)

Rapid-heat supplemental cab heater (diesel engine)

Rear-window defroster

Vehicle Safe^{2,3}

EXTERIOR

Black molded hood deflector

Black platform running boards

Center high-mounted stop lamp (CHMSL)²

Exterior backup alarm³

Front splash guards (F-350)

Front wheel-well liners

Halogen fog lamps

LED sideview mirror spotlights²

LED warning strobes³

Non-configurable daytime running lamps (replaces standard configurable daytime running lamps; Fleet only)

PowerScope® power-telescoping/-folding trailer tow mirrors with power/heated glass, heated manual spotter mirrors, integrated clearance lamps and turn signal indicators, high-intensity LED security approach lamps and LED sideview mirror spotlights

Rear View Camera and prep kit (includes pre-installed body and frame wiring, loose camera with mounting bracket, and 14' jumper wire)

Remote Start System

Transfer case skid plate (4x4)

Windshield wiper de-icer²

PACKAGES

XLT Value Package: SecuriCode™ keyless entry keypad, power-adjustable pedals (SuperCab/Crew Cab), and 8-way power driver's seat (SuperCab/Crew Cab)

Capability Packages: content can be found opposite the LARIAT AVAILABLE FEATURES AND PACKAGES

SRW



18" Cast-Aluminum with Bright Center Cap Standard



17" Argent-Painted Steel with Painted Center Cap² Available

DRW



17" Argent-Painted Steel without Center Cap Standard: F-350



17" Stainless Steel Covers, Front and Rear² Available: F-350



17" Polished Forged-Aluminum with Bright Center Cap⁴ Available: F-350



19.5" Argent-Painted Steel without Center Cap Standard: F-450, F-550



19.5" Stainless Steel Covers, Front and Rear² Available: F-450, F-550



19.5" Polished Forged-Aluminum with Bright Center Cap⁴ Available: F-450, F-550

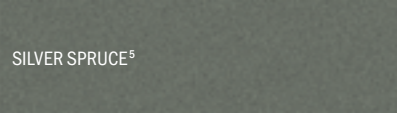
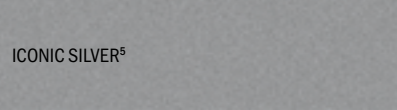
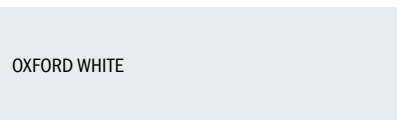
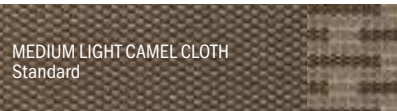

¹Certain restrictions, 3rd-party terms and data rates may apply. See footnote 1 on the “YourTech, Your Way” pages, and your Ford Dealer for details. ²Restrictions may apply. See your dealer for details.

³Ford Licensed Accessory. ⁴Inner rear wheels are steel. ⁵Metallc. ⁶Additional charge.

4x2 | Standard

4x4 | Available

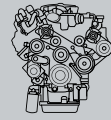

6.2L 2-VALVE GAS V8 FFV
Standard: F-350

7.3L 2-VALVE GAS V8
Standard: F-450, F-550
Available: F-350

6.7L POWER STROKE® V8
TURBO DIESEL
Available: F-350, F-450, F-550

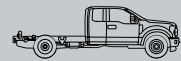

SUPERCAB

F-350 SRW 60" CA
F-350 DRW 60" CA
F-450 DRW 60" CA/84" CA
F-550 DRW 60" CA/84" CA

CREW CAB

F-350 SRW 60" CA
F-350 DRW 60" CA
F-450 DRW 60" CA/84" CA
F-550 DRW 60" CA/84" CA



40/CONSOLE/40
FRONT BUCKET SEATS
Standard

40/20/40
SPLIT FRONT SEAT
Available



CAPABLE COMFORT

You're always ready to tackle the day in LARIAT. Leather-trimmed, 10-way power-adjustable front bucket seats and power-adjustable pedals help drivers of all sizes feel at home. An 8" LCD productivity screen puts vital vehicle information front and center, while the remarkable 10-speaker B&O Sound System handles the tunes.



DUAL-ZONE ELECTRONIC AUTOMATIC TEMPERATURE CONTROL

8" LCD PRODUCTIVITY SCREEN IN INSTRUMENT CLUSTER

110V/400W AC POWER OUTLETS

POWERSCOPE® TRAILER TOW MIRRORS

SECURICODE™ KEYLESS-ENTRY KEYPAD



40/console/40 front bucket seats. Medium Light Camel leather-trimmed seating. Available equipment.

Instrument panel. Black leather-trimmed seating. Available equipment.

F-550 Crew Cab 4x4. Oxford White. Available and aftermarket upfit equipment.

LARIAT

LARIAT

INCLUDES SELECT XLT FEATURES, PLUS:

SEATING

Front bucket seats and flow-through center console with lockable storage and 2 rear-facing powerpoints

Leather-trimmed front seating

10-way power front seats

Fold-down rear-seat center armrest with dual integrated cupholders (Crew Cab)

Premium vinyl (SuperCab) or leather-trimmed (Crew Cab) rear seating

INTERIOR

8" LCD productivity screen in instrument cluster

110V/400W AC power outlets (one on instrument panel, one on back of flow-through console)

Auto-dimming rearview mirror

Dual-zone electronic automatic temperature control

Leather-wrapped steering wheel

Power-adjustable pedals

Power-sliding rear window with defroster

EXTERIOR

Body-color mirror caps and door handles

Chrome grille with chrome accents

Halogen fog lamps

PowerScope® power-telescoping/-folding trailer tow mirrors with high-intensity LED security approach lamps and LED sideview mirror spotlights

SecuriCode™ keyless entry keypad

CONNECTIVITY & ENTERTAINMENT

B&O Sound System with MP3 capability, and 10 speakers including subwoofer

AVAILABLE FEATURES AND PACKAGES:

MECHANICAL

750-CCA, 78-amp-hr dual batteries (6.2L gas)

Engine block heater

Fuel tank – 26.5-gallon mid-ship¹ (replaces standard tank)

Individual Tire Pressure Monitoring System delete (F-350 SRW; Fleet only)

Jack (2-ton mechanical for SRW; 4-ton hydraulic for F-350 DRW; 6-ton hydraulic for F-450/F-550)

Power takeoff (PTO) provision with live-drive mobile and stationary modes¹ (gas engines; PTO port located on driver's side; max. torque output of 250 lb.-ft. in stationary mode)

Programmable Upfitter Interface Module

Spare wheel, tire and jack (excludes carrier)

Tires – LT245/75R17E BSW all-terrain (F-350 DRW)

Tires – LT245/75R17E OWL all-terrain (F-350 DRW)

Tires – LT275/70R18E BSW all-terrain (F-350 SRW 4x4)

Tires – LT275/70R18E OWL all-terrain (F-350 SRW 4x4)

Tires – 225/70R19.5G BSW traction (F-450/F-550; includes 2 all-position tires on front and 4 traction tires on rear)

Tires – 225/70R19.5G BSW max. traction (F-450/F-550 4x4; includes 2 traction tires on front and 4 traction tires on rear)

FORD CO-PILOT360™ TECHNOLOGY

Audible Lane Departure Warning¹

Pre-Collision Assist with Automatic Emergency Braking, Forward Collision Warning, and Auto High-Beam Headlamps¹

Rain-Sensing Windshield Wipers¹

Voice-Activated Touchscreen Navigation System with HD Radio™ Technology, and integrated SiriusXM Traffic and Travel Link® with 5-year subscription²

SEATING

40/20/40 split front seat, center under-seat lockable storage with 12V powerpoint, and folding armrest with cupholders and storage

Heated rear outboard seats¹ (Crew Cab)

INTERIOR

Flooring – Black vinyl/carpet delete

Flooring – Floor liners

Rapid-heat supplemental cab heater¹ (diesel engine)

Vehicle Safe^{1,2}

EXTERIOR

Black molded hood deflector

Black platform running boards

Center high-mounted stop lamp (CHMSL)¹

Exterior backup alarm²

Front splash guards (F-350)

Front wheel-well liners

LED warning strobes²

Rear View Camera and prep kit (includes pre-installed body and frame wiring, loose camera with mounting bracket, and 14' jumper wire)

Remote Start System

Transfer case skid plate (4x4)

Windshield wiper de-icer¹

PACKAGES

LARIAT Value Package: memory feature for sideview mirrors; Remote Start System; heated and ventilated front seats; easy-entry/-exit driver's seat with memory; and power-adjustable pedals with memory

Capability Packages: content can be found in far-right column

SRW



18" Bright-Machined Cast-Aluminum with Bright Center Cap Standard

DRW



17" Polished Forged-Aluminum with Bright Center Cap³ Standard: F-350



19.5" Polished Forged-Aluminum with Bright Center Cap³ Standard: F-450, F-550

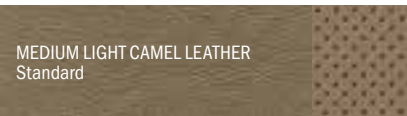

BLACK LEATHER Standard

STAR WHITE METALLIC TINTED CLEARCOAT⁴

OXFORD WHITE

ICONIC SILVER⁵

RACE RED

RAPID RED METALLIC TINTED CLEARCOAT⁴

VELOCITY BLUE⁵

SILVER SPRUCE⁵

STONE GRAY⁵

MAGNETIC^{5,6}

BLUE JEANS⁵

AGATE BLACK⁵

CAPABILITY PACKAGES

6.2L CNG/PROPANE GASEOUS ENGINE PREP PACKAGE (F-350; late availability): hardened engine intake valves and valve seats, and bi-fuel manifold
Available on ALL TRIMS

7.3L CNG/PROPANE GASEOUS ENGINE PREP PACKAGE (F-450/F-550): hardened engine intake valves and valve seats
Available on XL, XLT

16,000-LB. GVWR PACKAGE (F-450)
Available on ALL TRIMS

AMBULANCE PREP PACKAGE¹ (Fleet only): 397-amp alternator, 7,000-lb. max. front springs/GAWR rating for configuration selected, operator-commanded exhaust filter regeneration (diesel engine), and wide-track axle (F-350 DRW)
Available on XL, XLT

AMBULANCE PREP PACKAGE WITH EPA SPECIAL EMISSIONS¹ (Fleet only; requires diesel engine): 397-amp alternator, 7,000-lb. max. front springs/GAWR rating for configuration selected, operator-commanded exhaust filter regeneration, wide-track axle (F-350 DRW), and federal emissions
Available on XL, XLT

EXTRA-HEAVY-DUTY FRONT-END SUSPENSION PACKAGE¹ (F-450/F-550): upgraded front axle and 7,500-lb. front springs/GAWR rating
Available on ALL TRIMS

EXTRA-HEAVY-SERVICE FRONT SUSPENSION PACKAGE:¹ front springs upgrade⁷ (unless maximum springs have been computer-selected as included equipment)
Available on ALL TRIMS

FIRE/RESCUE PREP PACKAGE WITH EPA SPECIAL EMISSIONS¹ (Fleet only; requires diesel engine): 397-amp alternator, 7,000-lb. max. front springs/GAWR rating for configuration selected, operator-commanded exhaust filter regeneration, and federal emissions
Available on XL, XLT

HEAVY-SERVICE FRONT SUSPENSION PACKAGE:¹ front springs upgrade⁷ (unless maximum springs have been computer-selected as included equipment)
Available on ALL TRIMS

HIGH-CAPACITY TRAILER TOW PACKAGE¹ (F-450/F-550 diesel engine): trailer brake wiring kit, upgraded rear axle, and GCWR of 35,000 lbs. on F-450 and 40,000 lbs. on F-550
Available on ALL TRIMS

LOW DEFLECTION PACKAGE:¹ (F-450/F-550): 2" spacer blocks (recommended for rear-biased loading)
Available on ALL TRIMS

PAYLOAD DOWNGRADE PACKAGE:¹ 9,800-lb. GVWR and 26.5-gallon mid-ship fuel tank on F-350 SRW with 17" wheels; 10,000-lb. GVWR and 26.5-gallon mid-ship fuel tank on F-350 SRW with 18" wheels; 15,000-lb. GVWR on F-450; and 17,500-lb. GVWR on F-550
Available on ALL TRIMS

PAYLOAD PLUS UPGRADE PACKAGE¹ (F-550 with 4.88 rear axle): upgraded frame, upgraded rear axle, low-deflection/high-capacity rear springs, 14,706-lb. max. rear GAWR, and 19,500-lb. GVWR
Available on ALL TRIMS

PAYLOAD UPGRADE PACKAGE¹ (F-550 60" CA 7.3L gas engine): upgraded frame, upgraded rear axle, and 19,000-lb. GVWR
Available on XL, XLT

SNOW PLOW PREP PACKAGE:¹ computer-selected front springs for snow plow application⁷
Available on ALL TRIMS

WRECKER PACKAGE¹ (F-450 Regular Cab 60" CA): 7,000-lb. max. front springs, 19,500-lb. max. rear springs, 2" rear spacer blocks (4x2)
Available on XL, XLT

¹Restrictions may apply. See your dealer for details. ²Ford Licensed Accessory. ³Inner rear wheels are steel. ⁴Additional charge. ⁵Metallc. ⁶Not available with Medium Light Camel Leather.

⁷See dealer for springs/Front GAWR of specific vehicle configurations.

5TH-WHEEL / GOOSENECK TOWING

Maximum Loaded Trailer Weight Ratings (lbs.)¹

Engine	Axle Ratio	GCWR	F-350 SRW 4x2	F-350 SRW 4x4	F-350 DRW 4x2	F-350 DRW 4x4	F-450 DRW 4x2	F-450 DRW 4x4	F-550 DRW 4x2	F-550 DRW 4x4
REGULAR CAB										
6.2L 2-valve Gas V8 FFV	3.73	19,500	13,100	12,700	—	—	—	—	—	—
	—	20,000	—	—	13,000	12,600	—	—	—	—
	4.30	23,000	16,600	16,200	—	—	—	—	—	—
—	23,500	—	—	16,500	16,100	—	—	—	—	—
7.3L 2-valve Gas V8	3.73	22,500	—	—	15,500	15,100	—	—	—	—
	4.30	26,000	19,600	19,200	19,000	18,600	—	—	—	—
	4.88	28,000	—	—	—	—	20,400	20,100	20,400	20,100
6.7L Diesel V8	3.73	30,000	22,700	22,200	—	—	—	—	—	—
	—	31,500	—	—	23,700	23,300	—	—	—	—
	4.10	32,500	—	—	24,700	24,300	24,100	23,800	24,100	23,800
	4.30	35,000	—	—	—	—	26,600	26,300	—	—
	—	37,000	—	—	—	—	—	—	28,600	28,300
	4.88	32,500 ²	—	—	—	—	—	—	24,100 ²	23,800 ²
—	40,000 ²	—	—	—	—	—	—	31,600 ²	31,300 ²	

SUPERCAB										
6.2L 2-valve Gas V8 FFV	3.73	19,500	12,800	12,400	—	—	—	—	—	—
	—	20,000	—	—	12,600	12,200	—	—	—	—
	4.30	23,000	16,300	15,900	—	—	—	—	—	—
—	23,500	—	—	16,100	15,700	—	—	—	—	—
7.3L 2-valve Gas V8	3.73	22,500	—	—	15,100	14,700	—	—	—	—
	4.30	26,000	19,300	18,800	18,600	18,200	—	—	—	—
	4.88	28,000	—	—	—	—	20,100	19,700	20,100	19,700
6.7L Diesel V8	3.73	30,000	22,300	21,900	—	—	—	—	—	—
	—	31,500	—	—	23,400	23,000	—	—	—	—
	4.10	32,500	—	—	24,400	24,000	23,800	23,500	23,800	23,500
	4.30	35,000	—	—	—	—	26,300	26,000	—	—
	—	37,000	—	—	—	—	—	—	28,300	28,000
	4.88	32,500 ²	—	—	—	—	—	—	23,800 ²	23,400 ²
—	40,000 ²	—	—	—	—	—	—	31,300 ²	30,900 ²	

CREW CAB										
6.2L 2-valve Gas V8 FFV	3.73	19,500	12,600	12,200	—	—	—	—	—	—
	—	20,000	—	—	12,500	12,100	—	—	—	—
	4.30	23,000	16,100	15,700	—	—	—	—	—	—
—	23,500	—	—	16,000	15,600	—	—	—	—	—
7.3L 2-valve Gas V8	3.73	22,500	—	—	15,000	14,600	—	—	—	—
	4.30	26,000	19,100	18,500	18,500	18,100	—	—	—	—
	4.88	28,000	—	—	—	—	19,900	19,600	19,900	19,600
6.7L Diesel V8	3.73	30,000	22,100	21,300	—	—	—	—	—	—
	—	31,500	—	—	23,200	22,800	—	—	—	—
	4.10	32,500	—	—	24,200	23,800	23,700	23,400	23,700	23,400
	4.30	35,000	—	—	—	—	26,200	25,900	—	—
	—	37,000	—	—	—	—	—	—	28,200	27,900
	4.88	32,500 ²	—	—	—	—	—	—	23,600 ²	23,300 ²
—	40,000 ²	—	—	—	—	—	—	31,100 ²	30,800 ²	

ENGINES

	6.2L 2-Valve Gas V8 FFV	7.3L 2-Valve Gas V8	6.7L Power Stroke® V8 Turbo Diesel
Configuration	SOHC	OHV	OHV (32-valve)
Compression ratio	9.8:1	10.5:1	15.8:1
Horsepower@ rpm	385 @ 5,750 ³	350 @ 3,900	330 @ 2,600
Torque lb.-ft. @ rpm	430 @ 3,800 ³	468 @ 3,900	825 @ 2,000
Recommended fuel	Regular unleaded or E85	Regular unleaded	Ultra-low sulfur diesel or B20 (containing 20% or less biodiesel)
PTO Provision availability	Available	Available	Standard

SRW = single rear wheel DRW = dual rear wheel WB = wheelbase

¹F-350 DRW/F-450/F-550 weights shown are for 145.3" wheelbase Regular Cab, 167.9" wheelbase SuperCab or 179.8" wheelbase Crew Cab models. For 169.3," 191.9," 193.3," 203.8" and 205.3" wheelbase models, weights may be somewhat less (usually not more than 200 lbs., or 400 lbs. with 205.3" wheelbase). ²Requires High-Capacity Trailer Tow Package. ³Certified to SAE J1349. ⁴Restrictions may apply. See your dealer for details. ⁵Measured to inside of metal. ⁶Cross-sectional modulus calculated at back of cab. ⁷When properly configured. ⁸Ambulance Prep Package F-350 DRW: rear tire outside width is 95.2."

REAR AXLES

Configuration	Engine	Standard	Available
F-350 SRW	6.2L Gas	3.73 non-limited-slip	3.73 electronic-locking; 4.30 electronic-locking
	7.3L Gas	4.30 electronic-locking	
	6.7L Diesel	3.73 non-limited-slip	3.73 electronic-locking
F-350 DRW	6.2L Gas	3.73 non-limited-slip	4.30 limited-slip
	7.3L Gas	3.73 non-limited-slip	4.30 limited-slip
	6.7L Diesel	3.73 non-limited-slip	4.10 limited-slip
F-450 DRW	7.3L Gas	4.88 non-limited-slip	4.88 limited-slip
	6.7L Diesel	4.10 non-limited-slip	4.10 limited-slip; 4.30 limited-slip ⁴
F-550 DRW	7.3L Gas	4.88 non-limited-slip	4.88 limited-slip
	6.7L Diesel	4.10 non-limited-slip	4.10 limited-slip; 4.30 limited-slip; ⁴ 4.88 limited-slip ⁴

FRAMES

<p>Number of Crossmembers</p> <p>7 (145.3" WB)</p> <p>8 (167.9" WB, 169.3" WB, 179.8" WB)</p> <p>9 (191.9" WB, 203.8" WB, 193.3" WB)</p> <p>10 (205.3" WB)</p> <p>Max. Side Rail Section⁵ (height x width x thickness)</p> <p>7.50" x 2.74" x 0.28" (F-350)</p> <p>7.50" x 2.74" x 0.32" (F-450/F-550 145.3" WB, 169.3" WB, 167.9" WB, 179.8" WB, 203.8" WB)</p> <p>7.50" x 2.74" x 0.60" (F-450/F-550 191.9" WB, 193.3" WB, 205.3" WB; F-550 with the Payload Plus Upgrade Package)</p> <p>Section Modulus⁶</p> <p>12.7 cu. in.</p> <p>Frame Rail Yield Strength</p> <p>50,000 psi</p>
--

ALTERNATORS

	Engine	Standard	Available
XL, XLT	6.2L Gas	200-amp	240-amp
	7.3L Gas	240-amp	397-amp
	6.7L Diesel	240-amp	332-amp 397-amp
LARIAT	6.2L Gas	240-amp	—
	7.3L Gas	397-amp	—
	6.7L Diesel	322-amp	397-amp

DIMENSIONS / WEIGHTS

	REGULAR CAB											
	F-350 SRW 4x2/4x4	F-350 DRW ⁸ 4x2/4x4	F-350 DRW ⁸ 4x2/4x4	F-450 DRW 4x2/4x4	F-450 DRW 4x2/4x4	F-450 DRW 4x2/4x4	F-450 DRW 4x2/4x4	F-550 DRW 4x2/4x4	F-550 DRW 4x2/4x4	F-550 DRW 4x2/4x4	F-550 DRW 4x2/4x4	
Wheelbase	145.3"	145.3"	169.3"	145.3"	169.3"	193.3"	205.3"	145.3"	169.3"	193.3"	205.3"	
Cab-to-axle	60"	60"	84"	60"	84"	108"	120"	60"	84"	108"	120"	
EXTERIOR												
Height												
Top of cab to ground	79.1"/81.9"	79.3"/82.2"	79.2"/82.0"	82.6"/82.4"	82.4"/82.2"	82.3"	82.3"	82.6"	82.4"	82.5"/82.4"	82.4"	
Top of frame to ground	32.7"/34.9"	33.0"/34.8"	32.7"/34.4"	35.4"/35.5"	35.0"	34.8"	34.8"	35.4"	35.0"	34.8"	34.7"	
Width												
Between frame rails	34.1"	34.1"	34.1"	34.2	34.2"	34.2"	34.2"	34.2"	34.2"	34.2"	34.2"	
Axle clearance	9.0"/8.9"	8.4"/8.3"	8.4"	8.5"	8.6"	8.6"	8.6"	8.5"	8.6"	8.6"	8.6"	
Front track	68.3"	69.1"	69.1"	74.8"	74.8"	74.8"	74.8"	74.8"	74.8"	74.8"	74.8"	
Rear tire outside width	79.6"	92.2"	92.2"	93.9"	93.9"	93.9"	93.9"	93.9"	93.9"	93.9"	93.9"	
Overall length	230.7"	230.7"	254.8"	230.7"	254.8"	278.8"	290.7"	230.7"	254.8"	278.8"	290.7"	
Weights (lbs.)												
Max. GVWR ⁷	11,100/11,500	14,000	14,000	16,500	16,500	16,500	16,500	19,000	19,500	19,500	19,500	
Max. payload ⁷	4,870/4,860	7,940/7,550	7,900/7,500	9,850/9,540	9,790/9,450	9,610/9,300	9,550/9,230	12,310/12,000	12,750/12,410	12,570/12,260	12,510/12,190	

	SUPERCAB						CREW CAB					
	F-350 SRW 4x2/4x4	F-350 DRW ⁸ 4x2/4x4	F-450 DRW 4x2/4x4	F-450 DRW 4x2/4x4	F-550 DRW 4x2/4x4	F-550 DRW 4x2/4x4	F-350 SRW 4x2/4x4	F-350 DRW ⁸ 4x2/4x4	F-450 DRW 4x2/4x4	F-450 DRW 4x2/4x4	F-550 DRW 4x2/4x4	F-550 DRW 4x2/4x4
Wheelbase	167.9"	167.9"	167.9"	191.9"	167.9"	191.9"	179.8"	179.8"	179.8"	203.8"	179.8"	203.8"
Cab-to-axle	60"	60"	60"	84"	60"	84"	60"	60"	60"	84"	60"	84"
EXTERIOR												
Height												
Top of cab to ground	79.3"/82.0"	79.6"/82.2"	82.5"	82.5"/82.4"	82.7"/82.5"	82.5"	79.4"/82.1"	79.7"/82.3"	82.8"/82.6"	82.6"/82.5"	82.8"	82.6"
Top of frame to ground	32.3"/34.2"	32.6"/34.4"	35.0"	34.8"	34.9"/35.0"	34.8"	32.1"/34.0"	32.5"/34.3"	34.8"/34.9"	34.7"/34.8"	34.8"	34.8"/34.7"
Width												
Between frame rails	34.1"	34.1"	34.2"	34.2"	34.2"	34.2"	34.1"	34.1"	34.2"	34.2"	34.2"	34.2"
Axle clearance	9.0"	8.4"	8.6"	8.6"	8.6"	8.6"	9.0"/8.9"	8.4"	8.6"	8.6"	8.6"	8.6"
Front track	68.3"	69.1"	74.8"	74.8"	74.8"	74.8"	68.3"	69.1"	74.8"	74.8"	74.8"	74.8"
Rear tire outside width	79.6"	92.2"	93.9"	93.9"	93.9"	93.9"	79.6"	92.2"	93.9"	93.9"	93.9"	93.9"
Overall length	253.3"	253.3"	253.3"	277.4"	253.3"	277.4"	265.2"	265.2"	265.2"	289.2"	265.2"	289.2"
Weights (lbs.)												
Max. GVWR ⁷	11,500	14,000	16,500	16,500	19,500	19,500	11,500	14,000	16,500	16,500	19,500	19,500
Max. payload ⁷	4,970/4,940	7,600/7,200	9,550/9,190	9,360/9,030	12,510/12,150	12,320/11,990	4,830/4,820	7,460/7,040	9,380/9,070	9,230/8,940	12,340/12,030	12,190/11,900

INTERIOR (front/rear)	REGULAR CAB	SUPERCAB	CREW CAB
Head room	40.8"/—	40.8"/40.3"	40.8"/40.4"
Leg room (max.)	43.9"/—	43.9"/33.5"	43.9"/43.6"
Hip room	62.5"/—	62.5"/64.7"	62.5"/64.7"
Shoulder room	66.7"/—	66.7"/65.8"	66.7"/65.9"
Total passenger volume (cu. ft.)	64.6	116.0	131.8
Cargo volume behind 1st row (cu. ft.)	11.6	31.6	52.1

MECHANICAL

Max. Front Gross Axle Weight Rating (GAWR) (lbs.)	Front	Rear
F-350 SRW 4x2	5,250	7,230
F-350 SRW 4x4		



CLASS-EXCLUSIVE COLLAPSIBLE UNDER-SEAT STORAGE (Crew Cab)
Standard on XLT, LARIAT



100V/400W AC POWER OUTLET ON CENTER CONSOLE REAR (SuperCab/Crew Cab)
Standard on LARIAT; Available on XLT



BLACK VINYL FLOORING
Standard on XL; Available on XLT, LARIAT



REAR VIEW CAMERA AND PREP KIT
Available on ALL TRIMS

New Vehicle Limited Warranty. We want your Ford F-Series Super Duty® Chassis Cab ownership experience to be the best it can be. Under this warranty, your new vehicle comes with 3-year/36,000-mile bumper-to-bumper coverage, 5-year/60,000-mile Powertrain Warranty coverage, 5-year/60,000-mile safety restraint coverage, 5-year/unlimited-mile corrosion perforation (aluminum panels do not require perforation) coverage, and 5-year/100,000-mile diesel engine coverage (when applicable) – all with no deductible. Please ask your Ford Dealer for a copy of this limited warranty.

Roadside Assistance. Covers your vehicle for 5 years or 60,000 miles, so you have the security of knowing that help may be only a phone call away should you run out of fuel, lock yourself out of the vehicle or need a winch back to a paved road, a battery jump start or towing. Your Ford Dealer can provide complete details on all of these advantages.

Ford Commercial Vehicle Center. Each of the over 650 dealerships in our Commercial Vehicle Center (CVC) network is committed to providing quality commercial-oriented products and service, as well as special financing and billing arrangements, to businesses that rely on Ford products. As a CVC customer, your business vehicles receive priority service at your CVC dealership to help get your vehicle back on the road quickly.

Financial Services. Our commercial purchase plans and lines of credit offer attractive rates, negotiable terms and business-friendly options. If you prefer to lease, our CommercialLeaseSM programs offer a wide variety of package options to meet your needs. For additional information, please visit our website at fordcredit.com/comlend.

Ford Credit. Get the ride you want. Whether you plan to lease or buy, Ford Credit has the option that's right for you. Ask your Ford Dealer for details or visit us online at ford.com/finance.

Ford Protect™ Extended Service Plans. Whether you purchase or lease your Ford vehicle, insist on genuine Ford Protect extended service plans. Ford Protect has a variety of plans to give you peace-of-mind protection whether you want vehicle component or maintenance coverage. Plus, they are fully backed by Ford and honored at all Ford dealerships in the U.S., Canada and Mexico. When you visit your dealer, insist on genuine Ford Protect extended service plans.

Amazon, Alexa, and all related logos and marks are trademarks of Amazon.com, Inc. or its affiliates. Apple, Apple CarPlay, Apple Watch and iPhone are trademarks of Apple Inc., registered in the U.S. and other countries. App Store is a service mark of Apple Inc. BANG & OLUFSEN and B&O are registered trademarks of Bang & Olufsen Group. Licensed by Harman Becker Automotive Systems Manufacturing Kft. All rights reserved. Google, Android, Google Assistant, Google Play, Android Auto, Waze and other marks are trademarks of Google LLC. Requires the Android Auto app on Google Play and an Android compatible smartphone running Android™ 5.0 or higher. HD Radio is a proprietary trademark of iBiquity Digital Corporation. SiriusXM and all related marks and logos are trademarks of Sirius XM Radio Inc.

Comparisons based on competitive models (Class 3-5 Chassis Cabs based on Ford segmentation), publicly available information and Ford certification data at time of release. Vehicles may be shown with optional and aftermarket upfit equipment. Features may be offered only in combination with other options or subject to additional ordering requirements/limitations. Dimensions and capacity ratings shown may vary due to optional features and/or production variability. Information is provided on an "as is" basis and could include technical, typographical or other errors. Ford makes no warranties, representations, or guarantees of any kind, express or implied, including but not limited to, accuracy, currency, or completeness, the operation of the information, materials, content, availability, and products. Ford reserves the right to change product specifications, pricing and equipment at any time without incurring obligations. Your Ford Dealer is the best source of the most up-to-date information on Ford vehicles. Body manufacturers are responsible for compliance certification of the completed vehicle. The Ford New Vehicle Limited Warranty and any government certification made by Ford shall cover only the vehicle as manufactured by Ford and shall not extend to any addition, modification or change of or to the vehicle by the Ford Authorized Pool Account. Colors are representative only. See your dealer for actual paint/trim options.

[f](#) [t](#) [v](#) [i](#)
ford.com/commercial-trucks/chassis-cab

BACKED BY 650+ FORD COMMERCIAL VEHICLE CENTERS.



COMMERCIAL VEHICLES



There's a standard of excellence at your local Ford Commercial Vehicle Center dealer, where our certified experts are focused on offering an exceptional sales, service and finance experience. After helping you spec your Chassis Cab, our knowledgeable staff will help ensure it's built to your requirements. We can also recommend finance solutions and help maximize your "up-time" after the sale with prompt, specialized service. You'll find extended hours and service discounts at our Service and Parts Department, along with a Parts Advantage program that helps us keep the fastest-moving fleet parts in your area in stock. Learn more at www.fordcommercialvehiclecenter.com.

YOUR BUSINESS, YOUR EDGE.

Get help optimizing your fleet with available Ford Telematics™ fleet management software from Ford. How does it work? Your vehicles produce informative data from each journey. This data, driven through Ford Telematics, helps you monitor those vehicles to understand where they go, how they're used and how they're running. These actionable insights can give you more time to focus on the rest of your business. You can also use available Ford Data Services™ to access Ford generated vehicle data with other fleet systems or telematics service providers. We'll help you get the data you need the way you prefer. Learn more at www.commercialsolutions.ford.com.



From day one, we had the future in mind. And for over 116 years, we've focused on improving your freedom of movement, by making it possible for hardworking, everyday people to own a vehicle. One that's well built. That you're proud to drive. Born in Detroit, made in America¹ and famous worldwide:

We are the Ford Motor Company.

Your mobility is at the center of everything we do.

And we're excited to be designing and building smart vehicles that work for you. It's why we put our family name on every one.

From our founding members, to our Ford family of employees around the globe, we work with pride. We build with care.

For you – and your family. By everyone in ours.

¹Made in the USA with domestic and foreign parts.

