

2012 CATALOG
ENGINEERING A BETTER COMMUNITY

GMC SIERRA

SCULPTURE
IN THE PARK

WILD HORSE
SANCTUARY

HISTORIC-SHIP
REBUILDING

COMMUNITY-
SUPPORTED
AGRICULTURE





REAL LIFE. REAL PROJECTS. Making a real difference. GMC vehicles aren't made to sit in the showroom. They're designed, engineered and built to get things done, to defy the impossible and to never say the job is over until you've overachieved. This is why GMC has joined with the people and organizations you're about to meet. People who are making a difference in their communities and effecting real change. From advancing the arts to providing safe haven to an American icon, helping a community learn the value of locally grown produce or restoring an historic treasure, GMC is proud to present these stories of what can really happen in life when you never say never.

GMC. WE ARE PROFESSIONAL GRADE.



SIERRA 2500HD CREW CAB SLT IN ONYX BLACK Sierra is engineered to keep any task under control, with Trailer Sway Control and Hill Start Assist standard on all models. (Excluding Hybrid and Dual Rear Wheel (DRW) models.)

TABLE OF CONTENTS

2 - 25

PART 1

GMC COMMUNITY PROJECTS

- SCULPTURE IN THE PARK, 2
- WILD HORSE SANCTUARY, 8
- HISTORIC-SHIP REBUILDING, 14
- COMMUNITY-SUPPORTED AGRICULTURE, 20

Learn about the organizations and individuals GMC is partnering with who are committing their innovative spirit and uncompromising attitude to projects that make a long-lasting impact on their communities.

26 - 31

PART 2

FEATURES AND THEIR BENEFITS

The what, the where and the how of professional-grade engineering. It's everything you need to know about the 2012 GMC Sierra, from its bold styling to the 23,000 lbs of maximum fifth-wheel trailering capacity!

32 - 40

PART 3

SPEC YOUR MODEL

Compare all the options, check out the accessories and customize your own 2012 GMC Sierra.

QR CODES

HOW TO SCAN A QR CODE

Use your smartphone to scan the QR codes shown throughout the catalog. After scanning the code, your smartphone will be directed to a mobile site for more information on each project. If you do not have a QR code reader, simply download a free reader through the app store on your smartphone device.

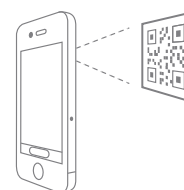

HOW TO USE THE URL IF YOU DON'T HAVE A SMARTPHONE

If you don't have a smartphone, you can still experience all the extra content by logging on to the Web and entering the Web address found next to the QR code.

*Based on Sierra 3500HD DRW 4WD with available 6.6L V-8 engine and fifth-wheel hitch. Maximum trailer weight ratings are calculated assuming a base vehicle, except for any option(s) necessary to achieve the rating, plus driver. The weight of other optional equipment, passengers and cargo will reduce the maximum trailer weight your vehicle can tow. See your GMC dealer for additional details. Vehicle shown with available equipment. Grille available fourth quarter 2011.

PROJECT
SCULPTURE IN THE PARK—BROOKLYN, NY

THE ART OF ENGINEERING ART.

Sculptor Robert Lobe is a quiet man, but his vision speaks volumes. Like the nature that inspires him, Lobe believes the meaning of art can't be restrained. It can't be confined to a canvas or seen only in a museum. To Lobe, the idea of art is bigger than a gallery or an exhibition. It happens every day and it happens all around us.

So he set out to put art where the people are.

A New York-based artist, Lobe uses items like rocks and trees to shape sculptures that highlight the random beauty of life itself. Although his work has been displayed around the world, for his latest series, "Nature in Nature," he wanted to bring it a little closer to home, namely Brooklyn's own Prospect Park. But how do you move half-ton sculptures from a studio in New Jersey to the heart of New York City? You start by never saying never. With GMC's help, Lobe had the power to haul his three half-ton sculptures to the site, the capability to navigate works of art through the hustle of the city and the bold thinking to see the project through to completion.

BUT WHAT CAN THE IDEA OF PUBLIC ART SAY ABOUT THE THINKING BEHIND THE GMC SIERRA?

It says that true inspiration will always make an impact, and great ideas should never be confined by convention. Which is why Sierra HD offers something no other competitor can: a best-in-class 1-ton maximum fifth-wheel trailer weight rating of up to 23,000 lbs.¹

It says that compromise should never have a place in art or engineering. Which is why Sierra HD offers the only available fully automatic locking rear differential in its class. And it makes it all the more obvious that with professional grade, even everyday life can be like a work of art.

GMC SIERRA.



FOR MORE OF THE STORY, SCAN THE QR CODE WITH YOUR
SMARTPHONE OR VISIT GMC.COM/SIERRA_SCULPTURE

SIERRA 3500 DENALI HD DRW, FOLLOWED BY SIERRA 2500 DENALI HD, BOTH IN ONYX BLACK The widest selection of V-8 power and up to 23,000 lbs of fifth-wheel trawling capacity¹ mean no matter what job you're planning, a Sierra truck is your blueprint for success.



¹Sierra 3500HD Regular Cab DRW 4WD with available 6.6L V-8 engine and fifth-wheel hitch. Maximum trailer weight ratings are calculated assuming a base vehicle, except for any option(s) necessary to achieve the rating, plus driver. The weight of other optional equipment, passengers and cargo will reduce the maximum trailer weight your vehicle can tow. See your GMC dealer for additional details. Vehicles shown with available equipment. Grille available fourth quarter 2011.



↑ **SIERRA DENALI INTERIOR IN EBONY**
Sierra Denali's remarkably quiet interior adds to the premium comfort of its refined ride.

↓ Sierra Denali's standard Tow/Haul mode is easily controlled from the steering wheel gear shift, giving you more control of your power, whether you're going uphill or coming down.

↓ Sierra Denali's steering-wheel-mounted controls allow convenient access to radio volume and Bluetooth® phone, without taking your eyes off the road.





↓ Sierra Denali keeps any trip comfortable with heated and cooled front seats that are easily controlled by a push of a button.

↓ Perforated leather-appointed seating comes standard in Sierra Denali.





↑ SIERRA DENALI, SIERRA 2500 DENALI HD AND SIERRA 3500 DENALI HD DRW, ALL IN ONYX BLACK Sierra Denali's iconic front grille makes a striking statement wherever it goes.

↓ Our strongest, most powerful, most capable Sierra HD pickups ever.



THE TALENT BEHIND SCULPTURE IN THE PARK

GMC SIERRA

Robert Lobe's "Nature in Nature" exhibition is three separate sculptures that have been installed in Brooklyn's Prospect Park. Lobe, a sculptor whose work has appeared around the world, created "Nature's Clock," "Invisible Earth" and "Antique Jenny" for specific sites on the grounds of the park's historic boathouse, to be enjoyed by the public in a natural setting.



↓ Artist Robert Lobe.

↓↓ Assistants wait for final instructions.

↓ Lobe makes a final inspection before transporting "Invisible Earth" to Brooklyn.

↑ "Invisible Earth" begins its move into place in the Lullwater around the boathouse.



↓ The team guides the trailer containing "Invisible Earth" into the water.

↓ Three Sierra Denalis were used to transport the sculptures to the park.



 To join the conversation about these projects, or to learn how people are making a difference, visit [facebook.com/gmc/projects](https://www.facebook.com/gmc/projects) and look for "Community Projects."

Vehicles shown with available equipment.

PROJECT
WILD HORSE SANCTUARY—LOMPOC, CA

THE BIGGEST JOBS DEMAND BOLDER THINKING.

There's an American symbol that's about to disappear.

After years of eroding habitat and destructive policies, the wild horses of the western landscape are rapidly fading away. But nestled in California's Jalama Valley is a place that refuses to let that happen. It's a place that never says never.

The Return to Freedom Sanctuary has rescued over 1000 wild horses and burros, preserving entire herd groups. The animals have room to roam and run free, and genetic bloodlines are kept intact. With GMC's help, Return to Freedom was able to complete much needed maintenance and improvements to the ranch's land and infrastructure, providing a safer and more secure environment and helping advance the mission of the sanctuary itself: to protect the freedom, diversity and habitat of America's wild horses for generations to come.

**IT'S A BIG JOB. BUT THEY KNOW THEY'RE UP FOR THE CHALLENGE.
GMC SIERRA WAS BUILT WITH THAT SAME CONFIDENCE.**

Designed to see big challenges as bigger opportunities, Sierra was engineered to exceed. Heavy-duty trailering equipment, chrome-clad 18-inch aluminum wheels and distinctive badging set Sierra All-Terrain apart from the rest. The famed Z71 Off-Road Suspension, Rancho Tenneco shocks and an Eaton® automatic locking rear differential mean no matter how far away the job takes you, you're bound to make it back.

Sierra Heavy Duty was built on the strongest HD pickup frame GMC has ever constructed. With an available Duramax Diesel engine that produces 397 hp and 765 lb-ft of torque, it makes it the most powerful GMC HD pickup ever. It's what gives you the confidence to know you can carry the weight, the self-reliance that comes from shouldering the load and is the difference between just driving a truck and commanding a Heavy Duty. **GMC SIERRA.**



FOR MORE OF THE STORY, SCAN THE QR CODE WITH YOUR
SMARTPHONE OR VISIT GMC.COM/SIERRA_SANCTUARY

SIERRA ALL-TERRAIN IN QUICKSILVER METALLIC

A four-bar horizontal chrome grille, chrome-accented molding and bold All-Terrain badging set this Sierra apart from the rest.





↑ **SIERRA BODY-COLOR ALL-TERRAIN IN SUMMIT WHITE** Sierra's Body-Color Package with its 20" chrome-clad wheels¹ give this All-Terrain a unique presence, on the road and off.

↓ An available two-toned interior, unique sill plates and brushed aluminum accents are just a few of the highlights of the All-Terrain's interior.



¹Use only GM-approved tire and wheel combinations. For approved tire and wheel combinations and other important information, go to gmaccessorieszone.com or see your dealer for details.



↓ Sierra's All-Terrain Packages are available on 1/2-ton 2WD or 4WD Extended or Crew Cab models with either the 5.3L V-8 VVT or 6.2L V-8 VVT and the legendary Z71 Off-Road Suspension.





↑ **SIERRA 3500HD CREW CAB SLT DRW IN QUICKSILVER METALLIC** For maximum strength, Sierra HD's fully boxed frame features high-strength alloy steel to resist sagging and bending, giving it the strongest frame we've ever built into an HD pickup.

↓ Sierra is up for the challenge of hauling more in every load, with select models offering up to 7215 lbs of maximum payload capacity!¹

↓ The Sierra HD lineup offers up to 23,000 lbs maximum fifth-wheel trailering² and a best-in-class weight carrying hitch capability of up to 18,000 lbs,³ so it's ready, willing and capable to take on any task.



¹Sierra 3500HD Regular Cab DRW with 6.0L V-8 engine. Maximum payload capacity includes weight of driver, passengers, optional equipment and cargo. ²Sierra 3500HD Regular Cab DRW 4WD with available 6.6L V-8 engine. Maximum trailer weight ratings are calculated assuming a base vehicle, except for any option[s] necessary to achieve the rating, plus driver. The weight of other optional equipment, passengers and cargo will reduce the maximum trailer weight your vehicle can tow. See your GMC dealer for additional details. ³Capacity available fourth quarter 2011. Maximum trailer weight ratings are calculated assuming a base vehicle, except for any option[s] necessary to achieve the rating, plus driver. The weight of other optional equipment, passengers and cargo will reduce the maximum trailer weight your vehicle can tow. See your GMC dealer for additional details.

THE STORY BEHIND RETURN TO FREEDOM

GMC SIERRA

Return to Freedom is a nonprofit wild horse sanctuary founded in 1997 by Neda DeMayo. The realization of her life-long dream, the sanctuary's mission is to protect the freedom, diversity and natural lifestyle of America's free-range wild horses, becoming the first sanctuary to focus on rescuing entire family bands of wild horses.



↓ Loading supplies for fence repair.

↑ Neda DeMayo, Founder of Return to Freedom; Aaron Thayne, natural hoof care practitioner; Albert Villasevil Florensa, Veterinarian; Daniel Reader, Association for the Advancement of Natural Horse Care Practices—Apprentice and Peter Wright, Return to Freedom Ranch Manager, planning the next round of vaccinations and hoof trimming at the wild horse holding facility in Fallon, NV.



↓ Albert Villasevil Florensa (left) and Aaron Thayne trimming hooves at the Fallon Cattle and Feed facility in Fallon, NV.



↓ Neda Demayo and her parents, William and Stella, next to an authentic 1956 GMC Model 101.

↓ One of the natural herd groups successfully rescued by the sanctuary.



 To join the conversation about these projects, or to learn how people are making a difference, visit facebook.com/gmc and look for "Community Projects."

PROJECT
HISTORIC-SHIP REBUILDING – ALBANY, NY

CRAFTSMANSHIP COUNTS. IN THE 17TH CENTURY OR THE 21ST.

Can you rebuild a 400-year-old Dutch sailing vessel by hand, with only the help of volunteers? You can if you never say never.

When a group of New York Capital District residents wanted to educate people about the historic contribution the Dutch made to North America, they realized the best way to teach something is to do something. So they set out to reconstruct the Onrust (Dutch for “Restless”), the first trading ship built in America, and use it as a living and floating classroom.

Over the span of 3 years, using authentic 17th-century Dutch building techniques and a healthy dose of determined perseverance, they rebuilt the ship to its authentic 1614 specifications, and brought an important part of American history back to life.

SO WHAT DOES 17TH-CENTURY SHIPBUILDING SAY ABOUT THE ENGINEERING OF THE GMC SIERRA?

That true craftsmanship is timeless. That it's in the details where you find the difference. And no matter what the task, the biggest challenges can always be conquered if you have the right plan. That's the same attitude that's built into every Sierra. It's why Sierra offers you over 300 horsepower and 22 EPA-estimated highway miles per gallon in the same engine—V-8 fuel economy that no other competitor can beat. It's why Sierra offers advanced technology like Active Fuel Management, maximizing your engine's performance to give you power and efficiency as you need it.

And it's why it's as true today as it was back then: When you need to rely on something to keep your life on course, there is no substitute for professional-grade engineering. **GMC SIERRA.**



FOR MORE OF THE STORY, SCAN THE QR CODE WITH YOUR
SMARTPHONE OR VISIT GMC.COM/SIERRA_SHIP



SIERRA 1500 CREW CAB SLT IN QUICKSILVER METALLIC
No competitor has better V-8 fuel economy than Sierra, with the XFE model offering an EPA-estimated 22 hwy mpg in addition to 315 hp.

PART 1 : HISTORIC-SHIP REBUILDING-ALBANY, NY

VEHICLE SHOWN : SIERRA 1500

FEATURES : SEE PAGES 28-29 FOR MORE DETAILED INFORMATION ON CHASSIS AND SUSPENSION



SIERRA 1500 CREW CAB SLT INTERIOR IN EBONY
Sierra's organized and easy-to-reach instrumentation and controls highlight the smart, driver-oriented layout of its interior.



SIERRA 1500 CREW CAB SLT INTERIOR IN EBONY
Sierra's attention to detail is evident in the leather-appointed front seats and spacious center console.



↑↑ **SIERRA 1500 EXTENDED CAB SLE IN FIRE RED** (also below)

↑ The available multifunctional center console offers surprising storage and convenience, plus access to a lockable storage compartment underneath with room for notebooks and electronic devices, as well as an auxiliary power outlet.

↑ The dual-level glove box provides plenty of space for a wide range of necessities, letting you organize everything for quick access and secure storage.

↑ **SIERRA 1500 EXTENDED CAB SLE INTERIOR IN DARK TITANIUM CLOTH**
Sierra's interior is designed for optimal comfort and convenience, keeping you connected and focused on the task at hand.



THE PEOPLE BEHIND THE ONRUST PROJECT

GMC SIERRA

Contributing skills, time and hard work, over 250 volunteers came together to help reconstruct America's first Dutch trading ship, the Onrust. Utilizing recently rediscovered authentic Dutch shipbuilding techniques, the reconstruction isn't merely a replica but an actual working 17th-century Dutch ship, built the same way the original was some 400 years ago.



↓ Volunteers work to build some of the remaining pieces of the Onrust.
↓ Greta Wagle, Project Director of the Onrust Project.
↓ Don Rittner, President of the Onrust Project, straightening the sails.

↓ The Onrust setting sail on the Hudson River, Albany, NY.

↑ Two proud vessels stand side by side as Sierra is parked in front of the Onrust.

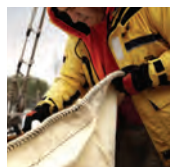

↓ Sierra stands ready to haul some of the white oak lumber used to construct the Onrust.



↓ Woodworking materials.

↓ GMC trucks also helped trailer wood for the Onrust.



 To join the conversation about these projects, or to learn how people are making a difference, visit [facebook.com/gmc](https://www.facebook.com/gmc) and look for "Community Projects."

Vehicles shown with available equipment.

PROJECT

COMMUNITY-SUPPORTED AGRICULTURE – BRADENTON, FL

USING TECHNOLOGY TO PULL A COMMUNITY FORWARD.

In Bradenton, FL, there's a group of people with a never-say-never attitude and a bold idea for community farming: that the community is just as important as the farming. To them, the job is bigger than just growing food; it's about growing the health of the entire area. Geraldson Community Farm uses the latest sustainable growing methods to produce healthy, safe food for their members and the surrounding area, donating nearly 1000 pounds of excess food to the local food bank last year alone.

With GMC's help, the farm finished installing the cisterns for their water retention system and constructing their community barn, both projects being key steps toward accomplishing their goal of a zero carbon footprint and educating the public on the benefits of locally grown food. Using the farm as both a working classroom and library, they provide the community with the resources they need to learn the best, most efficient ways to farm for themselves.

BUT WHAT DOES COMMUNITY-SUPPORTED AGRICULTURE HAVE TO DO WITH ENGINEERING TRUCKS?

It's using technology to work more efficiently, just like the engineering behind Sierra Hybrid. America's first two-mode Hybrid on a full-size pickup, Sierra Hybrid was built to take the best of both gas and electric propulsion to provide the most efficient power in any given driving situation. With multiple fuel-saving technologies working together to make it the most advanced full-size pickup available, Sierra Hybrid gives you up to 66 percent better city fuel economy than anyone else in its class.¹ It's conservation without any compromise. It's engineering that stays ahead of tomorrow by setting the pace today. And it's what sets Sierra apart from all the rest. **GMC SIERRA.**



FOR MORE OF THE STORY, SCAN THE QR CODE WITH YOUR
SMARTPHONE OR VISIT GMC.COM/SIERRA_PRODUCE



SIERRA HYBRID CREW CAB IN QUICKSILVER METALLIC
With the power of Sierra Hybrid's standard automatic locking rear differential on your side, you can be confident the job gets done, even in some of the roughest conditions.

SIERRA HYBRID IN QUICKSILVER METALLIC The strength of 332 horsepower combined with the efficiency of an EPA-estimated 20 city/23 hwy mpg means Sierra Hybrid truly gives you conservation without compromise.







↑ **SIERRA CREW CAB SLT INTERIOR IN LIGHT TITANIUM** Available touch-screen navigation,¹ easy-to-read gauge cluster and durable, well-thought-out interior amenities make even the toughest jobs a little more comfortable.

↓ **SIERRA 2500HD CREW CAB SLT IN QUICKSILVER METALLIC** With up to 17,800 lbs of $\frac{3}{4}$ -ton max fifth-wheel trailering,² hauling water cisterns is just another job for Sierra HD.



¹Map coverage for Puerto Rico and the U.S. Virgin Islands available on separate disc. Coverage not available for portions of Canada. ²Sierra 2500HD Regular Cab 2WD with available 6.6L V-8 engine and fifth-wheel hitch. Maximum trailer weight ratings are calculated assuming a base vehicle, except for any option(s) necessary to achieve the rating, plus driver. The weight of other optional equipment, passengers and cargo will reduce the maximum trailer weight your vehicle can tow. See your GMC dealer for additional details.

THE PEOPLE BEHIND THE GERALDSON COMMUNITY FARM

GMC SIERRA

Since 2005, the Geraldson Community Farm has operated as a community-supported agriculture program, an innovative way to connect local consumers with local farmers. Paying for seeds, equipment and labor, 180 members have invested financially in the farm. Each week they come to the farm to receive a portion of that week's harvest.



↓ Farm hands load the Sierra's bed with wood chips.

↓ On the road in Bradenton, FL.

↑ Jacob Leech is the Farm Manager at Geraldson.



↑ Lee Clarkson, Farm Apprentice, hitches the refrigeration trailer to the Sierra.

↓ Lee Clarkson uses Sierra's capability to good advantage on the farm.

↓ Claudie Babineaux, Farm Apprentice, and with the help of Geraldson's entrepreneur program, a future farmer herself.



 To join the conversation about these projects, or to learn how people are making a difference, visit facebook.com/gmc and look for "Community Projects."

POWERTRAIN

1500 ENGINES

VORTEC ENGINES To give you uncompromised power and torque for confident daily driving, passing and trailering, look no further than the Vortec engine family. Each model uses innovative "vortex technology" to swirl and tumble the incoming air and fuel for optimum power and response.

Vortec 4.3L V-6 [LU3]
HORSEPOWER: 195 hp @ 4600 rpm TORQUE: 260 lb-ft @ 2800 rpm

Vortec 4.8L V-8 VVT [L20]
HORSEPOWER: 302 hp @ 5600 rpm TORQUE: 305 lb-ft @ 4600 rpm
FlexFuel Capable

Vortec 5.3L V-8 VVT [LMG]
HORSEPOWER: 315 hp @ 5200 rpm TORQUE: 335 lb-ft @ 4000 rpm
Active Fuel Management/FlexFuel Capable

Vortec 5.3L V-8 VVT [LC9]
HORSEPOWER: 315 hp @ 5200 rpm TORQUE: 335 lb-ft @ 4000 rpm
Active Fuel Management/FlexFuel Capable

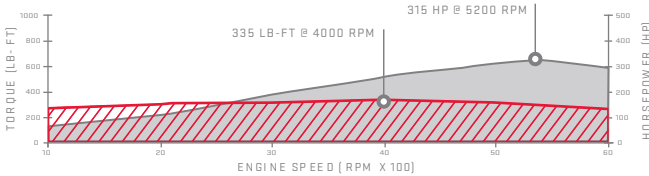

Vortec 6.2L V-8 VVT [L9H]
HORSEPOWER: 403 hp @ 5700 rpm TORQUE: 417 lb-ft @ 4300 rpm
FlexFuel Capable

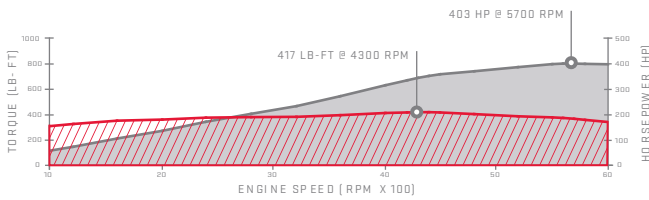

VARIABLE VALVE TIMING (VVT) For easy responsiveness in low-speed city driving and bold power for open-road passing or trailering, many Vortec engines feature VVT. It monitors and changes valve open and close points for near-peak levels of torque across the entire range of engine speeds.

ACTIVE FUEL MANAGEMENT (AFM) For maximum fuel economy when your load is light, and maximum V-8 power when it isn't, Sierra 5.3L and 6.0L V-8 engines use the advanced technology of Active Fuel Management. This available system senses load and demand then seamlessly activates or deactivates four of the engine's eight cylinders (below). In the Sierra XFE model, this technology results in best-in-class V-8 EPA-estimated highway fuel economy of 22 mpg.¹

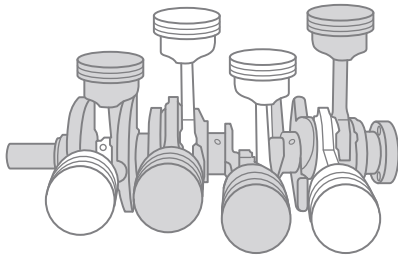

One of the key components of AFM is a specially designed valve lifter (above right). Under low-load conditions, pressurization of the valve lifter's switching mechanism deactivates the cylinder. Under high-demand conditions, the switching mechanism is depressurized, reengaging the cylinder and restoring full power as you need it, without ever noticing the transition.

POWERTRAIN

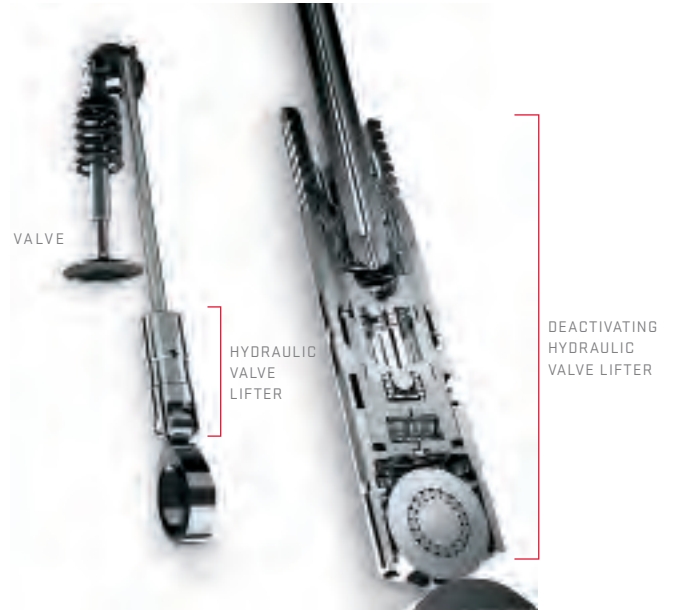

HEAVY DUTY ENGINES

VORTEC 6.0L V-8 VVT [L96] For strong, steady power at a standstill to bold acceleration on the highway, the 6.0L V-8 is up to the task and then some. Thanks to VVT technology, this engine can dig in at low speed to move a cabin cruiser up a boat ramp without complaint. It can just as easily apply its full power for safe highway passing or offer up the muscle to conquer a steep grade.

Vortec 6.0L V-8 VVT [L96]
HORSEPOWER: 360 hp @ 5400 rpm TORQUE: 380 lb-ft @ 4200 rpm
FlexFuel Capable

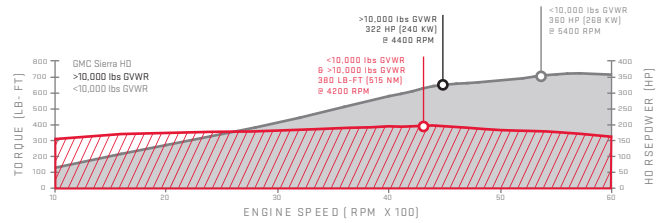

E85 FLEXFUEL CAPABILITY² To give you more choices at the pump for 2012, the 6.0L V-8 [L96] is capable of running on E85 ethanol. This advanced biofuel is a mostly renewable fuel that burns cleaner than gasoline and helps to reduce the need for imported oil.

DURAMAX DIESEL 6.6L V-8 TURBO For off-the-chart horsepower and torque with off-the-map range, the choice is Duramax. With advanced diesel direct-injection technology that helps it start in as little as 3.0 seconds at -40°F and a sophisticated Allison transmission with overdrive, this available powertrain can give you a maximum highway range of up to 680 miles on a single fill-up, thanks to its extra-large 36-gallon fuel tank.

Duramax Diesel 6.6L V-8 Turbo
HORSEPOWER: 397 hp @ 3000 rpm TORQUE: 765 lb-ft @ 1600 rpm

DURAMAX B20 BIODIESEL CAPABILITY To reduce carbon-dioxide emissions and stretch your fuel budget further, the Duramax 6.6L is engineered to operate on B20 biodiesel, a mixture of 20 percent biodiesel produced from domestic, renewable resources, and 80 percent petroleum diesel.

DURAMAX HIGH-PRESSURE DIRECT INJECTION For fast starts in cold weather, quieter operation and maximum efficiency, the direct injection system operates at nearly 30,000 psi to turn heavy diesel fuel into a fine mist, burning clean and fast with lower emissions and greater power than the previous model.

¹Based on GM 2011 Large Pickup segment. ²E85 is a blend of 85 percent ethanol and 15 percent regular gasoline. Visit gmc.com and search E85 for more information on E85 as an alternative fuel.

SIERRA 3500HD WITH DURAMAX DIESEL AND ALLISON TRANSMISSION

DURAMAX DIESEL 6.6L V-8 TURBO

ALLISON 1000 SERIES 6-SPEED
 AUTOMATIC WITH OVERDRIVE

UP TO 680-MILE HIGHWAY
 RANGE WITH AVAILABLE
 DURAMAX DIESEL ENGINE¹

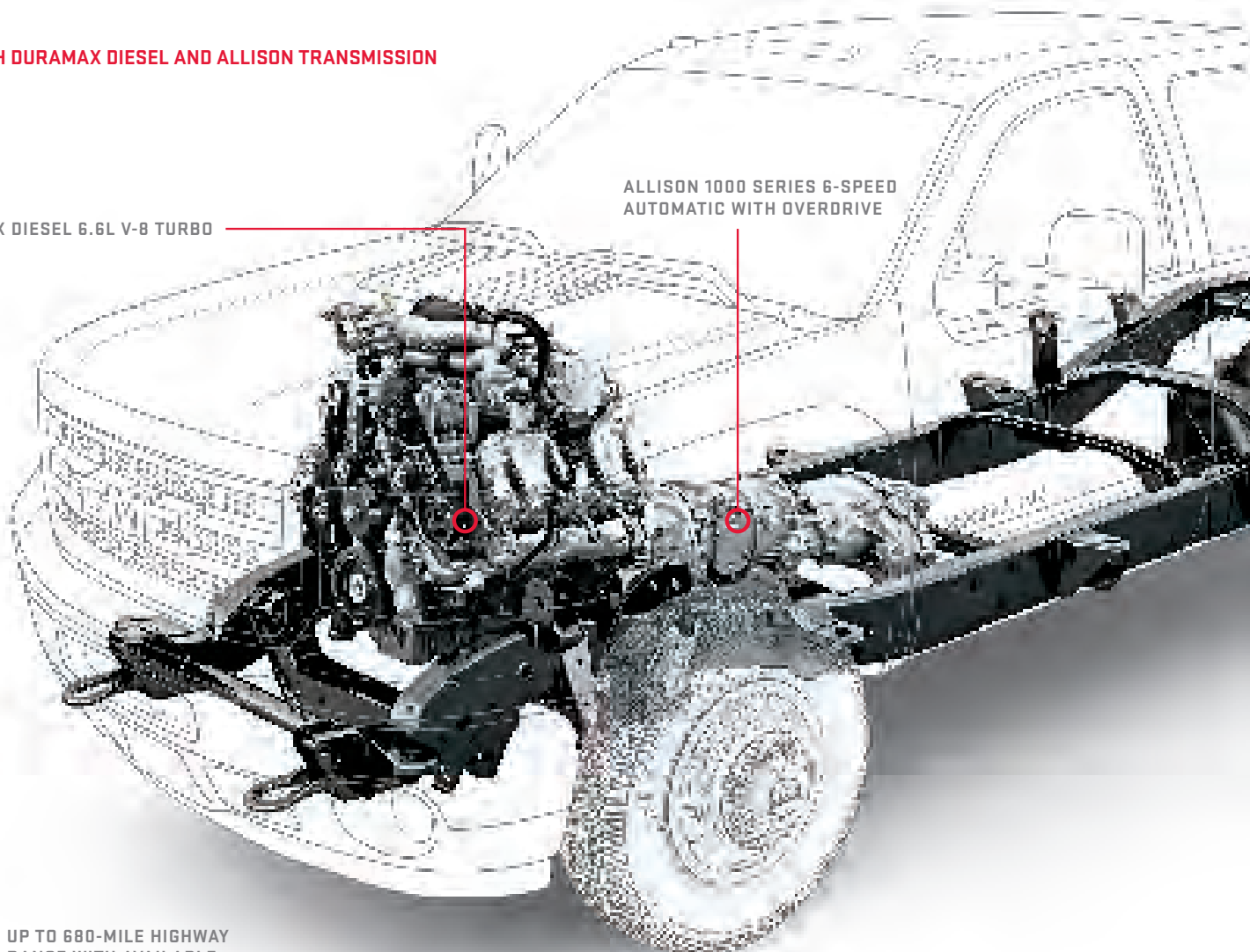

POWERTRAIN

ALLISON 1000 SERIES 6-SPEED AUTOMATIC WITH OVERDRIVE Produced by the same company that makes transmissions for the U.S. Army M1 tank, this transmission is the exclusive partner for the available Duramax Diesel engine. It has many features that help to handle the most challenging drives with ease.

ALL SIERRA TRANSMISSIONS

AUTOMATIC GRADE BRAKING Activated in Tow/Haul mode, Grade Braking automatically senses when you want to slow your Sierra, and when the conditions are met, engages a Grade Braking shift schedule that helps you maintain your desired speed.

TOW/HAUL MODE To give you more power to accelerate, Tow/Haul mode raises transmission up-shift points. This feature also helps you slow your Sierra by raising downshift points, which helps you to use engine compression to slow your Sierra with less noise and harshness.

CHASSIS

1500 CHASSIS AND SUSPENSION

EATON® HEAVY-DUTY AUTOMATIC LOCKING REAR DIFFERENTIAL No other competitor in its class offers an available fully automatic locking rear differential for on- or off-road use. When the Eaton Locker senses a difference in speed between left and right rear wheels of approximately 100 rpm, it locks to turn both rear wheels in unison for added traction.

CHASSIS AND SUSPENSION

BOXED HIGH-STRENGTH STEEL FRAME For resistance to bending, twisting and shaking, the GMC Sierra has a fully boxed frame from the nose to the spare tire area. This construction technique essentially welds a frame inside a frame to create a closed “box” section that gives a strong, stable platform for the engine and cab.



FULLY INDEPENDENT FRONT SUSPENSION Our coil-over-shock front suspension delivers improved ride quality versus torsion-bar designs.

STABILITRAK STABILITY CONTROL SYSTEM The StabiliTrak stability control system helps you stay on the path you are steering in bad weather or on uneven road surfaces. The system senses when your vehicle is not responding to your steering inputs, then adjusts engine speed and braking pressure to any individual wheel to help maintain directional control.

MULTILEAF REAR SPRINGS For big capacity when you need it and a smoother ride when you don't, Sierra's multileaf rear springs engage progressively as the load in the bed or on the hitch increases.

¹Based on GM testing.

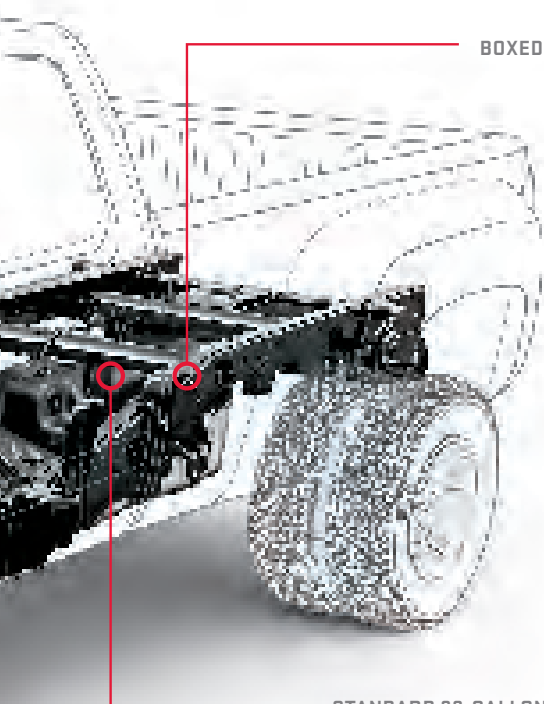

BOXED HIGH-STRENGTH STEEL FRAME

STANDARD 36-GALLON FUEL TANK

CHASSIS AND SUSPENSION

HEAVY DUTY CHASSIS AND SUSPENSION

FULLY BOXED HIGH-STRENGTH STEEL FRAME Not just a beefed-up light-duty frame, the Sierra HD frame is specifically engineered for HD use. Crafted from high-strength steel, the HD frame is fully boxed along its entire length, with fully welded (not riveted) brackets and cross-members. Tubular cross-members are through-rail welded for significantly added strength and resistance to twisting over rough or uneven surfaces.

FIFTH-WHEEL FRAME MOUNT PROVISIONS Easier, faster installation of fifth-wheel and gooseneck hitches is possible because GMC engineers planned it that way. They added prepierced access holes to preserve frame integrity as well as a pair of extra cross-members for added strength in the hitch-mount location.

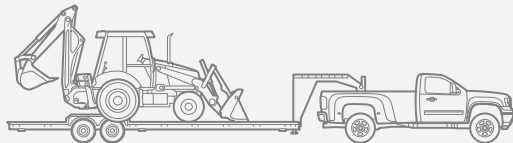

3500HD 4WD REG. CAB, DURAMAX 23,000 LBS (MAX) TRAILERING CAPACITY²

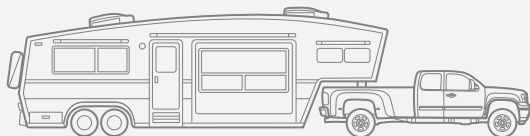

3500HD 2WD EXT. CAB, DURAMAX 22,800 LBS (MAX) TRAILERING CAPACITY²

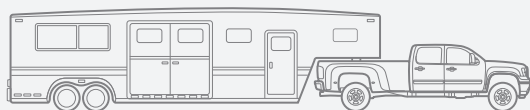

3500HD 2WD CREW CAB, DURAMAX 22,800 LBS (MAX) TRAILERING CAPACITY²

CHASSIS AND SUSPENSION

INDEPENDENT FRONT SUSPENSION For ride comfort with no sacrifice to strength, Sierra HDs have an independent front suspension designed specifically for the constant punishment of HD use. With an available unsurpassed pickup Gross Front Axle Rating of up to 6000 lbs,³ this torsion-bar suspension design allows you to make seasonal ride-height adjustments in minutes, with a single wrench.

MULTI-STAGE REAR LEAF SPRINGS The more load your HD takes, the more its springs step up to the challenge. Rear leaf springs are 3 inches wide—two-stage for 2500HD models and three-stage for 3500HD models.

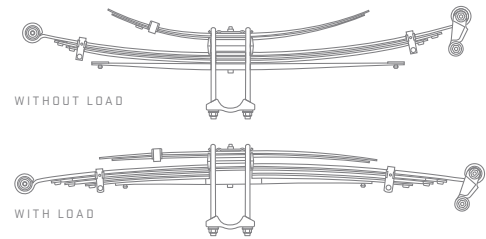

TORSION BAR DESIGN Pioneered for pickups by GMC over half a century ago, the torsion bar is designed to support different front axle loads and to retain proper trim height.

CONTROL AND RESPONSE

1500 BRAKING

ANTILOCK BRAKING SYSTEM (ABS) For confident stops in a variety of conditions, every Sierra features four-channel antilock brakes. When the brakes are applied, ABS can detect impending wheel lock-up and then pulse that wheel's brake to prevent it. The system can activate any combination of vehicle brakes to maintain control.

HILL START ASSIST To help you hold your place when parked on a hill, Hill Start Assist senses potential "roll-back" and then holds full brake pressure when you lift your foot from the pedal. It gives you up to 1.5 extra seconds to apply power and drive off. (Not available on Hybrid or DRW models.)

INTELLIGENT BRAKE ASSIST In an abrupt stop, milliseconds can be your margin of safety. That's why Sierra's Intelligent Brake Assist senses when you are making an emergency stop, then automatically applies full braking force before your foot can press the pedal all the way. (Not available on DRW models.)

TRAILER BRAKE CONTROLLER For fingertip control and easy monitoring of your trailer brakes, Sierra offers an integrated trailer brake controller. It is located close to the steering wheel for easy adjustments and displays the level of brake force or "gain" in the Driver Information Center.

TRAILER SWAY CONTROL Keep both you and your trailer heading in the proper direction, automatically. This system uses StabiliTrak sensors to detect the rocking of a swaying trailer, and then applies the vehicle's brakes to bring it back in line. The only thing you feel is the confidence. (Not available on Hybrid or DRW models.)

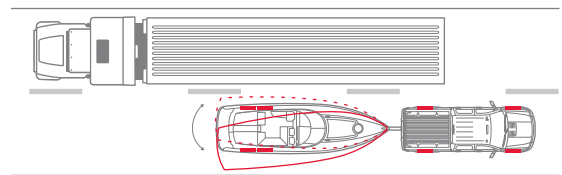

1500 STEERING

POWER RACK-AND-PINION STEERING Provides a positive on-center feel at highway speeds, as well as extra low-speed assist for maneuvering in tight spaces.

²Maximum trailer weight ratings are calculated assuming a base vehicle, except for any option(s) necessary to achieve the rating, plus driver. The weight of other optional equipment, passengers and cargo will reduce the maximum trailer weight your vehicle can tow. See your GMC dealer for additional details. ³Capacities and weight ratings are dependent upon model, engine, transmission and GVWR combinations. See your GMC dealer for details.

HEAVY DUTY STEERING

POWER STEERING Sierra HD models feature recirculating ball power steering. The high-capacity power steering pump and large reservoir help to give a constant level of assist, even when operating at the maximum weight.

HEAVY DUTY BRAKING

DIESEL EXHAUST BRAKE To let you engage an extra measure of braking confidence on long grades, the diesel exhaust brake, included with the available Duramax Diesel engine, uses engine compression to create "negative torque" to help slow the vehicle. It is factory installed and calibrated to work with the rest of your Sierra HD's braking system.

POWER FOUR-WHEEL DISC BRAKES The most powerful HD we've ever produced demanded the most powerful brakes we've ever developed for an HD pickup. They measure a generous 14" in diameter and utilize twin piston calipers.

STYLING AND FUNCTIONALITY

ASSIST STEPS Gain a more secure foothold for easier entry. GMC Sierra pickups are available with sturdy rust-resistant assist steps. They are available in chrome or powder black finishes.

HEATED POWER RETRACTABLE MIRRORS These available mirrors are heated to remove snow, frost and fogging, and feature integrated turn indicators that signal your intentions to other drivers. The driver's side mirror dims automatically to deflect glare away from your line of sight. Both mirrors fold back for extra clearance in close parking situations or to help prevent damage in automatic car washes.

VERTICAL CAMPER-STYLE MIRRORS Available manual-folding mirrors (standard on 3500HD models) come with a lower convex spotter glass for wider visibility. Available heated, power-adjustable mirrors feature integrated turn signal indicators and manually fold or extend out from the vehicle. The lower convex mirror is not heated.

COMFORT AND CONVENIENCE

BLUETOOTH®¹ FOR PHONE Extend your capabilities just by activating the available Bluetooth feature on your phone or portable device. This lets your Bluetooth device work through the controls and features already installed in your Sierra, including hands-free operation and dialing.

CLIMATE CONTROL All Sierra models are equipped with air conditioning. SLT and Denali models have automatic dual-zone climate controls with individual settings for the driver and right-front passenger.

DRIVER INFORMATION CENTER Staying in touch with the most important vehicle information is as easy as pressing a button. The Driver Information Center includes the odometer and trip odometers, as well as a message center that keeps you informed about vital vehicle functions and driving conditions. SLE, SLT and Denali include a compass and outside temperature indicator.

HEATED FRONT SEATS Feel warmer faster in cold weather. These available seats allow you to select from three heat settings.

HEATED AND COOLED FRONT SEATS The ultimate in all-weather comfort, these seats are appointed in a perforated leather that allows the cooling feature to circulate air between you and the seat surface. They are standard on Denali and available on SLT models.

POWER-ADJUSTABLE PEDALS To help drivers of varying sizes sit at a comfortable distance from the steering wheel, adjustable pedals with memory are available in SLT and SLE models, and are standard in Denali.

POWER FRONT SEATING Get comfortable more easily with power-adjustable front seats. Power driver seat adjustment is available for 40/20/40 seating with select equipment packages, and power driver and passenger seats are included with all bucket seats in SLE (6-way), SLT (10-way) and Denali (12-way).

REMOTE VEHICLE START This available feature lets you start your vehicle from up to 195 feet away. Your Sierra will run for up to 10 minutes. If equipped with the automatic climate control system, it will default to heating or cooling mode based on the outside temperature.

REAR-VISION CAMERA SYSTEM Make it easier to back up to a trailer or negotiate a tight space. This available system places a monitor in your rearview mirror (or navigation screen, if equipped) to display a view of the area behind the vehicle. The rear-vision camera does not replace driver vision. Please use proper care when backing up.

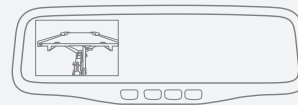

STEERING-WHEEL-MOUNTED RADIO CONTROLS Play your audio system with your fingertips, while you keep your eyes on the road. These available fingertip controls can also manage most music search features of compatible MP3 and iPod® players, as well as Bluetooth¹ for phone.

ULTRASONIC REAR PARKING ASSIST This available system sends out ultrasonic waves that act like rear bumper radar to alert you to the distance of objects up to 8 feet behind the vehicle. The system operates at speeds less than 5 mph. The closer you are, the faster it beeps, to give you a clear signal that can help you operate the vehicle with maximum care.

UNIVERSAL HOME REMOTE Never get locked out again. This available remote can be easily programmed to operate the majority of garage-door-opening systems, and has the benefit of never needing batteries.

ENTERTAINMENT

BOSE® AUDIO SYSTEMS Make the front seat of your Sierra sound like the front row of your favorite concert. Bose systems are engineered to give you the realism and presence of a live performance. Standard on SLT and available on SLE models, Bose Audio features steering-wheel-mounted radio controls and a premium speaker system, with a center console-mounted woofer for rich bass tones that give you a fuller listening experience.

BOSE CENTERPOINT® SOUND For the sensation of a live performance while you drive, Denali models have standard Bose Centerpoint surround-sound system with SurroundStage® signal processing. This technology, along with AudioPilot® noise compensation, wraps you in sound, delivering five independent channels from existing two-channel recordings.

DEALER-INSTALLED WI-FI² Connect up to 20 wireless users at one time and stay in touch with your life's vital information with the first wireless router designed just for automotive use. Ask your dealer for specific plans and prices for this available system.

MP3 PLAYBACK CAPABILITY Bring the music and entertainment you love to your Sierra just by plugging in this available playback cable. Accommodates most MP3 players and devices, including iPod® and many smartphones.

REAR-SEAT ENTERTAINMENT SYSTEM Let your rear-seat passengers enjoy the ride in your Sierra even more. Available in SLT and Denali Crew Cab models, this system includes a DVD player and 8" flip-down screen. It also comes with dual-play, which has a separate upper DVD slot in the radio to let front-seat passengers control the DVD or music playing behind them. The system is compatible with most popular video gaming systems.

SiriusXM SATELLITE RADIO³/NAVTRAFFIC⁴ Enjoy SiriusXM Satellite Radio in your Sierra with a 3-month trial subscription to the XMPremier Package. Only SiriusXM brings you more of what you love, all in one place. Get over 130 channels, including commercial-free music, plus the best sports, news, talk, comedy and entertainment. With NavTraffic⁴, you'll get continuously updated traffic information as it occurs, right on your vehicle's available navigation system. Welcome to the world of SiriusXM. (Available on WT models.)

TOUCH-SCREEN NAVIGATION SYSTEM⁵ For easy operation, the available system includes a large 7" in-dash touch-screen display, 2-D or 3-D map graphics and 3 months of NavTraffic.⁴ OnStar subscribers can also use this system with OnStar Turn-by-Turn Navigation assistance. For your convenience, this screen also serves as a large, easily read monitor for the available Rear-Vision Camera System. Its sophisticated new features include pause-and-play capability for live broadcasts that works like a DVR for your vehicle, a built-in hard drive, an available XMWeather subscription and improved display resolution for enhanced visibility and viewing.

¹Go to gm.com/bluetooth to find out which Bluetooth phones are compatible with the vehicle. ²Monthly rates apply. Visit autonetmobile.com for coverage map and details. ³Requires a subscription, sold separately by SiriusXM after the trial period. SiriusXM Radio service only available in the 48 contiguous United States and the District of Columbia. For more information and to view Customer Agreement, visit siriusxm.com. ⁴NavTraffic requires a monthly subscription after introductory trial service, sold separately by SiriusXM. NavTraffic only available in select markets. For more information, visit siriusxm.com/navtraffic. ⁵Map coverage for Puerto Rico and the U.S. Virgin Islands available on separate disc. Coverage not available for portions of Canada.

USB CONNECTIVITY⁶ Make your Sierra a powerful MP3 device. Plug into the available USB port, and you can control most of your Android™-based, iPod® or MP3 music player's functions, including playlists and song selection from your convenient steering-wheel-mounted radio controls.

DIRECTIONS & CONNECTIONS

DIRECTIONS & CONNECTIONS PLAN⁷ Success in today's fast-moving world means finding and focusing on the information that means the most to you. To put this capability at your fingertips, Sierra comes standard with a 6-month trial subscription to the OnStar Directions & Connections Plan. (Available on WT models.)

HANDS-FREE CALLING WITH VOICE-ACTIVATED DIALING Available OnStar Hands-Free Calling is built into your Sierra. Just push a button, call out the number and you're free to keep your eyes on the road. It's reliable, because it is specially designed for better connectivity and fewer dropped calls in areas with limited cellular reception.

TURN-BY-TURN NAVIGATION Drive with more confidence and certainty. OnStar Turn-By-Turn Navigation is built into OnStar-equipped Sierra models. It's simple—all you have to do is push one button and ask the OnStar Advisor to download directions to your vehicle. Turn-By-Turn is also smart, because an automated voice calls out every turn as you need it.

ONSTAR eNAV WITH GOOGLE™ MAPS AND ONSTAR eNAV WITH MAPQUEST.COM™ Want to get a head start on a trip? Start by checking out your destination on Google Maps or mapquest.com. With OnStar eNav, just click the "Send" link on the Web site, and it will be sent to your vehicle. When you're ready to head out, simply retrieve the destination and directions will be downloaded to your vehicle based on your location, with nothing to type on the screen and no maps to hold.

DESTINATION DOWNLOAD Looking for a destination in your screen-based navigation system? OnStar will do it for you. Simply press your blue OnStar button, and you will be connected with a trained Advisor who will download your directions to your Sierra's available screen-based navigation system. You can also have destinations downloaded on the go—no need to pull over to enter new addresses. It's an enhancement to navigation that makes screen-based navigation systems easier and faster to use.

VEHICLE SECURITY

STOLEN VEHICLE ASSISTANCE If your Sierra is ever stolen, OnStar can help locate it after verification with law enforcement. OnStar can use built-in GPS technology to help to locate it, prevent it from restarting with Remote Ignition Block or, if the vehicle is in use, engage the Stolen Vehicle Slowdown technology to help police recover it quickly and safely.

ROADSIDE ASSISTANCE⁸ If the unexpected happens on the road—you're stranded, run out of gas or have a flat tire—one push of the OnStar button can immediately connect you to an Advisor, ready to help any hour of the day or night. OnStar can use GPS technology to pinpoint your location and connect you to a service provider. No guessing about where you are or what to do.

REMOTE DOOR UNLOCK It's happened to everyone. But there is an easy solution. If you get locked out of your Sierra, OnStar can help. After verifying your account, an OnStar Advisor can send a signal to your Sierra that usually unlocks the doors within minutes.⁹

DRIVER CONFIDENCE

AUTOMATIC CRASH RESPONSE If your Sierra is in a crash, built-in sensors can automatically send an alert to OnStar. An OnStar Advisor is immediately connected to your vehicle to help you. Even if you aren't capable of responding, the Advisor can use GPS technology to locate you and request that emergency help is sent right away.

CRISIS ASSIST During severe weather or other natural disasters, OnStar can offer assistance and help you navigate your way to safety. Just push the red OnStar emergency button and our specially trained Crisis Assist Team moves quickly to help you. OnStar can pinpoint your location and provide up-to-date information from public safety authorities, request that help be sent to you or even contact family members or loved ones.

EMERGENCY SERVICES If someone in the vehicle needs emergency help, the OnStar emergency button gives you a priority connection to a specially trained Advisor at any time, day or night. OnStar uses GPS technology to pinpoint your location and can request police, fire or medical support be sent right away. The Advisor can also stay with you on the line until help arrives.

ONSTAR REMOTELINK APP The OnStar Remotelink app offers an amazing level of control and connection with your vehicle. After downloading and registering the app, GMC owners with an eligible vehicle can use their iPhone® or Android™-based mobile devices to control their vehicle from their phone and perform specific commands—like unlocking their doors—remotely.⁹ You can lock/unlock your doors from any distance, start your vehicle remotely,¹⁰ sound your horn and flash your lights to help locate your vehicle or contact an OnStar Advisor, Roadside Assistance or your preferred dealer. To learn all about all the great features available, go to onstar.com.

FRONTAL AIR BAGS¹¹ All Sierra models come with driver and front-passenger air bags. To help reduce the risk of injury to passengers, Light Duty models come standard with dual-stage frontal air bags that have sensors to gauge the severity of a crash, then determine whether to deploy one or two levels of inflation. Sierra Light Duty models also feature a Passenger Sensing System for the outboard front passenger that automatically turns off the air bag if the passenger is under the appropriate weight.

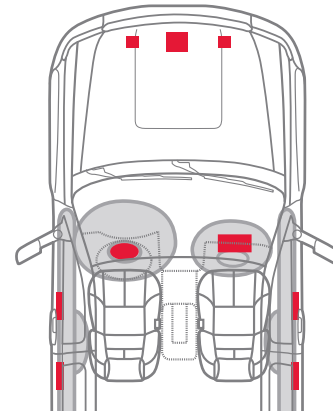

HEAD CURTAIN SIDE-IMPACT AIR BAGS¹¹ These air bags unfurl from the roof rail like a protective curtain for outboard passengers, and can be activated by either rollover sensors or side-impact sensors.

SEAT-MOUNTED SIDE-IMPACT AIR BAGS¹¹ To help protect the thorax and pelvic regions of the driver and outside front passenger in a side-impact collision, Sierra Light Duty and Heavy Duty Denali models include side-impact air bags mounted on the driver and outside front passenger seat. They are available on select Heavy Duty models.

LATCH CHILD SEAT ANCHORING SYSTEM Make it easier to properly install a child seat. LATCH stands for Lower Anchors and Top tethers for Children. A LATCH seat will install to specially designed retainer hooks in your Sierra with an audible "click." It also means that you can install a top tether strap that helps limit movement in a forward crash to help reduce the chance of injury.

REINFORCED STEEL SAFETY CAGE DESIGN Sierra's robust body structure is engineered to help maintain the integrity of the passenger compartment in the event of a collision. All steel from wheel to wheel, the body is designed to crush in a controlled manner in the event of a collision, absorbing the energy of a crash as much as possible.

PASS-KEY III+ THEFT DETERRENT SYSTEM Preventing unauthorized starting attempts in your Sierra comes down to a tiny chip found in your ignition key. It functions as an electronic "fingerprint" that disables your starting system if it detects a theft attempt is underway.

⁶Not compatible with all devices. ⁷Visit onstar.com for coverage map, details and system limitations. OnStar acts as a link to existing emergency service providers. Services vary with conditions. ⁸Roadside service provided by Cross Country. ⁹Requires power door locks. ¹⁰Requires factory-installed remote start. ¹¹Air bag inflation can cause severe injury or death to anyone too close to the air bag when it deploys. Be sure every occupant is properly restrained. Always use safety belts and the correct restraint for your child's age and size. Even in vehicles equipped with the Passenger Sensing System, children are safer when properly secured in a rear seat in the appropriate infant, child or booster seat. Never place a rear-facing infant restraint in the front seat of any vehicle equipped with a passenger air bag. See the Owner's Manual and child safety seat instructions for more safety information.



PART 3
SPEC YOUR MODEL

GMC.COM/EXPLORESIERRA

TRIM LEVELS

WT
SL
SLE
SLT
DENALI

CONFIGURATIONS

	WT	SL	SLE	SLT	DENALI
Regular Cab	•	–	•	–	–
Extended Cab	•	•	•	•	–
Crew Cab	•	•	•	•	•

MECHANICAL SIERRA 1500

ALL-WHEEL DRIVE Electronic automatic system	–	–	–	–	A
ALUMINIZED STAINLESS STEEL EXHAUST	S	S	S	S	S
AUXILIARY EXTERNAL TRANSMISSION OIL COOLER Heavy-duty air-to-oil. On WT models, requires Trailing Package, Snow Plow Prep Package or Heavy-Duty Cooling Package. On SL models, included with Trailing Package. On SLE models, requires Heavy-Duty Trailing Package, Snow Plow Prep Package and 6-speed automatic transmission.	A	A	A	S	S
BATTERY Heavy-duty maintenance-free with 600 cold-cranking amps, rundown protection and retained accessory power	S	S	S	S	S
BRAKES Front disc/rear drum with 4-wheel antilock 4-wheel disc with 4-wheel antilock	S	S	S	S	–
EATON® HEAVY-DUTY AUTOMATIC LOCKING REAR DIFFERENTIAL	A	A	A	S	S
ENGINE Vortec 4.3L V-6 Vortec 4.8L V-8 Variable Valve Timing (VVT) FlexFuel Vortec 5.3L V-8 VVT FlexFuel with Active Fuel Management Vortec 6.2L V-8 VVT FlexFuel	S	–	–	–	–
ENGINE BLOCK HEATER	A	A	A	A	A
EXTERNAL ENGINE OIL COOLER Heavy-duty air-to-oil. Integral to driver side of radiator tank. On WT models, requires Heavy-Duty Trailing Package or Heavy-Duty Cooling Package. On SLE models, requires 6-speed automatic transmission.	A	–	A	S	S
FRAME Fully boxed to the spare tire area, with hydroformed front section	S	S	S	S	S
HEAVY-DUTY COOLING PACKAGE Includes external engine oil cooler, auxiliary external transmission oil cooler, electric fan and heavy-duty radiator. Only available with 6-speed transmission.	A	–	A	S	S
STABILITRAK STABILITY CONTROL SYSTEM With proactive roll avoidance and traction control	S	S	S	S	S
SUSPENSION Coil-over-shock independent front; semi-elliptical 2-stage multileaf springs rear	S	S	S	S	S
HEAVY-DUTY HANDLING/TRAILERING SUSPENSION Requires Heavy-Duty Trailing Package on WT models	A	S	S	S	–
Z71 OFF-ROAD SUSPENSION PACKAGE Includes off-road jounce bumpers, high-capacity air cleaner, Skid Plate Package and Z71 decals on rear quarters	–	–	A	A	–
HIGH-PERFORMANCE SUSPENSION PACKAGE Included with 20" chrome-clad aluminum wheels	–	–	A	A	S
TRANSMISSION 4-speed automatic, electronically controlled 6-speed automatic, electronically controlled Transfer case. On WT and SL models, includes floor-mounted shifter. On SLE and SLT models, includes Autotrac electronic case with rotary dial controls (4WD models).	S	S	S	–	–
TRAILERING Heavy-Duty Trailing Package. Includes trailing hitch platform and 2" receiver, 7-wire harness with independent fused trailing circuits mated to a 7-way sealed connector, wiring harness for aftermarket trailer brake controller (located in the instrument panel harness), single wire for center high-mounted stop lamp, heavy-duty automatic locking rear differential and external transmission oil cooler. On 1500 WT and SLE models equipped with 6-speed transmission, includes Heavy-Duty Cooling Package and external engine oil cooler. Integrated trailer brake controller. Not available with Vortec 4.3L V-6. Requires Heavy-Duty Trailing Package.	A	A	A	S	S
TRAILER SWAY CONTROL With Hill Start Brake Assist. Not available on Sierra Hybrid.	S	S	S	S	S

A-Available S-Standard –-Not Available
SRW-Single Rear Wheel DRW-Dual Rear Wheel

TRIM LEVELS

WT
SL
SLE
SLT
DENALI

MAX TRAILERING PACKAGE Includes Vortec 6.2L V-8, heavy-duty automatic locking rear differential, Heavy-Duty Handling/Trailing Suspension Package, 9.5" hybrid rear axle, 3.73 rear axle ratio, front and rear disc brakes, Heavy-Duty Trailing Package, fog lamps and 17" polished aluminum wheels. Available on Extended and Crew Cab models only.	–	–	A	A	–
POWER TECH PACKAGE Includes Vortec 5.3L V-8 SFI FlexFuel engine, heavy-duty automatic locking rear differential, Heavy-Duty Trailing Package, dual-zone automatic air conditioning, Bluetooth® for phone, steering-wheel-mounted audio controls, CD/MP3 player, driver 6-way power seat adjuster, front fog lamps, EZ-Lift locking tailgate and 17" aluminum wheels. Available on Extended and Crew Cab models only.	–	–	A	–	–
SKID PLATE PACKAGE Frame-mounted shields. Includes front underbody shield starting behind front bumper and running to first cross-member, protecting front underbody, oil pan, differential case and transfer case. Requires 4WD on WT models. Not available on 2WD SLE and SLT models unless Z71 Off-Road Suspension Package is ordered.	A	A	A	A	S
SNOW PLOW PREP PACKAGE Includes 10-amp power for back-up and roof emergency light, 160-amp alternator, high-flow front bumper, forward lamp wiring harness, provision for cab roof-mounted lamp/beacon, instrument panel jumper wiring harness for electronic trailer brake controller, high-capacity air cleaner, auxiliary external transmission oil cooler and Skid Plate Package (4WD Regular Cab models only)	A	–	A	–	–

MECHANICAL SIERRA 2500HD/3500HD

ALTERNATOR 125-amp 160-amp. Included with Snow Plow Prep Package when Vortec 6.0L SFI V-8 is ordered. Requires Vortec 6.0L SFI V-8.	S	–	S	S	S
Dual, 125 amps each. Included with Snow Plow Prep Package when Duramax Diesel 6.6L V-8 Turbo is ordered. Requires Duramax Diesel 6.6L V-8 Turbo engine.	A	–	A	A	A
BATTERY Heavy-duty, maintenance-free with 600 cold-cranking amps, rundown protection and retained accessory power Auxiliary heavy-duty, maintenance-free with 600 cold-cranking amps. Not available with Duramax Diesel 6.6L V-8 Turbo engine.	S	–	S	S	S
Heavy-duty, 2 batteries, maintenance-free with 730 cold-cranking amps, with rundown protection and retained accessory power. Included and only available with Duramax Diesel 6.6L V-8 Turbo engine.	A	–	A	A	A
BRAKES Power 4-wheel disc, 4-wheel antilock	S	–	S	S	S
EATON HEAVY-DUTY AUTOMATIC LOCKING REAR DIFFERENTIAL Included with Heavy-Duty Trailing Package. Standard on all 3500HD pickup models.	A	–	A	S	S
ENGINE Vortec 6.0L V-8 VVT FlexFuel with SFI Duramax Diesel 6.6L V-8 Turbo with direct injection and B20 biodiesel capability	S	–	S	S	S
ENGINE BLOCK HEATER	A	–	A	A	A
ENGINE OIL COOLER Heavy-duty external air-to-oil. Integral to driver side of radiator tank.	S	–	S	S	S
EXHAUST Aluminized stainless steel	S	–	S	S	S
EXHAUST BRAKE Included with Duramax Diesel 6.6L V-8 Turbo engine only	A	–	A	A	A
FRAME Fully boxed with hydroformed front section 10,000-lb GVWR ² package. Select Sierra 3500HD SRW models. See your dealer for details.	S	–	S	S	S
HIGH-CAPACITY AIR CLEANER	S	–	S	S	S
HIGH IDLE SWITCH	A	–	A	A	A
RADIATOR GRILLE AND FRONT BUMPER OPENINGS COVER For cold weather. Requires Duramax Diesel 6.6L V-8 Turbo engine.	A	–	A	A	A
REAR AXLE 3.73 ratio (except 3500HD 2WD Regular Cab SRW model) 4.10 ratio. Requires Vortec 6.0L V-8 engine.	S	–	S	S	S
	A	–	A	A	A

TRIM LEVELS

	WT	SL	SLE	SLT	DENALI
SKID PLATE PACKAGE Frame-mounted shields. Includes front underbody shield starting behind front bumper and running to first cross-member, protecting front underbody, oil pan, differential case and transfer case. Requires 4WD on WT models. Not available on 2WD SLE and SLT models unless Z71 Off-Road Suspension Package is ordered.	A	-	A	A	S
SNOW PLOW PREP PACKAGE Includes 10-amp power for back-up and roof emergency light, 160-amp alternator (dual 125 amp included with Diesel), high-flow front bumper, forward lamp wiring harness, provision for cab roof-mounted lamp/beacon, instrument panel jumper wiring harness for electronic trailer brake controller, Skid Plate Package (4WD models only) and increased Front Gross Axle Weight Rating (FGAWR). See chart on page 37 for more details.	A	-	A	A	A
STABILITRAK Stability control system Includes electronic trailer sway control, Intelligent Brake Assist and Hill Start Assist (SRW models only)	S	-	S	S	S
STEERING Power, recirculating ball	S	-	S	S	S
SUSPENSION Front independent with torsion bar	S	-	S	S	S
Rear multileaf springs, semi-elliptic with urethane jounce bumpers	S	-	S	S	S
HEAVY-DUTY HANDLING/TRAILERING SUSPENSION PACKAGE	S	-	S	S	S
Z71 Off-Road Suspension Package. Includes off-road jounce bumpers, Skid Plate Package and Z71 decals on rear quarters.	-	-	A	A	A
HEAVY-DUTY TRAILERING PACKAGE Includes trailering hitch platform and 2.5" receiver with 2" adapter, 7-wire harness with independent fused trailering circuits mated to a 7-way sealed connector, wiring harness for aftermarket trailer brake controller (located in the instrument panel harness) and integrated trailer brake controller. Standard on all 3500HD models.	A	-	A	S	S
Integrated trailer brake controller. Requires Heavy-Duty Trailering Package. Standard on all 3500HD models.	A	-	A	S	S
Trailering wiring provisions for camper, fifth-wheel and gooseneck trailers; includes additional 8-way wiring harness routed to front of pickup box. Requires Heavy-Duty Trailering Package.	A	-	A	A	A
TRAILER SWAY CONTROL SRW models only	S	-	S	S	S
TRANSFER CASE With floor-mounted shifter (4WD models)	S	-	-	-	-
Electronic shift with rotary dial controls (4WD models)	-	-	S	S	S
TRANSMISSIONS 6L90-E 6-speed automatic. Standard and only available with Vortec 6.0L V-8.	S	-	S	S	S
Allison 1000 Series 6-speed automatic. Included and only available with Duramax Diesel 6.6L V-8 Turbo.	A	-	A	A	A
TRANSMISSION OIL COOLER Auxiliary external heavy-duty air-to-oil	S	-	S	S	S

SEATING – ALL MODELS

SEATS 40/20/40 front split-bench with driver and front-passenger manual recline and center fold-down armrest with storage	S	S	-	-	-
40/20/40 front split-bench with driver and front-passenger manual recline. Center fold-down armrest and lockable storage compartment in seat cushion (includes auxiliary power outlet). Adjustable outboard head restraints on Extended and Crew Cab models.	-	-	S	-	-
Front buckets with 6-way power seat adjusters, manual recline, manual lumbar and adjustable head restraints. Requires Extended or Crew Cab models.	-	-	A	-	-
Front buckets with 10-way power seat adjusters (SLT) or 12-way (Denali) including power lumbar control, heated seat cushions and seatbacks, 2-position driver memory (does not apply to lumbar adjuster on SLT) and adjustable head restraints. Includes floor console and storage pockets.	-	-	-	S	S
Heated and cooled perforated leather-appointed seating with 12-way seat adjuster for driver and front passenger. Includes seat-mounted side-impact air bags ³ on SLT and Denali HD SRW models.	-	-	-	A	S
Driver-side manual seat adjuster with lumbar control. On WT models, included and only available with Dark Titanium Cloth seat trim.	A	S	S	-	-
Folding rear bench, full width. Extended Cab models only.	S	S	-	-	-

TRIM LEVELS

	WT	SL	SLE	SLT	DENALI
60/40 folding rear bench. WT and SL require Crew Cab models. SLE requires Extended or Crew Cab models. Not available on Sierra Hybrid.	S	S	S	S	S
SEAT TRIM Dark Titanium vinyl with Graphite-colored rubberized vinyl floor covering	S	-	-	-	-
Dark Titanium Cloth	A	S	-	-	-
Premium Cloth	-	-	S	-	-
Front leather-appointed seating. Includes 6-way power driver seat adjuster. Not available on Regular Cab models.	-	-	A	S	-
Premium front leather-appointed seating, Nuance	-	-	-	-	S

INSTRUMENTATION AND CONTROLS – ALL MODELS

CRUISE CONTROL	S	S	S	S	S
INSTRUMENTATION Analog cluster with speedometer, fuel level, engine temperature and tachometer. On SLE, SLT and Denali models, includes voltmeter and oil pressure indicators.	S	S	S	S	S
Driver Information Center with odometer, trip odometer and message center. On SLE, SLT and Denali models, includes compass and outside temperature.	S	S	S	S	S
POWER-ADJUSTABLE PEDALS Requires Convenience Package	-	-	A	A	S
REAR-VISION CAMERA SYSTEM With inside rearview mirror display; if Touch-Screen Navigation is ordered, camera display is on NAV screen. Requires Convenience Package. On SLE models, also requires SLE Preferred Package.	-	-	A	A	S
STEERING WHEEL Tilt-Wheel adjustable steering column with brake/transmission shift interlock	S	S	S	S	S
Leather-wrapped (color-keyed on Denali). On WT and SL models, requires Bluetooth ¹	A	A	S	S	S
Steering-wheel-mounted audio controls. On WT and SL models, requires Bluetooth ¹ On SLE models, requires Preferred Package.	A	A	A	S	S
Heated, leather-wrapped and color-keyed	-	-	-	-	S
ULTRASONIC REAR PARKING ASSIST With audible warning. Requires Extended or Crew Cab models. Requires Convenience Package.	-	-	A	A	S

INTERIOR DETAILS – ALL MODELS

CARPETING Color-keyed with rubberized vinyl floor mats. Extended and Crew Cab models also include rear floor mats; WT models require Dark Titanium Cloth seat trim.	A	S	S	S	-
Color-keyed with removable carpeted floor mats for first and second rows	-	-	-	-	S
CLIMATE CONTROL Single-zone manual air conditioning	S	S	S	-	-
Dual-zone automatic air conditioning with individual settings for driver and right-front passenger; not available with Regular Cab models. Requires Preferred Package.	-	-	A	S	S
DEFOGGER Rear window. Not available with power-sliding rear window.	A	A	A	S	S
FLOOR COVERING Rubberized vinyl	S	A	A	-	-
REARVIEW MIRROR With manual day/night adjustment	S	S	S	-	-
Auto-dimming. Standard on SLE 3500HD models.	-	-	A	S	S
SUNROOF Power with express-open. Includes Universal Home Remote. Extended and Crew Cab models only.	-	-	-	A	A
WINDOWS Power with driver express-down. SLT and Denali models include front passenger express-down.	-	S	S	S	S
Rear-access-door, power. Requires Extended Cab models.	-	-	S	S	-
Rear, power-sliding. Not available on Regular Cab models or with rear-window defogger.	-	-	A	A	A

¹Go to gm.com/bluetooth to find out which Bluetooth phones are compatible with the vehicle. ²When properly equipped; includes weight of vehicle, passengers, cargo and equipment. ³Always use safety belts and the correct restraint for your child's age and size. Even in vehicles equipped with the Passenger Sensing System, children are safer when properly secured in a rear seat in the appropriate infant, child or booster seat. Never place a rear-facing infant restraint in the front seat of any vehicle equipped with a passenger air bag. See the Owner's Manual and child safety seat instructions for more safety information.

TRIM LEVELS	WT	SL	SLE	SLT	DENALI
-------------	----	----	-----	-----	--------

OPTION PACKAGES – SIERRA 1500

WORK TRUCK PREFERRED PACKAGE Includes power door locks, remote keyless entry, EZ-Lift locking tailgate and Solar-Ray deep-tinted glass. Requires Regular or Extended Cab models.	A	-	-	-	-
WORK TRUCK PLUS PACKAGE Includes 17" chrome-styled steel wheels, chrome surround grille and fog lamps. Requires 1500 Regular or Extended Cab models. On 2WD models, also includes front frame-mounted recovery hooks.	A	-	-	-	-
SLE CONVENIENCE PACKAGE Includes power-adjustable pedals, Universal Home Remote, remote vehicle starter system, Ultrasonic Rear Parking Assist and rear-window defogger. Requires Extended or Crew Cab models.	-	-	A	-	-
SLE PREFERRED PACKAGE (REGULAR CAB) Includes remote vehicle starter system, steering-wheel-mounted controls, Bluetooth ¹ for your cell phone, CD/MP3 player, fog lamps, EZ-Lift locking tailgate and 17" polished aluminum wheels	-	-	A	-	-
SLE PREFERRED PACKAGE (EXTENDED OR CREW CAB) Includes steering-wheel-mounted controls, dual-zone automatic air conditioning, 6-way power driver seat adjuster, Bluetooth ¹ for your cell phone, CD/MP3 player, fog lamps and EZ-Lift locking tailgate	-	-	A	-	-
ALL-TERRAIN PACKAGE Includes Z71 Off-Road Suspension Package, Heavy-Duty Trailering Package, inside rearview auto-dimming mirror, 18" x 8" chrome-clad aluminum wheels, P265/65R18 on-/off-road blackwall tires, outside heated power-adjustable power-folding body-colored mirrors, fog lamps, Rancho [®] brand shocks, body-colored side moldings with chrome accents, unique 4-bar horizontal grille insert with chrome surround, "All Terrain" badging on the front fenders, carpeted floor mats with embroidered "All Terrain" logo, unique sill plates, unique instrument cluster with Z71 logo and mechanical brushed aluminum accents for instrument panel, center console and switch trim plates. Requires Extended or Crew Cab models.	-	-	A	A	-
BODY-COLOR ALL-TERRAIN PACKAGE Includes All-Terrain Package content, plus body-color 4-bar horizontal grille and surround, body-color door handles, mirror caps, front and rear painted bumpers and 20" chrome-clad wheels (S86). ² Requires Extended or Crew Cab models.	-	-	A	A	-
CHROME ESSENTIALS PACKAGE Includes 6" chromed tubular oval assist steps, polished exhaust tip, chrome recovery hooks, chrome door handles and mirror caps and 18" chrome-clad aluminum wheels. Not available on Long Box Extended Cab models.	-	-	A	A	-

OPTION PACKAGES – SIERRA 2500HD/3500HD

WORK TRUCK PREFERRED PACKAGE Includes Solar-Ray deep-tinted glass and fog lamps. On 2500HD models, includes 17" chrome-clad steel wheels.	A	-	-	-	-
SLE PREFERRED PACKAGE (REGULAR CAB) Includes remote vehicle starter system, steering-wheel-mounted controls, Bluetooth ¹ for your cell phone, CD/MP3 player, fog lamps and EZ-Lift locking tailgate	-	-	A	-	-
SLE PREFERRED PACKAGE (EXTENDED OR CREW CAB) Includes steering-wheel-mounted controls, dual-zone automatic air conditioning, 6-way power driver seat adjuster, Bluetooth ¹ for your cell phone, CD/MP3 player, fog lamps and EZ-Lift locking tailgate	-	-	A	-	-
SLE CONVENIENCE PACKAGE Includes power-adjustable pedals, Universal Home Remote, remote vehicle starter system, rear-window defogger and Ultrasonic Rear Parking Assist	-	-	A	-	-
SLT CONVENIENCE PACKAGE Includes Universal Home Remote, power-adjustable pedals, EZ-Lift locking tailgate, Ultrasonic Rear Parking Assist and rear wheelhouse liner (dealer installed)	-	-	-	A	-

TRIM LEVELS	WT	SL	SLE	SLT	DENALI
-------------	----	----	-----	-----	--------

ENTERTAINMENT/COMMUNICATION/NAVIGATION – ALL MODELS

AM/FM STEREO With seek-and-scan and digital clock	S	-	-	-	-
With MP3-compatible CD player	A	S	S	-	-
With CD player and MP3 playback, USB port ³ and auxiliary input jack. On SLE models, requires SLE Preferred Package.	-	-	A	S	-
With MP3-compatible 6-disc CD player, USB port ³ and auxiliary input jack	-	-	-	A	S
With MP3-compatible CD/DVD player and USB port. ³ On SLT models, requires Crew Cab model and Rear-Seat Entertainment Package. On Denali models, requires Rear-Seat Entertainment Package.	-	-	-	A	A
TOUCH-SCREEN NAVIGATION⁴ With CD or DVD player and MP3 playback, color touch-screen display, enhanced HDD-based navigation with voice recognition, memory available for music storage, USB port. ³ Radio Data System (RDS) ⁵ and pause/play radio. Touch-Screen Navigation with DVD player requires Rear-Seat Entertainment Package.	-	-	-	A	A
BOSE[®] AUDIO PREMIUM SPEAKER SYSTEM WITH SUBWOOFER On SLE models, requires front bucket seats and SLE Preferred Package or Power Tech Package on 1500 models	-	-	A	S	S
Centerpoint [®] Surround Sound System	-	-	-	-	S
REAR-SEAT ENTERTAINMENT PACKAGE Rear-seat DVD player with LCD display and 2 sets of wireless headphones. Includes rear audio controls. Requires Crew Cab models. On SLT models, includes CD/DVD player. Upgradable to CD/DVD player with navigation. On Denali models, requires CD/DVD player or CD/DVD player and HDD-based navigation.	-	-	-	A	A
SiriusXM SATELLITE RADIO⁶ Including 3 trial months of service	A	S	S	S	S
NAVTRAFFIC⁷ Including 3 trial months of service. Included and only available with Touch-Screen Navigation. ⁴	-	-	-	A	A
BLUETOOTH FOR PHONE¹ Personal cell-phone connectivity to vehicle audio system allowing hands-free calling	A	A	A	S	S
ONSTAR Directions & Connections Plan.⁸ 6-month subscription.	A	S	S	S	S

CONVENIENCE FEATURES – ALL MODELS

POWER DOOR LOCKS With remote keyless entry (2 transmitters, panic button and content theft alarm). Remote keyless entry does not lock/unlock tailgate. Standard on Crew Cab models.	A	S	S	S	S
REMOTE START With remote keyless entry	-	-	A	S	S
UNIVERSAL HOME REMOTE	-	-	A	A	S

EXTERIOR STYLING AND FUNCTIONALITY – ALL MODELS

BODYSIDE MOLDINGS Body-colored. Chrome insert on Denali models. Not available on Regular Cab DRW models.	-	S	S	S	S
BUMPERS Chrome. On Sierra 1500 WT models, includes black bumper top caps. On SL, SLE and SLT models, includes body-color bumper top caps.	S	S	S	S	-
Front, body-colored	-	-	-	-	S
Rear, chrome step-style with pad	S	S	S	S	-
Rear, body-colored step-style with pad	-	-	-	-	S
DOOR HANDLES Chrome	-	-	-	-	S
EZ-LIFT LOCKING TAILGATE	A	A	A	A	S
FRONT LICENSE PLATE BRACKET Included in all states that require a front license plate	A	A	A	A	A
GLASS Solar-Ray deep tinted	A	S	S	S	S
GRILLE SURROUND Black. 1500 WT models only.	S	-	-	-	-
Chrome grille surround with black horizontal bars. 2500HD and 3500HD WT models only.	S	-	-	-	-

A-Available S-Standard --Not Available
SRW-Single Rear Wheel DRW-Dual Rear Wheel

TRIM LEVELS

	WT	SL	SLE	SLT	DENALI
Chrome grille surround with chrome horizontal bars (on non-Denali HD models late availability). On WT models, requires Work Truck Plus Package. On Denali models, includes unique chrome upper and lower.	A	S	S	S	S
LIGHTS Halogen front fog lamps. On WT and SLE models, requires Preferred Package.	A	-	A	S	S
Dual cargo area lamps	S	S	S	S	S
WIPERS Wet-arm front intermittent	S	S	S	S	S
RECOVERY HOOKS Front, frame-mounted; standard on 1500 4WD and Denali models. Standard on HD models. Requires All-Terrain Package on 2WD 1500 models.	S	S	S	S	S
Chrome (1500 models only). Requires Chrome Essentials Package.	-	-	A	A	-
TIRE CARRIER Outside spare, winch-type	S	S	S	S	S

OUTSIDE MIRRORS – ALL MODELS

Manual-folding, black (1500 and 2500HD models)	S	-	-	-	-
Heated power-adjustable, manual-folding, black (1500 and 2500HD models only)	A	S	S	-	-
Heated power-adjustable/power-folding. With integrated turn signal indicators and driver-side auto-dimming; body-color. Not available on 2500HD SLE models. On Light Duty SLE models, requires All-Terrain Package.	-	-	A	S	S
VERTICAL CAMPER Manual-folding with lower convex spotter glass. Standard on 3500HD models. Available on 1500 and 2500HD models.	A	-	-	-	-
Heated, power-adjustable with integrated turn signal indicators; manual-folding/extension; black (convex glass is not heated or power adjustable). SLE 1500 and 2500HD models require inside rearview auto-dimming mirror or inside rearview auto-dimming mirror with camera display. Standard on 3500HD SLE, SLT and Denali models. Not available on Denali 1500 models.	-	-	A	A	A

SAFETY – ALL MODELS

AIR BAGS ⁹ Frontal. On 1500 models, standard with Passenger Sensing System. On 2500HD and 3500HD models, standard with front driver and passenger single-stage air bag.	S	S	S	S	S
Head curtain, front and rear, side-impact					
1500 models	S	S	S	S	S
2500HD models	A	-	A	A	S
3500HD models (SRW only)	A	-	A	A	S
Seat-mounted, thorax and pelvic, side-impact for driver and outboard front-passenger					
1500 models	S	S	S	S	S
2500HD models	A	-	A	A	S
3500HD models (SRW only)	A	-	A	A	S
TIRE PRESSURE MONITORING SYSTEM (Does not monitor spare tire.) Standard on 3500HD models with GVWR ¹⁰ less than 10,000 lbs.	S	S	S	S	S
DAYTIME RUNNING LAMPS With automatic lamp control	S	S	S	S	S

SIERRA 1500 XFE FEATURES AND SPECIFICATIONS

Includes SLE standard content with the following changes / requirements:

ALUMINUM BLOCK Vortec 5.3L V-8 VVT FlexFuel
AUTOMATIC TRANSMISSION 6-speed with heavy-duty cooling
REAR AXLE 3.08 ratio
ALUMINUM WHEELS N88 17"
LOW ROLLING-RESISTANCE TIRES
ALUMINUM LOWER CONTROL ARMS AND SPARE WHEEL
TONNEAU COVER Soft
EXTENDED AIR DAM AND OTHER AERO IMPROVEMENTS
EATON HEAVY-DUTY AUTOMATIC LOCKING REAR DIFFERENTIAL
HEAVY-DUTY TRAILERING PACKAGE

FUEL ECONOMY

EPA-estimated mpg	15 city / 22 hwy
Max. Trailering ¹¹	7000 lbs
Max. Payload ¹²	1648 lbs
GVWR ¹⁰	6700 lbs
GCWR ¹³	12,200 lbs

MOST SLE CREW CAB OPTIONS ARE AVAILABLE ON THE SIERRA XFE EXCEPT FOR:

20" WHEELS
ALL-TERRAIN PACKAGE
MAX TRAILERING PACKAGE
Z71 OFF-ROAD SUSPENSION PACKAGE
POWER TECH EDITION

¹Go to gm.com/bluetooth to find out which Bluetooth phones are compatible with the vehicle. ²Use only GM-approved tire and wheel combinations. For approved tire and wheel combinations and other important information, go to gmaccessorieszone.com or see your dealer for details. ³Not compatible with all devices. ⁴Map coverage for Puerto Rico and the U.S. Virgin Islands available on separate disc. Coverage not available for portions of Canada. ⁵RDS functions only where stations broadcast RDS information. ⁶Requires a subscription, sold separately by SiriusXM after introductory trial period. SiriusXM service only available in 48 contiguous United States and the District of Columbia. For more information and to view Customer Agreement, visit siriusxm.com. ⁷NavTraffic requires a monthly subscription after introductory trial service, sold separately by SiriusXM. NavTraffic only available in select markets. For more information, visit siriusxm.com/navtraffic. ⁸Visit onstar.com for details and system limitations. ⁹Always use safety belts and the correct restraint for your child's age and size. Even in vehicles equipped with the Passenger Sensing System, children are safer when properly secured in a rear seat in the appropriate infant, child or booster seat. Never place a rear-facing infant restraint in the front seat of any vehicle equipped with a passenger air bag. See the Owner's Manual and child safety seat instructions for more safety information. ¹⁰When properly equipped; includes weight of vehicle, passengers, cargo and equipment. ¹¹Maximum trailer weight ratings are calculated assuming a base vehicle, except for any option(s) necessary to achieve the rating, plus driver. The weight of other optional equipment, passengers and cargo will reduce the maximum trailer weight your vehicle can tow. See your GMC dealer for additional details. ¹²Maximum payload capacity includes weight of driver, passengers, optional equipment and cargo. ¹³When properly equipped, includes weight of the vehicle and trailer combination, including the weight of driver, passengers, fuel, optional equipment and cargo in the vehicle and trailer.

PART 3
SPEC YOUR MODEL (CONTINUED)

SIERRA HYBRID FEATURES AND SPECIFICATIONS/SIERRA 1500 SUSPENSIONS

TRIM LEVELS	3HA	3HB
-------------	-----	-----

SIERRA 1500 HYBRID MECHANICAL

VORTEC 6.0L V-8 VVT HYBRID With Active Fuel Management, hybrid 2-mode Electronically Variable Transmission and 300-volt DC battery pack	S	S
AUXILIARY POWER MODULE To convert 300-volt battery power to 12-volt	S	S
HYBRID-SPECIFIC COOLING DESIGN Includes a separate powertrain electronics coolant circuit to keep the high-voltage hybrid content cool	S	S
COMBINATION TRANSMISSION COOLER Increases transmission cooling capacity	S	S
EATON HEAVY-DUTY AUTOMATIC LOCKING REAR DIFFERENTIAL	S	S
3.08 AXLE RATIO For optimum highway fuel economy	S	S
HEAVY-DUTY TRAILERING EQUIPMENT	S	S
4-WHEEL DISC BRAKES With 4-wheel Antilock Brake System (ABS) and StabiliTrak	S	S
REGENERATIVE BRAKING SYSTEM Uses hybrid motors in the transmission acting as generators to decelerate the vehicle, while capturing energy for the 300-volt battery pack	S	S
ELECTRIC POWER RACK-AND-PINION STEERING For improved fuel economy and on-center feel	S	S

EXTERIOR

EZ-LIFT LOCKING TAILGATE	S	S
18" CHROME-CLAD ALUMINUM WHEELS	S	S
MIRRORS Outside heated power-adjustable, black, manual-folding	S	-
Outside heated power-adjustable, power-folding and driver-side auto-dimming, body-color, with integrated turn-signal indicators	-	S
FOG LAMPS	-	S
REAR-WINDOW DEFROSTER	-	S
POWER SUNROOF	-	A
TONNEAU COVER 1-piece soft cover	S	-
3-PIECE HARD COVER	-	S
ULTRASONIC REAR PARKING ASSIST	-	S

INTERIOR

40/20/40 SPLIT-BENCH FRONT SEATS Premium Cloth with manual recline with outboard head restraints and center fold-down armrest with storage	S	-
LEATHER-APPOINTED FRONT BUCKET SEATS With driver and passenger 6-way power adjusters	-	S
FOLDING REAR BENCH 3-passenger, full width	S	S
AUTO-DIMMING INSIDE REARVIEW MIRROR	-	S
POWER-ADJUSTABLE PEDALS	-	S
UNIQUE HVAC SYSTEM Features a 300-volt electric air conditioning compressor and electric heater coolant pump. Compressor and pump use no belts, operate even when engine is in Autostop and operate as needed.	S	S
SPECIALLY DESIGNED INSTRUMENTATION Features Autostop / Off indicators and economy gauge	S	S
DRIVER INFORMATION CENTER Includes messages for Hybrid System status	S	S
BOSE AUDIO AND REAR-SEAT AUDIO	-	S
TOUCH-SCREEN NAVIGATION¹ With unique hybrid power flow display	-	S
BATTERY BEAUTY COVER Provides a flat load floor and inhibits access to the battery	S	S
DUAL-ZONE AUTOMATIC AIR CONDITIONING	S	S
BLUETOOTH FOR PHONE²	S	S
REAR-VISION CAMERA SYSTEM	-	S

A-Available S-Standard --Not Available
See dealer for availability, inclusions and exclusions.

TRIM LEVELS	3HA	3HB
-------------	-----	-----

SAFETY

AIR BAGS³ Frontal, includes Passenger Sensing System	S	S
Head curtain, front and rear, side-impact with rollover sensor	S	S
Seat-mounted, thorax and pelvic, side-impact for driver and outboard front-passenger	S	S
DAYTIME RUNNING LAMPS With automatic lamp control	S	S
TIRE PRESSURE MONITORING SYSTEM (Does not monitor spare tire)	S	S

ENGINE SPECIFICATIONS

VORTEC 6.0L V-8 VVT HYBRID		
HP @ RPM		332 @ 5100
LB-FT TORQUE @ RPM		367 @ 4100
ACTIVE FUEL MANAGEMENT		

TRAILER RATING⁴

2WD	6100 lbs
4WD	5900 lbs

MAX. PAYLOAD RATINGS⁵

2WD	1527 lbs
4WD	1509 lbs

FUEL ECONOMY

2WD (EPA-est. mpg)	20 city / 23 hwy
4WD (EPA-est. mpg)	20 city / 23 hwy

SIERRA 1500 SPECIFICATIONS

FRONT SUSPENSION⁶ COIL-OVER-SHOCK

FRONT AXLE CAPACITY (Short/Standard/Long Box)	2WD	4WD (Denali: AWD)
Regular Cab (lbs)	- / 3200 / 3300	- / 3950 / 3950
Extended Cab (lbs)	- / 3600 / 3700	- / 3950 / 3950
Crew Cab (lbs)	3650 / - / -	3950 / - / -
Crew Cab: Denali (lbs)	3950 / - / -	3950 / - / -
FRONT SPRING CAPACITY		
Regular Cab (lbs)	- / 3200 / 3300	- / 3950 / 3950
Extended Cab (lbs)	- / 3600 / 3700	- / 3950 / 3950
Crew Cab (lbs)	3650 / - / -	3950 / - / -
Crew Cab: Denali (lbs)	3950 / - / -	3950 / - / -

REAR SUSPENSION⁶ SEMI-ELLIPTICAL 2-STAGE MULTILEAF SPRINGS

REAR AXLE CAPACITY (Short/Standard/Long Box)	2WD	4WD (Denali: AWD)
Regular Cab (lbs)	- / 3750 / 3750	- / 3750 / 3950
Extended Cab (lbs)	- / 3750 / 3950	- / 3950 / 3950
Extended Cab with Max Trailing Package (lbs)	- / 4200 / -	- / 4200 / -
Crew Cab (lbs)	3950 / - / -	4000 / - / -
Crew Cab: Denali (lbs)	4000 / - / -	4000 / - / -
REAR SPRING CAPACITY		
Regular Cab (lbs)	- / 3750 / 3750	- / 3750 / 4000
Extended Cab (lbs)	- / 3750 / 3950	- / 3950 / 3950
Crew Cab (lbs)	3950 / - / -	3950 / - / -
Crew Cab with Max Trailing Package (lbs)	4200 / - / -	4200 / - / -
Crew Cab: Denali (lbs)	3950 / - / -	3950 / - / -

SIERRA 1500 SPECIFICATIONS/SIERRA HEAVY DUTY AXLE RATINGS

ENGINES

	VORTEC 4.3L V-6 (LU3)	VORTEC 4.8L V-8 VVT FlexFuel (L20)	VORTEC 5.3L V-8 VVT AFM / FlexFuel Iron Block (LMG)	VORTEC 5.3L V-8 VVT AFM / FlexFuel Alum Block (LC9)	VORTEC 6.2L V-8 VVT FlexFuel (L9H)
CAPACITY	4.3 liters (262 cu. in.)	4.8 liters (293 cu. in.)	5.3 liters (325 cu. in.)	5.3 liters (325 cu. in.)	6.2 liters (376 cu. in.)
SAE NET HORSEPOWER @ RPM	195@4600	302@5600	326@5300 100% E85 315@5200 gasoline or gasoline / E85 mix	326@5300 100% E85 315@5200 gasoline or gasoline / E85 mix	403@5700
SAE NET TORQUE @ RPM (LB-FT)	260@2800	305@4600	348@4400 100% E85 335@4000 gasoline or gasoline / E85 mix	348@4400 100% E85 335@4000 gasoline or gasoline / E85 mix	417@4300
ENGINE / MODEL AVAILABILITY					
Regular Cab, Standard Box	S	A	A	-	-
Regular Cab, Long Box	S	A	A	-	-
Extended Cab, Standard Box	S [2WD]	S [4WD]	A [2WD]	A [4WD]	-
Extended Cab, Long Box	-	-	S	-	-
Crew Cab, Short Box	-	S	A [2WD]	A [4WD] / S on XFE	A
Crew Cab, Short Box (Denali)	-	-	-	-	S
FUEL ECONOMY (city/hwy mpg)					
2WD	15/20	14/19	15/21	15/21 (15/22 XFE)	13/18
4WD	14/18	13/18	15/21	15/21	12/18

TRANSMISSIONS: 1500: Electronic 4-speed automatic with overdrive and Tow / Haul mode is standard on 4.3L V-6 and 4.8L V-8. Electronically controlled 6-speed automatic transmission with overdrive and Tow / Haul mode included and only available on 5.3L V-8 and 6.2L V-8. Denali: Electronically controlled 6-speed automatic transmission with overdrive and Tow / Haul mode.

CARGO DIMENSIONS ⁷	SHORT BOX	STANDARD BOX	LONG BOX	MAXIMUM PAYLOAD ⁵		MAXIMUM CONVENTIONAL TRAILERING ⁴	
				SELECT RATINGS All capacities in lbs			
				2WD / 4WD		2WD	4WD (Denali: AWD)
Cargo Volume	53.2 cu. ft.	60.7 cu. ft.	75.5 cu. ft.				
Inside Width at Floor	62.4"	62.4"	62.4"	Regular Cab Standard Box	1940/1714	Regular Cab Standard Box	9100 with 5.3L / 3.42 axle
Box Length at Floor	69.3"	78.9"	97.8"	Regular Cab Long Box	1804/1827	Regular Cab Long Box	10,000 with 5.3L / 3.42 axle
EXTERIOR DIMENSIONS	REGULAR CAB	EXTENDED CAB	CREW CAB	Extended Cab Standard Box	1908/1835	Extended Cab Standard Box	10,700 with 6.2L / 3.73 axle
				Extended Cab Long Box	1641/1513	Extended Cab Long Box	9500 with 5.3L / 3.42 axle
Height	73.5"-73.8"	73.6"-73.9"	73.7"-73.8"	Crew Cab: 1500	1937/1890	Crew Cab: 1500	10,600 with 6.2L / 3.73 axle
Overall Length				Crew Cab: 1500 XFE	1648/-	Crew Cab: 1500 XFE	7000 with 5.3L / 3.08 axle
Short Box	-	-	230.2"	Crew Cab: Denali	1589/1623	Crew Cab: Denali	9800 with 6.2L / 3.42 axle
Standard Box	205.6"	230.2"	-	Hybrid	1527/1509	Hybrid	6100 with 6.0L / 3.08 axle
Long Box	224.5"	249.2"	-				5900 with 6.0L / 3.08 axle

HEAVY-DUTY FRONT GROSS AXLE WEIGHT RATING (FGAWR) WITH SNOW PLOW PREP PACKAGE (4WD MODELS ONLY)

WHEELBASE	REGULAR CAB	EXTENDED CAB	CREW CAB	BODY	ENGINE RPO	ENGINE TYPE	2500HD	3500HD	3500HD
							SRW	DRW	DRW
Short Box	-	-	143.5"	Regular Cab	L96	Gas	5200	5600	5600
						Diesel	6000	6000	6000
Standard Box	119.0"	143.5"	-	Extended Cab Standard Box	L96	Gas	5200	-	-
						Diesel	6000	-	-
Long Box	133.0"	157.5"	-	Extended Cab Long Box	L96	Gas	5600	5600	5600
						Diesel	6000	6000	6000
Crew Cab Standard Box (includes Denali)	-	-	-	Crew Cab Standard Box (includes Denali)	L96	Gas	5200	5600	-
						Diesel	6000	6000	-
Crew Cab Long Box (includes Denali)	-	-	-	Crew Cab Long Box (includes Denali)	L96	Gas	5600	5600	5600
						Diesel	6000	6000	6000

HEAVY-DUTY MAXIMUM PLOW WEIGHTS (4WD MODELS ONLY)

STEERING	Power rack-and-pinion	BODY	ENGINE RPO	ENGINE TYPE	2500HD	3500HD	3500HD		
					2500HD	SRW	DRW		
FUEL TANK CAPACITY (Approx gals.: Short Standard/Long Box)	26.0 / 26.0 / 34.0	Regular Cab	L96	Gas	100/925	100/1000	100/1000		
				Diesel	100/1000	100/975	100/875		
ALTERNATOR (amps)	145	Extended Cab Standard Box	L96	Gas	100/875	-	-		
				Diesel	100/925	-	-		
GVWR ⁸ (Gross Vehicle Weight Rating)	Regular Cab (lbs)	6400	6400-6800	-	Extended Cab Long Box	L96	Gas	100/1000	100/1000
							Diesel	100/875	100/825
Regular Cab (lbs)	6400-7000	7000-7200	-	-	Crew Cab Standard Box (includes Denali)	L96	Gas	100/850	100/1000
							Diesel	100/1000	100/875
Crew Cab (lbs)	6800-7100	7000-7300	6800-7000	-	Crew Cab Long Box (includes Denali)	L96	Gas	100/1000	100/925
							Diesel	100/825	100/775

SRW=Single Rear Wheel DRW=Dual Rear Wheel
100/xxx=100 lbs maximum of permanently attached snow plow mounting hardware/xxx lbs maximum of removable snow plow blade and blade hardware. Maximum plow weights based on a vehicle with average manufacturer option content and 150 lbs each for driver and one additional front-seat occupant. Additional equipment and occupants will reduce maximum plow weight. Rear compensating weight may be required to maintain front axle weight below 65% of total vehicle weight when equipped with snow plow. Consult your snow plow manufacturer for specific compensating weight recommendation.

¹Map coverage for Puerto Rico and the U.S. Virgin Islands available on separate disc. Coverage not available for portions of Canada. ²Go to gm.com/bluetooth to find out which Bluetooth phones are compatible with the vehicle. ³Always use safety belts and the correct restraint for your child's age and size. Even in vehicles equipped with the Passenger Sensing System, children are safer when properly secured in a rear seat in the appropriate infant, child or booster seat. Never place a rear-facing infant restraint in the front seat of any vehicle equipped with a passenger air bag. See the Owner's Manual and child safety seat instructions for more safety information. ⁴Maximum trailer weight ratings are calculated assuming a base vehicle, except for any option(s) necessary to achieve the rating, plus driver. The weight of other optional equipment, passengers and cargo will reduce the maximum trailer weight your vehicle can tow. See your GMC dealer for additional details. ⁵Maximum payload capacity includes weight of driver, passengers, optional equipment and cargo. ⁶Capacities and weight ratings are dependent upon model, engine, transmission and GVWR combinations. See your GMC dealer for details. ⁷Cargo and load capacity limited by weight and distribution. ⁸When properly equipped; includes weight of vehicle, passengers, cargo and equipment.

PART 3

SPEC YOUR MODEL (CONTINUED)

SIERRA HEAVY DUTY SPECIFICATIONS

ENGINES

	VORTEC 6.0L V-8 VVT (L96)	DURAMAX DIESEL 6.6L V-8 TURBO (LML)
FUEL TYPE	Gasoline (FlexFuel)	Diesel (B20 biodiesel capable)
CAPACITY	6.0 liters (364 cu. in.)	6.6 liters (402 cu. in.)
SAE NET HORSEPOWER @ RPM	360 @ 5400 (<10,000-lb GVWR) 322 @ 4400 (>10,000-lb GVWR)	397 @ 3000
SAE NET TORQUE @ RPM (LB-FT)	380 @ 4200	765 @ 1600
TRANSMISSIONS:	Electronically controlled 6-speed heavy-duty automatic transmission with overdrive, electronic engine grade braking and Tow/Haul mode	Electronically controlled Allison 1000 Series 6-speed automatic transmission with overdrive, electronic engine grade braking and Tow/Haul mode

STANDARD TECHNICAL DATA

	All models: Power 4-wheel antilock braking system	
Series / Drive Type	2WD	4WD
BRAKES	14" dia. 4-wheel disc	14" dia. 4-wheel disc
STEERING	Power recirculating ball	Power recirculating ball
FUEL TANK CAPACITY (Approx gals.: Standard / Long Box)	36.0	36.0
ALTERNATOR (Amps)	125	125

CARGO DIMENSIONS²

	STANDARD BOX	LONG BOX
Cargo Volume	60.7 cu. ft.	75.5 cu. ft.
Inside Width at Floor	62.46"	62.46" - 64.70"
Box Length at Floor	78.9"	97.80"

EXTERIOR DIMENSIONS

	REGULAR CAB	EXTENDED CAB	CREW CAB
Height	77.50" - 77.60"	77.60" - 77.90"	78.10" - 78.30"
Overall Length			
Standard Box	-	230.60"	240.20"
Long Box	225.0"	249.50"	259.10"

WHEELBASE

	REGULAR CAB	EXTENDED CAB	CREW CAB
Standard Box	-	144.20"	153.70"
Long Box	133.7"	158.20"	167.70"

MAXIMUM GVWR¹ (GROSS VEHICLE WEIGHT RATING) VORTEC 6.0L V-8/DURAMAX DIESEL 6.6L V-8 TURBO

	REGULAR CAB	EXTENDED CAB	CREW CAB
2500HD			
Standard Box	- / -	9500/10,000	9500/10,000
Long Box	10,000/9900	9500/10,000	9500/10,000
3500HD			
SRW	10,700/11,400	11,000/11,600	11,000/11,600
DRW	13,400/13,000	13,000/13,000	13,000/13,000

SELECT RATINGS All capacities in lbs

MAXIMUM PAYLOAD³

MAXIMUM TRAILERING⁴ BALL HITCH

MAXIMUM TRAILERING⁴ FIFTH-WHEEL OR GOOSENECK

		Vortec 6.0L V-8 / Duramax Diesel 6.6L V-8 Turbo		Vortec 6.0L V-8 / Duramax Diesel 6.6L V-8 Turbo	
2500HD	2WD / 4WD	2WD	4WD	2WD	4WD
Regular Cab Long Box	4212/3538	13,000/13,000	13,000/13,000	14,700/17,800	14,400/17,500
Extended Cab Standard Box	3473/3189	13,000/13,000	13,000/13,000	14,300/17,500	14,000/16,400
Extended Cab Long Box	3358/3275	13,000/13,000	13,000/13,000	14,200/17,400	13,900/15,700
Crew Cab Standard Box	3347/3066	13,000/13,000	13,000/13,000	14,200/17,400	13,900/15,800
Denali Crew Cab Standard Box	3193/2899	13,000/13,000	13,000/13,000	14,000/16,500	13,700/14,700
Crew Cab Long Box	3247/3305	13,000/13,000	13,000/13,000	14,100/16,700	13,800/14,700
3500HD					
Regular Cab SRW	4625/4609	13,000/-	13,000/13,000	14,500/-	14,200/17,400
DRW	7215/6899	14,100/-	13,800/16,000	14,100/-	13,800/23,000
Extended Cab SRW	4459/4455	13,000/13,000	13,000/13,000	14,000/17,300	13,700/16,900
DRW	6321/6033	13,600/16,500	13,400/18,000 ⁵	13,600/22,800	13,400/22,600
Crew Cab SRW Standard Box	4187/4190	13,000/13,000	13,000/13,000	14,000/17,200	13,700/17,000
SRW Long Box	4308/4266	13,000/13,000	13,000/13,000	13,900/17,300	13,600/16,800
Denali SRW	4100/4078	13,000/13,000	13,000/13,000	13,800/17,100	13,600/16,800
DRW	6198/5856	13,500/16,500	13,200/18,000 ⁵	13,500/22,800	13,200/22,400
Denali DRW	6055/5703	13,400/16,500	13,000/18,000 ⁵	13,400/22,600	13,000/22,300

FRONT SUSPENSION⁶ INDEPENDENT TORSION BAR- 2500HD/3500HD

REAR SUSPENSION⁶ SEMI-ELLIPTICAL MULTILEAF-2500HD/3500HD-SRW/3500HD-DRW

STANDARD FRONT AXLE CAPACITY	2WD	4WD	REAR AXLE CAPACITY	2WD	REAR AXLE CAPACITY	4WD
Regular Cab (lbs)	4400 / 4400	4400 / 4400	Regular Cab (lbs)	6200 / 7050 / 9825	Regular Cab (lbs)	6200 / 7050 / 9825
Extended Cab (lbs)	4400 / 4400	4400 / 4800	Extended Cab (lbs)	6200 / 7050 / 9375	Extended Cab (lbs)	6200 / 7050 / 9375
Crew Cab (lbs)	4400 / 4400	4800 / 4800	Crew Cab (lbs)	6200 / 7050 / 9375	Crew Cab (lbs)	6200 / 7050 / 9375
STANDARD FRONT SPRING CAPACITY			REAR SPRING CAPACITY		REAR SPRING CAPACITY	
Regular Cab (lbs)	4400 / 4400	4400 / 4400	Regular Cab (lbs)	6200 / 7050 / 9825	Regular Cab (lbs)	6200 / 7050 / 9375
Extended Cab (lbs)	4400 / 4400	4800 / 4800	Extended Cab (lbs)	6200 / 7050 / 9375	Extended Cab (lbs)	6200 / 7050 / 9375
Crew Cab (lbs)	4400 / 4400	4800 / 4800	Crew Cab (lbs)	6200 / 7050 / 9375	Crew Cab (lbs)	6200 / 7050 / 9375

SRW-Single Rear Wheel DRW-Dual Rear Wheel

GMC ACCESSORIES FOR YOUR SIERRA

Engineered to the same standards as your Sierra, GMC Accessories help you to tailor your truck to your needs. From simple add-ons like floor mats and splash guards, to a brilliant array of chrome wheels and accents, you can make your Sierra ready for anything from a long day of work to a night on the town.

DEALER-INSTALLED AUTONET WIFI¹



Turn your Sierra into a mobile hot spot with the first wireless router engineered specifically for automotive use. It can accommodate up to 10 wireless devices at one time, at a range of up to 150 feet, to help you stay connected, whether you're on the job or at your favorite hideaway.

INTEGRATED DVD



A Dual-Player DVD System mounted in back of each front head restraint with wireless headphones gives rear-seat passengers personal entertainment. Single remote control included.

CHROME MIRROR COVER



Help your Sierra make a fashion statement with these chrome outside rearview mirror covers.

OVAL-PATTERN CHROME GRILLE



This sporty chrome grille features a chrome mesh center and surround. It replaces the existing grille.

ASSIST STEPS

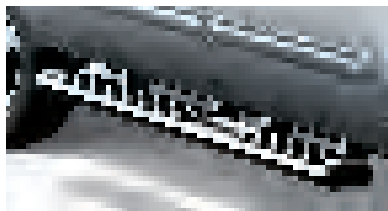

Make it easier to get in and out of your truck with these stylish assist steps. Crafted from rust-resistant stainless steel, they are available in either chrome or black powder coat and in 6-inch oval or 3-inch round styles.

SOFT TONNEAU COVER



Roll-up design shields cargo, easily rolls up to allow full access to the bed and is constructed with integrated crossbows.

20" AND 22" CAST CHROME WHEELS²

Fill up your wheel wells and stand out from the crowd with these factory-engineered and approved wheels from GMC Accessories. Each wheel features a brilliant durable chrome finish and is available with matching lugs and GMC logo center caps.



CK948 20" CHROME



CK951 20" CHROME



CK370 20" CHROME



CK991 20" CHROME



CK997 20" CHROME



CK945 20" CHROME



CK916 22" CHROME



CK366 TRI-SPOKE 22" CHROME



CK375 22" CHROME

OVERHEAD UTILITY RACK



The overhead utility rack mounts to the available Cargo Management System rails and supports up to 500 lbs.² The rear supports slide along the Cargo Management System rails to enhance functionality.

STATIONARY TOOLBOX



Diamond-patterned toolbox features dual gas shocks for smooth opening and closing and GMC logo.

¹When properly equipped; includes weight of vehicle, passengers, cargo and equipment. ²Cargo and load capacity limited by weight and distribution. ³Maximum payload capacity includes weight of driver, passengers, optional equipment and cargo. ⁴Maximum trailer weight ratings are calculated assuming a base vehicle, except for any option(s) necessary to achieve the rating, plus driver. The weight of other optional equipment, passengers and cargo will reduce the maximum trailer weight your vehicle can tow. See your GMC dealer for additional details. ⁵Available fourth quarter 2011. ⁶Capacities and weight ratings are dependent on model, engine, transmission and GVWR combinations. See your GMC dealer for details. ⁷Monthly rates apply. Visit autonetmobile.com for coverage map and details. ⁸Use only GM-approved tire and wheel combinations. Unapproved combinations may change the vehicle's performance characteristics. For approved tire and wheel combinations and other important information, go to gmaccessorieszone.com or see your dealer for details.

COMMITMENT PLUS

From the owner orientation—and full tank of gas—you receive when you take possession of your Sierra to the **24-Hour Roadside Assistance, Courtesy Transportation and Travel Benefits**, Commitment Plus is a portfolio of owner privileges that lasts throughout your warranty. For expert product information, Roadside Assistance or other services, call 1-800-GMC-8782.

TRAVEL BENEFITS AND ROADSIDE ASSISTANCE Available around the clock: trip routing service, a program for reimbursement for trip interruption due to necessary warranty repairs, towing, flat tire change, jump-starts and more for 5 years or 100,000 miles (whichever comes first).

COURTESY TRANSPORTATION Available at participating dealers: shuttle service, reimbursement of certain public transportation or fuel expenses for overnight warranty repairs, and courtesy rental for overnight work repairs. See your dealer for details.

GMC OWNER CENTER A complimentary, one-stop resource to enhance your GMC ownership experience. It's easy to sign up. Just go to gm.com/gmownercenter/gmc.

ONSTAR



OnStar is a core asset of your Sierra. Benefiting from more than a decade of innovative development, it is both a highly advanced technology—fully integrated within the vehicle—and a warm human service. Standard on all Sierra models are 6 months of the OnStar Directions & Connections Plan, including the convenience of available Hands-Free Calling. It also includes Automatic Crash Response, Stolen Vehicle Assistance, link to Emergency Services, Roadside Assistance, Remote Door Unlock, OnStar Vehicle Diagnostics, Crisis Assist and Remote Horn and Lights. OnStar services require vehicle electrical system (including battery), wireless service and GPS satellite signals to be available and operating for features to function properly. OnStar acts as a link to existing emergency service providers. Visit onstar.com for coverage maps, details and system limitations. Services vary with conditions.

HANDS-FREE CALLING

Available OnStar Hands-Free Calling capability is built into your Sierra. It's there when your cell phone is unavailable, its battery is low, you can't reach it easily or you left it at home or in the office. Your Hands-Free Calling system is the right choice whenever you need an easy way to make and receive calls—at the touch of the phone icon on the rearview mirror or the steering-wheel-mounted controls. Voice-activated dialing is convenient because you don't have to dial when you are at the wheel. And Hands-Free Calling is reliable because it's specially designed for better reception and fewer dropped calls in areas of limited cellular reception.

ONSTAR TURN-BY-TURN NAVIGATION

Standard on all Sierra models are 6 months of the OnStar Directions & Connections Plan that adds innovative, easy-to-use Turn-by-Turn Navigation plus Information and Convenience Services and Driving Directions. With Turn-by-Turn Navigation, you simply tell the OnStar Advisor your intended destination, and directions will automatically be sent to your Sierra. If you drive off course, the system can reroute you to your intended destination. An automated voice then guides you turn-by-turn until you arrive at your destination. Turn-by-Turn Navigation is further enhanced with eNAV, allowing you to send Google™ Maps and MapQuest™ directions directly to your vehicle. No need to print out directions; just call them up with simple voice commands.

SIRIUSXM SATELLITE RADIO



SiriusXM Satellite Radio¹ is standard on all Sierra models. It includes 3 trial months of service. SiriusXM Satellite Radio makes your drive come alive with commercial-free music channels from virtually every genre, artist-dedicated channels, live performances and more. Tune in to live play-by-play from the biggest sports, exclusive entertainment from top personalities, compelling talk, hilarious comedy, world-class news, local traffic and weather and family-friendly programming. Welcome to the world of satellite radio. Visit siriusxm.com for details.

GMC CERTIFIED SERVICE

GMC Certified Service To help your Sierra live up to its performance promise, GMC Certified Service—found exclusively at your GMC dealer—is there. With all the engineering excellence in Sierra, GM-trained technicians have the expertise to care for all of it.

A NOTE ON CHILD SAFETY Always use safety belts and the correct restraint for your child's age and size. Even in vehicles equipped with the Passenger Sensing System, children are safer when properly secured in a rear seat in the appropriate infant, child or booster seat. Never place a rear-facing infant restraint in the front seat of any vehicle equipped with a passenger air bag. See the Owner's Manual and child safety seat instructions for more safety information.

TRAILERING AND OFF-ROAD INFORMATION Please carefully review the Owner's Manual for important safety information about trailering or off-road driving in your vehicle.

IMPORTANT WORDS ABOUT THIS CATALOG We have tried to make this catalog comprehensive and factual. We reserve the right, however, to make changes at any time, without notice, in prices, colors, materials, equipment, specifications, models and availability. Specifications, dimensions, measurements, ratings and other numbers in this catalog and other printed materials provided at the dealership or affixed to vehicles are approximates based upon design and engineering drawings and prototypes and laboratory tests. Your vehicle may differ due to variations in manufacture and equipment. Since some information may have been updated since the time of printing, please check with your GMC dealer for complete details. GMC reserves the right to lengthen or shorten the model year for any product for any reason, or to start and end model years at different times.

FLEET ORDERS Some standard content may be deleted with fleet orders. See dealer for details.

ENGINES GMC products are equipped with engines produced by GM Powertrain or other suppliers to GM worldwide. The engines in GMC products may also be used in other GM makes and models.

GMC.COM See more of Sierra on our Web site: gmc.com/sierra. More photos and information; hot links to related subjects; convenient dealer locator; pricing guide, spec out your own vehicle. Or call 1-800-GMC-8782.

AN IMPORTANT NOTE ABOUT ALTERATIONS AND WARRANTIES Installations or alterations to the original equipment vehicle (or chassis) as distributed by General Motors are not covered by the General Motors New-Vehicle Limited Warranty. The special body company, assembler, equipment installer or upfitter is solely responsible for warranties on the body or equipment and any alterations (or any effect of the alterations) to any of the parts, components, systems or assemblies installed by GM. General Motors is not responsible for the safety or quality of design features, materials or workmanship of any alterations by such suppliers.

NEW-VEHICLE LIMITED WARRANTY All GMC light-duty vehicles come with a fully transferable, no-deductible 5-year/100,000-mile (whichever comes first) Powertrain Limited Warranty. GM vehicles registered in the U.S.A. are also covered for 3 years or 36,000 miles (whichever comes first). Coverage includes tires and towing to your nearest GMC dealership. Repairs will be made to correct any vehicle defect and most warranty repairs will be made at no charge. In addition, rust-through corrosion will be covered for 6 years or 100,000 miles (whichever comes first). See dealer for details.

ASSEMBLY GMC vehicles and their components are assembled or produced by different operating units of General Motors, its subsidiaries or suppliers to GM worldwide. We sometimes find it necessary to produce GMC vehicles with different or differently sourced components than originally scheduled. Since some options may be unavailable when your vehicle is assembled, we suggest that you verify that your vehicle includes the equipment you ordered or, if there are changes, that they are acceptable to you.

GMMOBILITY.COM [1-800-323-9935] GM Mobility offers financial assistance for eligible adaptive equipment to make automotive travel easier for persons with disabilities or special transportation needs. To learn more about special GM Mobility offers, visit gmmobility.com.

GMCARDMEMBERSERVICES.COM Did you know about the family of reward credit cards that can help you get a great deal on a new GM car, light-duty truck, SUV or crossover? With a GM reward card, you accrue earnings on every credit card purchase to use toward the purchase or lease of an eligible new GM vehicle. With three cards to choose from, you're sure to find one that suits you.

¹Requires a subscription, sold separately by SiriusXM after the trial period. SiriusXM Radio service only available in the 48 contiguous United States and the District of Columbia. For more information and to view Customer Agreement, visit siriusxm.com.

©2011 General Motors. All rights reserved. GM, the GM logo, GMC, the slogans, emblems, vehicle model names, vehicle body designs and other marks appearing in this catalog are the trademarks and/or service marks of General Motors, its subsidiaries, affiliates or licensors. Bose, Centerpoint, AudioPilot and SurroundStage are registered trademarks of Bose Corporation. iPhone and iPod are registered trademarks of Apple, Inc. Facebook is a registered trademark of Facebook, Inc. Twitter is a registered trademark of Twitter, Inc. YouTube is a registered trademark of Google, Inc. SiriusXM is a registered trademark of SiriusXM Satellite Radio. All sculptures ©2006-2011 Robert Lobe.



COLORS

ONYX BLACK¹



CARBON BLACK METALLIC³



SUMMIT WHITE¹



QUICKSILVER METALLIC



WHITE DIAMOND TRICOAT²



FIRE RED



STEEL GRAY METALLIC

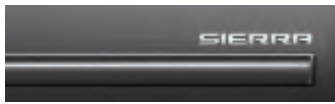

MIDNIGHT BLUE METALLIC³



STEALTH GRAY METALLIC³

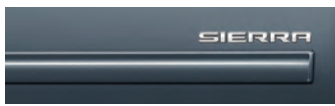

MOCHA STEEL METALLIC³



INTERIOR MATERIALS

VINYL

[Standard: WT trim]



DARK TITANIUM

CLOTH

[Standard: SL trim; Available: WT trim]



DARK TITANIUM

PREMIUM CLOTH

[Standard: SLE trim, Hybrid and XFE]

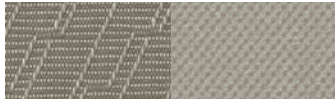

LIGHT TITANIUM

LEATHER-APPOINTED

[Standard: SLT trim; Available: SLE trim, Hybrid and XFE]



LIGHT TITANIUM

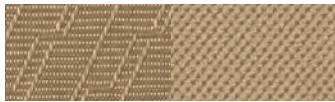

LIGHT CASHMERE



LIGHT CASHMERE



EBONY

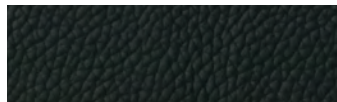

EBONY

SIERRA ALL-TERRAIN INTERIOR TRIM

Premium Cloth [Standard: SLE trim]



EBONY

PERFORATED LEATHER-APPOINTED

[Standard: Sierra Denali; Available: Sierra SLT]



LIGHT TITANIUM⁵

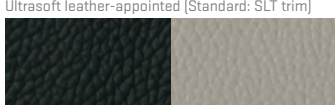

EBONY/LIGHT TITANIUM



COCOA/LIGHT CASHMERE

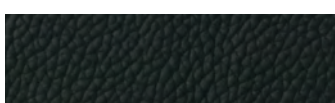

EBONY



EBONY

WHEEL AVAILABILITY/SIERRA SELECT MODELS

SIERRA/1500 WHEELS⁴



NX7
17" PAINTED STEEL
S: WT TRIM



PY9
17" CHROME-STYLED STEEL
S: SLE TRIM AND SL CREW CAB
A: WT REGULAR OR EXT CAB



R08
18" CHROME-CLAD ALUMINUM
S: SLT AND HYBRID



S86
20" CHROME-CLAD ALUMINUM
A: SLE AND SLT



N88
17" POLISHED ALUMINUM SPORT
S: XFE
A: SLE AND SLT W/MAX TRAILERING PACKAGE



RZF
18" CHROME-CLAD ALUMINUM
S: ALL-TERRAIN PACKAGE



P41
20" CHROMED ALUMINUM
S: SIERRA DENALI

2500HD WHEELS⁴



PYN
17" PAINTED STEEL
S: WT



PYP
17" CHROME-CLAD STEEL
A: WT



PYQ
17" CAST-ALUMINUM BRIGHT MACHINED
S: SLE



PYS
20" ALUMINUM
A: SLE, SLT

2500HD/3500HD SRW WHEELS⁴



PYT
18" PAINTED STEEL
S: 3500HD WT
A: 2500HD WT



PYR
18" FORGED POLISHED ALUMINUM
S: 2500HD SLT
S: 3500HD SLE, SLT
A: 2500HD SLE

DENALI HD SRW WHEELS⁴



PYR
18" FORGED POLISHED ALUMINUM
S: 2500 & 3500 DENALI HD



PYS
20" ALUMINUM
A: 2500 DENALI HD

3500HD DRW WHEELS⁴



PYW
17" PAINTED STEEL
S: WT



P06
17" CHROME SKINS AND CENTER CAPS
S: SLE, SLT



RS7
17" FORGED POLISHED ALUMINUM
S: 3500 DENALI HD DRW
A: 3500HD SLE/SLT DRW

All colors are basecoat/clearcoat for high-gloss and durable finish. See your dealer for more details on color and trim options. ¹Available on Denali. ²Available on Crew Cab and 1500 Denali. ³Available fall 2011. ⁴Use only GM-approved tire and wheel combinations. For approved tire and wheel combinations and other important information, go to gmaccessorieszone.com or see your dealer for details. ⁵Color not available on Denali.

