

JAGUAR F-TYPE



THE ART OF PERFORMANCE





BY APPOINTMENT TO
HM THE QUEEN
MANUFACTURERS OF
MOTOR VEHICLES
JAGUAR LAND ROVER LIMITED
COVENTRY



BY APPOINTMENT TO
HRH THE DUKE OF EDINBURGH
MANUFACTURERS OF
MOTOR VEHICLES
JAGUAR LAND ROVER LIMITED
COVENTRY



BY APPOINTMENT TO
HRH THE PRINCE OF WALES
MANUFACTURERS OF
MOTOR VEHICLES
JAGUAR LAND ROVER LIMITED
COVENTRY



JAGUAR

THE ART OF PERFORMANCE

Every day we push performance to its limit. Our performance. Our cars' performance.
We innovate, we engineer, we design. We master rules and then break them.
Only to push further. Past the limits of convention. This is when performance becomes art.

Jaguar. The Art of Performance.



CONTENTS

INTRODUCTION

The Concept of the F-TYPE	06
The F-TYPE - The Facts	08

DESIGN

Exterior Principles	10
Exterior Detail	12
Interior	15
Interior Technology	17
Luggage Space	18

PERFORMANCE

Engines	20
Automatic Transmission	24
Manual Transmission	25
Advanced Aerodynamics	27
Lightweight Aluminum Architecture	28
Chassis and Suspension	30
Tested to the Extreme	33

DRIVING TECHNOLOGY

Advanced Driving Dynamics	34
Dynamic Mode	36
Advanced Drivetrain Technology	39
Torque Vectoring	41
Stability and Control	43
Performance Braking Systems	45

INFOTAINMENT

Jaguar InControl® Technologies	46
Audio	50

ASSISTANCE AND EFFICIENCY

Advanced Driver Assistance	52
Efficient Technologies	54

F-TYPE R

R	56
Performance	59
Interior	60

F-TYPE SVR

SVR	62
The Concept of SVR	65
Special Vehicle Operations	67
Aerodynamics	68
Lightweight Technologies	71
Interior	73

PERSONALIZATION

The F-TYPE - Your Choice	74
Choose your Engine	76
Choose your Model & Packages	78
Choose your Color	90
Choose your Wheels	92
Choose your Interior	94
Choose your Jaguar Accessories	108
Technical Specifications	112
Dimensions	114

JAGUAR WORLD

Jaguar Experience	116
The World of Jaguar	118
Glossary and Legal Information	120



Scan to find out more about the F-TYPE

VEHICLE SHOWN: F-TYPE S IN CALDERA RED

SOME OF THE VEHICLES FEATURED IN THE PHOTOGRAPHS THROUGHOUT THIS BROCHURE ARE EUROPEAN MODELS AND MAY NOT BE AVAILABLE IN NORTH AMERICA. PLEASE CONSULT YOUR LOCAL JAGUAR RETAILER FOR SPECIFIC MODEL AVAILABILITY.

INTRODUCTION

THE CONCEPT OF THE F-TYPE

The F-TYPE is the latest in a distinguished bloodline of powerful, agile and utterly distinctive cars. It looks, feels and drives like a true Jaguar sports car. Coupe or Convertible, Rear Wheel or All Wheel Drive, manual or automatic, every F-TYPE showcases the exhilarating performance, state-of-the-art handling and cutting-edge technology of Jaguar to deliver an unrivaled driver-focused experience.

Responsive supercharged engines. Lightweight aluminum body construction. Sophisticated suspension. Jaguar InControl® Technologies to link you and your F-TYPE to the wider world. And options that include All Wheel Drive and Intelligent Driveline Dynamics⁵ for even greater performance capabilities, advanced technologies that improve your driving experience and keep you connected.

The F-TYPE range offers sports cars that only Jaguar could create, and it now encompasses the most powerful production car Jaguar has ever unleashed: F-TYPE SVR. Featuring enhanced suspension, advanced aerodynamics, lightweight technologies and a recalibrated engine, the F-TYPE SVR takes the F-TYPE range to exceptional new levels. In every F-TYPE, performance and art combine to deliver a car that is intensely Jaguar, a car that embodies the Art of Performance.

VEHICLE SHOWN: F-TYPE SVR IN FIRESAND WITH OPTIONAL FEATURES FITTED

Disclaimers apply. Please see page 120 for further details.





THE F-TYPE - THE FACTS

Stunning design, exhilarating performance, instant response, agile handling and advanced technology. The F-TYPE is created to deliver breathtaking driving experiences.

ALL WHEEL DRIVE

All Wheel Drive uses Intelligent Driveline Dynamics software to analyze the behavior of the car, ensuring correct levels of front-to-rear torque when needed. The system preserves the legendary Jaguar handling while maximizing traction and efficiency.

TECHNOLOGY

The F-TYPE is as connected to the world as it is to the road. Our suite of Jaguar InControl® Technologies ensure that your personal devices can be seamlessly integrated with your car so you are conveniently up-to-date and in touch at all times. The Jaguar InControl® system also allows you to remotely monitor your F-TYPE via your smartphone.

— JAGUAR ELITECARE —
**BEST IN CLASS
COVERAGE***
— 5 YEARS 60,000 MILES —

JAGUAR ELITECARE

Enjoy your Jaguar with complete peace of mind. The F-TYPE is now backed by the Best-In-Class Jaguar EliteCare*, our exceptional 5 year / 60,000 mile coverage program including New Vehicle Limited Warranty, Complimentary Scheduled Maintenance, Roadside Assistance and InControl Remote & Protect™.

VEHICLE SHOWN: F-TYPE R IN STORM GREY

*Class is cars sold by luxury automobile brands and claim is based on total package of warranty, maintenance and other coverage programs. For complete details regarding Jaguar EliteCare coverage, visit JAGUARUSA.COM, call 1.800.4.JAGUAR or visit your local Jaguar Retailer. Disclaimers apply. Please see page 120 for further details.

HANDLING AND AGILITY

To optimize the handling and agility of the F-TYPE a range of driving technologies are available. These include Torque Vectoring, Adaptive Dynamics and an Electronic Active Differential⁵. Each one works to enhance the driving experience through increased control, traction and feel.

DESIGN

The beauty of its lines, the purity of its form – the design of the F-TYPE is a joy to behold. Coupe and Convertible bodystyles are available. Each has its own unique character, but both offer the thrills of the F-TYPE performance and handling.

SUPERCHARGED PERFORMANCE

All F-TYPE engines use a twin vortex supercharger to eliminate acceleration lag. Throttle response is instantaneous with seamless power delivery and high levels of torque at all engine speeds. The latest engine to use this technology is the V8 unit found in the F-TYPE SVR which makes it the most powerful Jaguar production car ever.



ADVANCED BRAKING

Power demands control – it's why we offer a number of braking systems across the F-TYPE range to match each car's performance. All deliver confident, progressive feel and consistent response. Carbon Ceramic Brakes offer up to 46lbs of weight saving and sustained performance in demanding conditions.

CHOICE OF TRANSMISSIONS

The F-TYPE range offers a lightning-fast automatic transmission, with fingertip paddleshift control. It is intelligent and adaptive to exploit the responsive power of the F-TYPE. A lightweight manual transmission is also available for a more involving drive.

DESIGN EXTERIOR PRINCIPLES

AWARD-WINNING DESIGN

The F-TYPE is a true performance car. Its powerful shape, proportions and style have earned international acclaim as the 2013 World Car Awards' Design of the Year.

"A piece of design should tell a story. The F-TYPE lines have a start, a direction and a conclusion. Make every line individual and aesthetically correct, with the right dimensions, and it will stand the test of time."

Ian Callum, Jaguar Design Director

VEHICLE SHOWN: F-TYPE S AWD IN BLACK BERRY





EXTERIOR DETAIL

POWERFUL FORM

Rising vertically from the front spoiler and running up through elongated headlamps, the beautifully flowing body line of the F-TYPE begins to take shape. The line arcs over the front wheel, descending elegantly as it runs across the door, before culminating in a pronounced muscular rear haunch. The F-TYPE leaves you under no illusion that this is a high performance sports car – the latest in a distinguished bloodline.

It is, in part, sculpted by the wind itself, formed by the Jaguar state-of-the-art Computational Fluid Dynamics design methods. A front splitter beneath the grille and rear venturi manage airflow along the underside, while a deployable rear spoiler automatically rises at higher speeds to increase downforce and reduce drag. Even the door handles retract when not required, their flush design creating an uninterrupted air flow along the F-TYPE flanks.

VEHICLE SHOWN: F-TYPE S IN AMMONITE GREY WITH OPTIONAL FEATURES FITTED







INTERIOR



CONNECTING DRIVER AND MACHINE

SUPERIOR CRAFTSMANSHIP

In the F-TYPE you and the car become one. Every aspect of its 1+1 configuration is designed to create a bond. It wraps around you, taking your driving experience to greater heights.

The cockpit provides maximum visibility, minimal distractions and close-to-the-center-of-gravity seating for a complete connection with the car. The low fascia is free from clutter to increase the view ahead. The Active Central Air Vent, part of the advanced climate control system, hides the twin central air vents, which automatically rise from the dashboard as required and retract after use.

Choose standard Sport seats or the optional Performance seats. Performance seats are available in Premium Leather or Suedecloth, both offer enhanced lateral support during dynamic driving. Sport seats can also be specified with the optional Premium Leather interior that finishes the seats, upper fascia, center console and door casings. Premium Leather interior with twin needle stitching and Performance seats are standard on F-TYPE R and F-TYPE SVR. F-TYPE SVR is also exclusively available with Quilted Leather.

VEHICLE SHOWN: F-TYPE S FEATURING CIRRUS PREMIUM LEATHER PERFORMANCE SEATS WITH JET CONTRAST STITCH



INTERIOR TECHNOLOGY



PERFECTLY POSITIONED

FAST AND INTUITIVE

The F-TYPE keeps things simple so you can concentrate on enjoying the drive. It presents information only as necessary or when requested. Simple, clear and easy to read instruments feature two large analog dials – essential in any sports car.

The three-spoke steering wheel incorporates key controls for ease of use. On models fitted with the Quickshift eight-speed automatic gearbox, gearshift paddles mounted behind the spokes give manual control so you don't have to take your hands off the wheel. The SportShift Selector is simple and intuitive, offering full Auto mode and manual operation in Sport mode. You can select gears sequentially by tipping the lever forward to shift down a ratio or shift up a gear by pulling the lever back.

The 8 inch color Touch-screen fitted to the F-TYPE is your single interaction point with the Jaguar infotainment system¹. This gives you direct control over navigation, music, phone, climate and many additional driver support systems including parking aids.

Dual Mode Rotary Switches control elements of the advanced climate control system. Right and left dials control cockpit temperature on each side of the car when dual zone climate control is specified. These dials also control the optional seat heating functions*.

*Heated seats are standard on F-TYPE R and F-TYPE SVR derivatives.

VEHICLE SHOWN: F-TYPE S FEATURING CIRRUS PREMIUM LEATHER PERFORMANCE SEATS WITH JET CONTRAST STITCH

Disclaimers apply. Please see page 120 for further details.

LUGGAGE SPACE



14.4 CU.FT.



OPTIONAL POWERED TAILGATE*

The F-TYPE Coupe trunk is large enough to take a full set of luggage or two sets of golf clubs, with up to 14.4 cu.ft. of capacity. For ease of access the tailgate can be opened or closed at the touch of a button with the powered function.

*Option only available on Coupe derivatives. Standard feature on F-TYPE R and F-TYPE SVR derivatives.
VEHICLE SHOWN: F-TYPE S IN BLACK BERRY



FITVEL

VYW 880

PERFORMANCE ENGINES



SUPERCHARGED ENGINES

RESPONSIVE POWER

The beating of the F-TYPE heart is supercharged – delivering high levels of torque at all engine speeds, so there's no delay between the driver's demand for power and the engine's response. When cruising the engine thrums subtly, hinting at the latent potential of the F-TYPE. Tap the accelerator and the engine growls with the promise of more power. As the revs rise the Sports Exhaust builds to a race-car inspired crescendo.

The Sports Exhaust is standard on the F-TYPE and the F-TYPE Premium with automatic transmissions. Active bypass valves allow exhaust gases to exit more directly, delivering a deeper, more dramatic sound. F-TYPE and F-TYPE Premium derivatives with manual transmissions, as well as the F-TYPE S, F-TYPE R and F-TYPE SVR have the Switchable Active Exhaust fitted as standard, allowing manual control of the system, for even greater driver involvement. The Switchable Active Exhaust on the SVR is made from Titanium and Inconel®, resulting in a 35.2 lbs weight saving and a supercar soundtrack.



START

ENGINE

STOP

ENGINES

The F-TYPE offers two highly advanced engines with two power outputs each: 3.0 V6 340HP, 3.0 V6 380HP, 5.0 V8 550HP and 5.0 V8 575HP. Each features a Roots-type twin vortex supercharger that maintains the engine's compact dimensions. To improve fuel economy, particularly during city driving, a fast-reacting Intelligent Stop/Start system is fitted to every F-TYPE as standard.

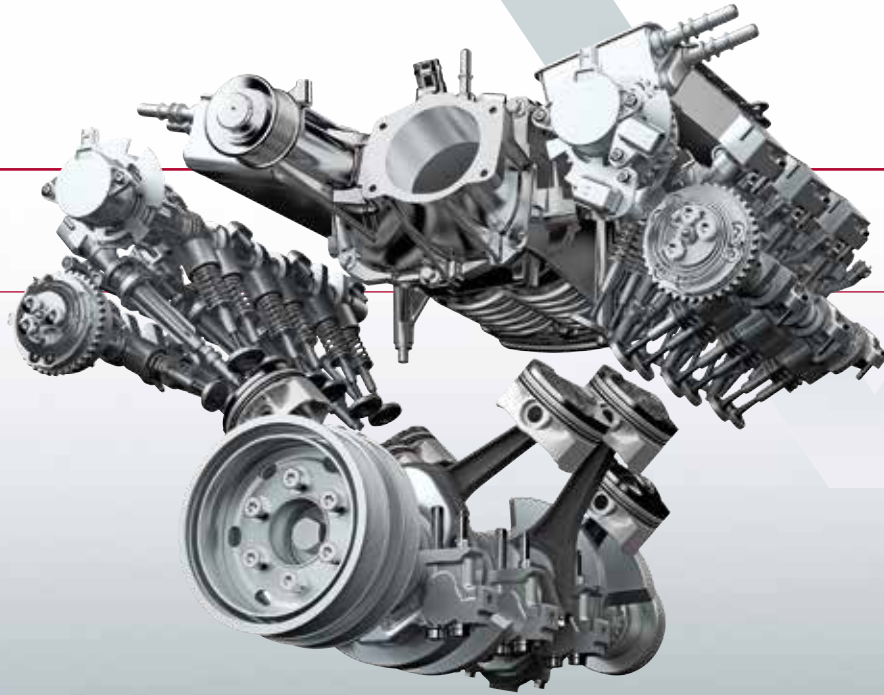

V6 ENGINES

0-60mph from 4.8 sec

Powerful and refined, for a thrilling and rewarding drive. The compact supercharger's sophisticated boost control and secondary throttle valve give you a burst of power when you accelerate, with no lag. The water-cooled intercooler reduces air intake temperature for more power and efficiency. Power is smoothed and refined by innovative counter-rotating front and rear balancer weights. The 3.0 V6 340HP engine achieves 332 lb-ft of torque and acceleration is 0-60mph in 5.1 seconds*⁸. The V6 engine in the F-TYPE S has been modified to achieve a higher power output of 380HP and 339 lb-ft torque for even more potent performance. Acceleration is 0-60mph in 4.8 seconds*⁸.

*Applicable to RWD models with Automatic transmission only.
Disclaimers apply. Please see page 120 for further details.

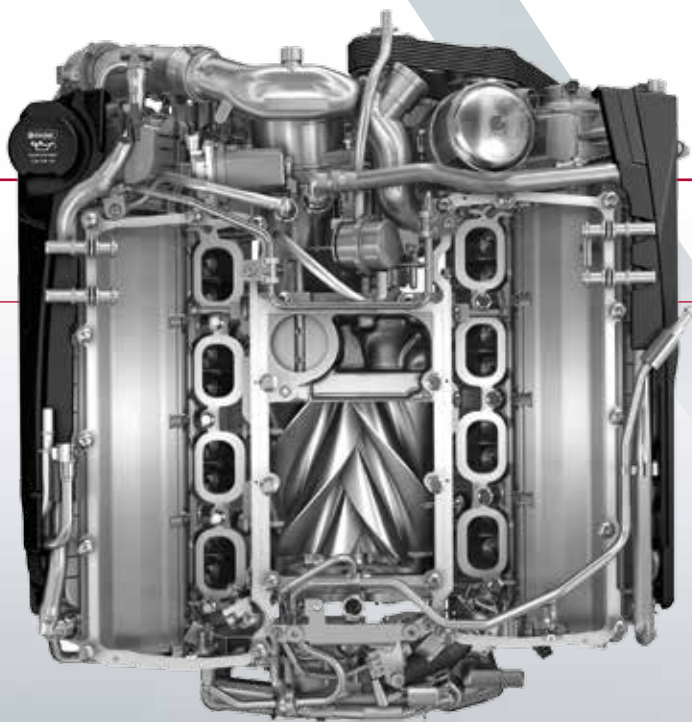

V8 ENGINES

0-60mph from 3.5 sec

Lightweight and powerful, this engine features a die-cast aluminum block to reduce weight. Dual independent variable cam timing optimizes power at any speed. Cleaner, more efficient combustion is achieved by spray-guided direct injection of precisely measured quantities of fuel directly into the center of the combustion chamber. The F-TYPE R 5.0 V8 delivers up to 550HP and with an impressive 502 lb-ft of torque. Acceleration is 0-60mph from 3.9 seconds⁸. The F-TYPE SVR 5.0 V8 engine is the pinnacle of power, recalibrated to deliver up to an astonishing 575HP and 516 lb-ft of torque. Acceleration is 0-60mph from 3.5 seconds⁸.

AUTOMATIC TRANSMISSION

EIGHT-SPEED AUTOMATIC GEARBOX

Our eight-speed Quickshift automatic gearbox offers an unequalled blend of lightning-fast changes and superb refinement. Available on every F-TYPE, its eight closely-spaced ratios keep the engine within its most effective rev range for longer. The transmission control system is intelligent and adaptive. It monitors the driving situation together with the demands the driver is making on the car, and responds to provide a truly dynamic experience. Adaptive software automatically modifies the gearshift strategy, ensuring the right gear is selected for every situation.

You can also take full manual control with the gearshift paddles mounted behind the steering wheel, or the joystick-style SportShift selector. Dynamic Launch Mode is standard on the F-TYPE S. It ensures maximum torque through every gear change, for optimum acceleration from 0-60mph⁸.

Disclaimers apply. Please see page 120 for further details.



MANUAL TRANSMISSION

SIX-SPEED MANUAL TRANSMISSION

There's nothing more thrilling than changing gear manually in a sports car. Our lightweight six-speed manual gearbox provides that thrill. Designed for the high-revving V6 with rear-wheel drive (RWD) configuration, it's the perfect choice for sports car purists. The precision-engineered short-throw gear lever delivers snappy changes. The close ratio, six-speed manual gearbox enables the driver to keep the engine within its optimum rev range for longer. The pedals are perfectly placed for heel-and-toe changes, defining the definitive Jaguar sports car experience. Manual transmission is available on F-TYPE, F-TYPE Premium and F-TYPE S models.





ADVANCED AERODYNAMICS



DEPLOYABLE REAR SPOILER

LOW DRAG AND HIGH STABILITY

Aerodynamic performance is at the heart of the design. It is seamlessly integrated into the body for low levels of lift and excellent stability at high speed. Even the door handles retract to create an uninterrupted airflow along its flanks. The deployable rear spoiler rises at higher speeds to reduce lift by up to 264 lbs. A front splitter beneath the grille manages airflow along the vehicle's underside, with the sharply defined tail helping to separate air cleanly at lower speeds. The result is improved handling and stability.

VEHICLE SHOWN: F-TYPE S IN RHODIUM SILVER WITH OPTIONAL FEATURES FITTED

LIGHTWEIGHT ALUMINUM ARCHITECTURE



STRONG AND RIGID

HIGH POWER-TO-WEIGHT AND TORQUE-TO-WEIGHT RATIOS



A lightweight aluminum body with a strong, stiff structure is the perfect platform for a sports car. Jaguar pioneered this technology over a decade ago and continue to push the boundaries today. It informs every aspect of how the F-TYPE performs, handles and feels. A strong, stiff structure provides an inherently stable platform for precise, agile handling and allows the finely-tuned suspension system to deliver connectivity and driver feedback. Lightweight aluminum panels are bonded together with a super-strong adhesive, then punched with zinc-coated, boron steel rivets that compress the adhesive to form an airtight bond for phenomenal strength and rigidity. The F-TYPE body is the perfect complement to its high-performance engine range. Together they produce the exceptional power-to-weight and torque-to-weight ratios that deliver the real world measures of performance in a sports car.

The exterior panels are made from specially developed alloys. They combine robustness with greater formability, which gives clarity and tightness to curves and feature lines. On Coupe models, the side pressing is one of the most technically advanced in the automotive industry. It allows for cleaner lines with an extraordinarily beautiful, uninterrupted sweep from the front pillar to the trailing edge. This combination of advanced materials and innovative techniques has two advantages. It allows us to reproduce the crisp, crafted lines of the F-TYPE, exactly as the designers intended. And it delivers a vehicle with extraordinary structural integrity.



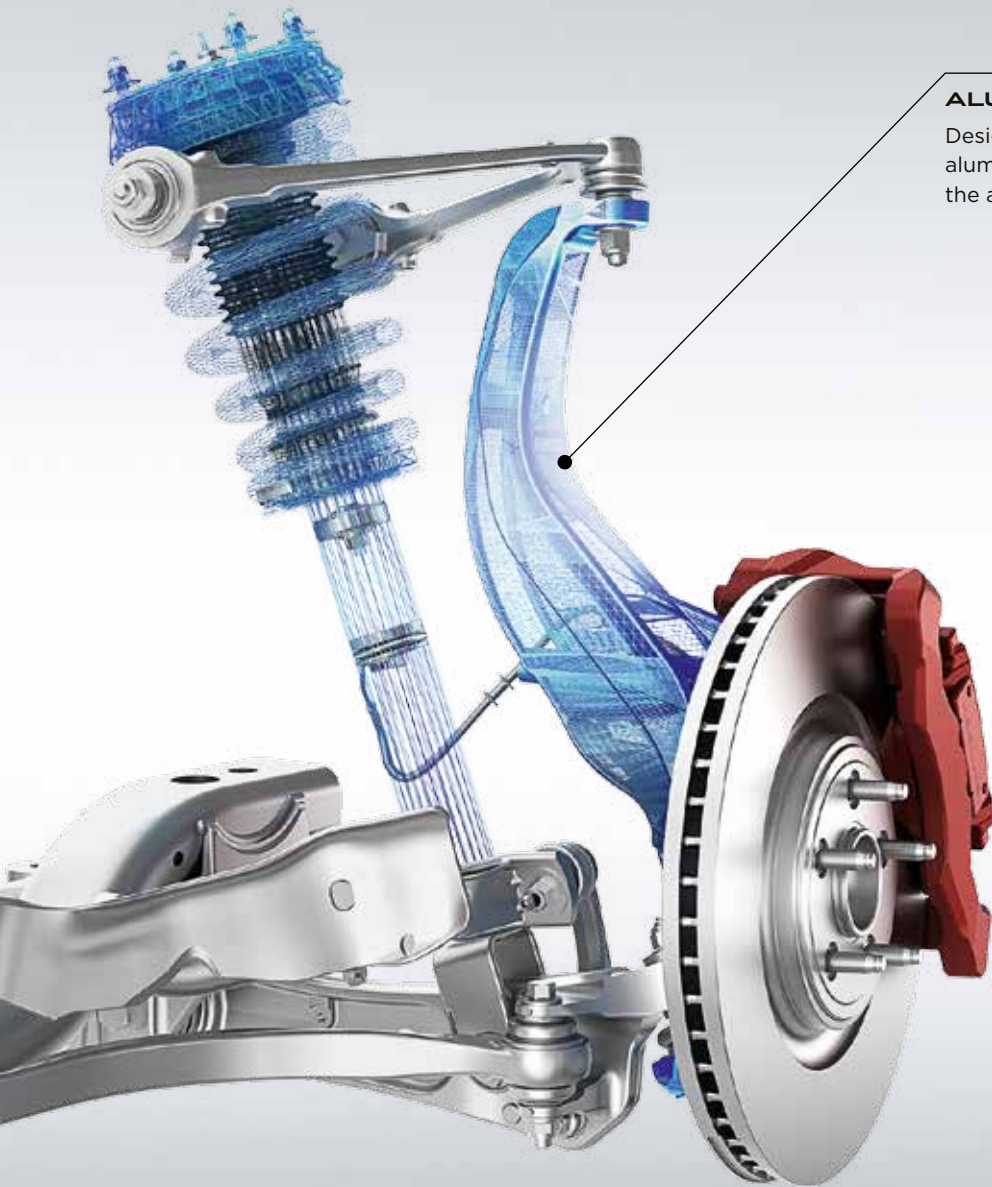

ALUMINUM SUSPENSION KNUCKLES

Designed to optimize stiffness and strength, the lightweight aluminum front and rear suspension knuckles help improve the agility and responsiveness of the F-TYPE.

CHASSIS AND SUSPENSION



COMFORT
AND CONTROL

DYNAMIC
AND REFINED

The aluminum body creates an immensely stable platform from which the forged aluminum double wishbone suspension can control the car. With the damping set-up optimized for the best partnership between dynamics and refinement, it gives the perfect combination of control, agility and feedback.

Standard on the F-TYPE S, F-TYPE S AWD, F-TYPE R and F-TYPE SVR, Adaptive Damping assesses body motion and pitch rates 100 times per second, and adjusts the settings for each damper accordingly. The system enhances control, handling and agility. It also rapidly detects and reacts to critical driving conditions and driver demands. This is achieved with a series of sensors that are placed around the car to monitor the body's vertical movement, pitch and roll rates. The steering wheel position is measured 500 times a second enabling the system to predict the car's movements. The stiffness of each individual damper is then adjusted to help maintain body control, stability and agility.

ADAPTIVE DAMPING

Standard on the F-TYPE S, F-TYPE S AWD, F-TYPE R and F-TYPE SVR, the Adaptive Dynamics system delivers both precise dynamics and a supple, luxurious ride by monitoring wheel position and body movements. The system constantly monitors these conditions and adjusts the dampers to provide the optimum balance between comfort and refinement at all times⁵.

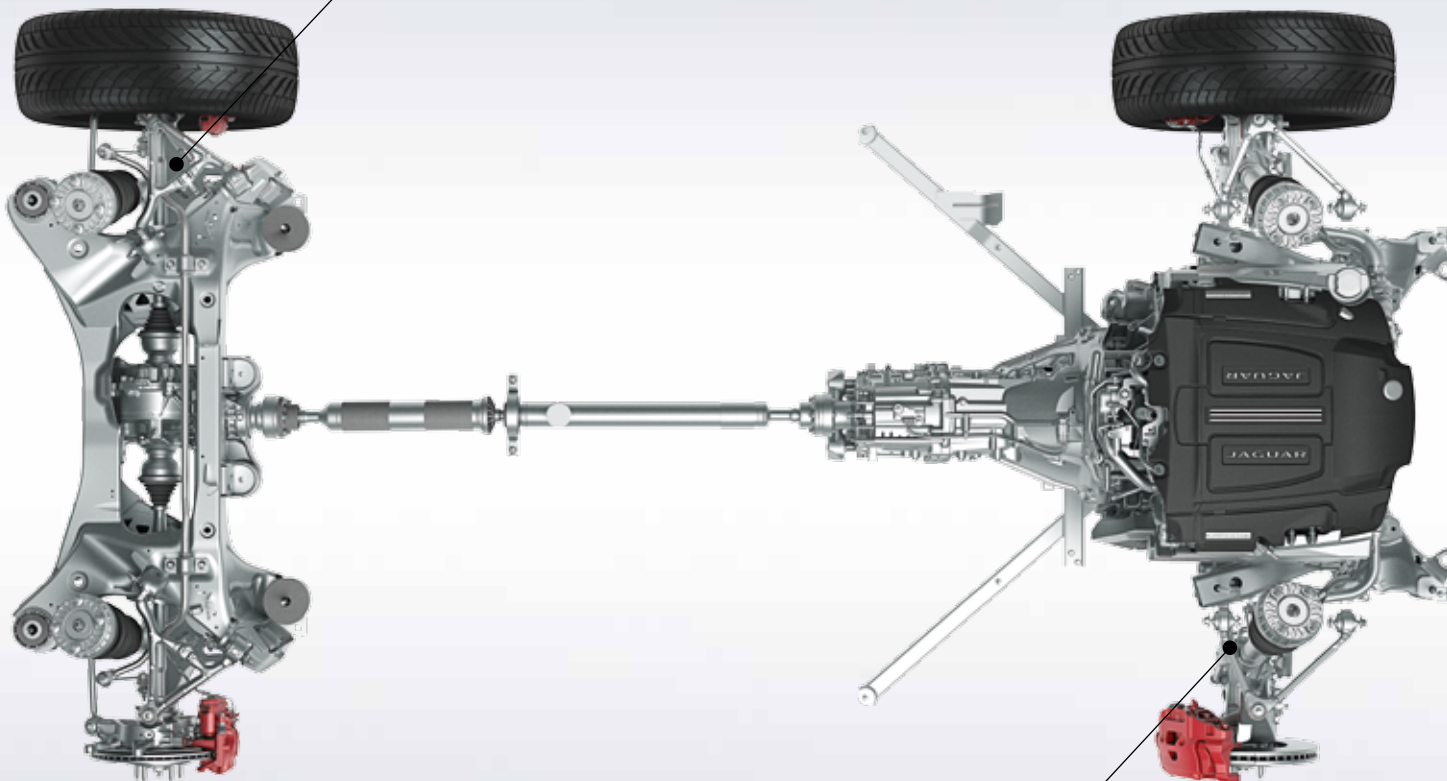

CHASSIS

Considered by Jaguar as the best configuration for a suspension system, the forged aluminum double wishbone design offers precise handling and control.

373 GALLONS

OF RECYCLED WATER PER MINUTE
BLASTED AT EVERY CAR TO ENSURE F-TYPE
IS MONSOON PROOF

10,000,000 HOURS

OF VIRTUAL TESTING, REDUCING OUR IMPACT ON THE
ENVIRONMENT WITH SIGNIFICANT SAVINGS IN RESOURCE,
WASTE, POWER AND FUEL

792,000

VIRTUAL VEHICLES CREATED BEFORE
THE F-TYPE WAS PERFECTED

12,000 MILES

OF EXTREME TRACK TESTING ON GERMANY'S
INFAMOUS NÜRBURGRING RACE TRACK -
EQUIVALENT TO DRIVING HALF WAY AROUND THE WORLD



162°F

DIFFERENCE BETWEEN THE HOTTEST (+122°F)
AND THE COLDEST (-40°F) EXTREME CLIMATE
TESTING ENVIRONMENTS

300 TERABYTES

OF PERFORMANCE DATA GATHERED TO REFINE
EVERY INCH OF THE F-TYPE

TESTED TO THE EXTREME



VIRTUAL
ANALYSIS

REAL WORLD
TRIALS

The F-TYPE first took to the road in the virtual world of Computer Aided Engineering (CAE) systems ensuring that all components underwent extensive development and testing before being committed to the physical testing process. Engineers produced a series of virtual prototypes to realistically simulate the behavior of complex mechanical systems allowing them to analyze multiple variations until the optimum design was achieved. For example, using a technique first used in the aerospace industry, aerodynamic testing took place in a virtual wind tunnel with Computational Fluid Dynamics running on high speed supercomputers. During its virtual life, the F-TYPE completed half a million analyses, requiring 10 million computer processor hours and creating 300TB of data. The CAE development process was one of the key contributing factors in delivering the exhilarating performance and responsiveness of the F-TYPE.

The real world testing to fine tune the set-up took place in specialist facilities and the harshest environments across the globe in temperatures ranging from -40°F to +122°F, and at altitudes of up to 13,123 ft. High-speed stability tests, for example, were conducted at Nardo in southern Italy. The Nordschleife circuit at the Nürburgring in Germany was the perfect location to prove out handling, braking, cooling and durability. Known as the “Green Hell”, and featuring 12.93 miles of track with 73 turns, it is renowned as the most demanding circuit in the world and the ultimate test of both car and driver.

VEHICLE SHOWN: F-TYPE S IN RHODIUM SILVER

DRIVING TECHNOLOGY ADVANCED DRIVING DYNAMICS

> MAXIMIZING AGILITY | **CONTINUOUSLY ADAPTING**

Dynamic Mode revises the vehicle software to further enhance the sporting character⁵ of the F-TYPE. It sharpens the throttle response, increases steering weighting and performs gearshifts more quickly* and at higher engine speeds. It also brings visual drama to the driver as the instrument cluster takes on a red glow. Dynamic Mode enhances your connection with the F-TYPE.

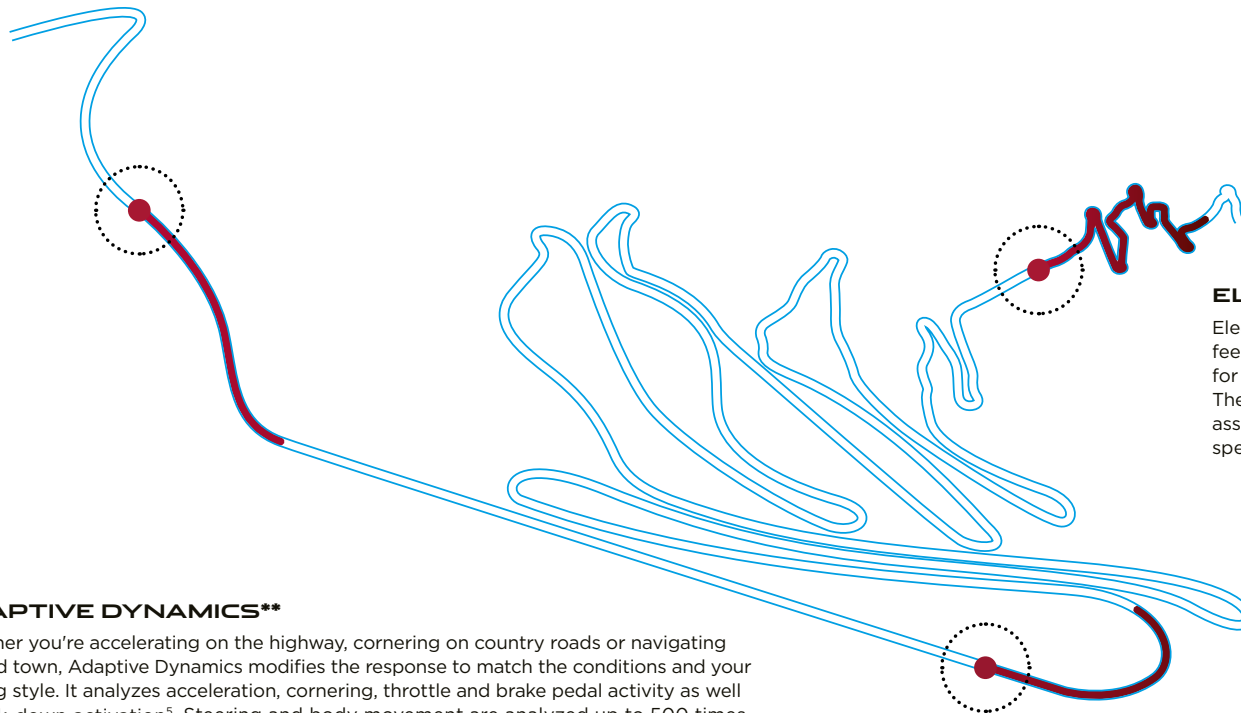

ADAPTIVE DYNAMICS**

Whether you're accelerating on the highway, cornering on country roads or navigating around town, Adaptive Dynamics modifies the response to match the conditions and your driving style. It analyzes acceleration, cornering, throttle and brake pedal activity as well as kick-down activation⁵. Steering and body movement are analyzed up to 500 times a second. Electronically controlled dampers then constantly adjust to optimize the suspension settings and maintain the dynamism and comfort.

ELECTRIC POWER ASSISTED STEERING

Electric Power Assisted Steering (EPAS) offers outstanding feedback, control and it is active on demand - saving power for where you really need it, as well as saving fuel. The sophisticated computer management varies steering assistance as appropriate - increasing assistance for low speed maneuvering and improving feel at higher speeds⁵.

CONFIGURABLE DYNAMICS**

The Configurable Dynamics system allows you to set up the dynamics for throttle mapping, gearbox shift points*, steering and configuring the damper settings to suit your performance driving needs.

*Automatic transmission only.

**Standard on F-TYPE S, F-TYPE R and F-TYPE SVR.

Disclaimers apply. Please see page 120 for further details.





DYNAMIC MODE



CONFIGURABLE
DYNAMICS

QUICKER
GEARSHIFTS



Engaging Dynamic Mode through the toggle switch sharpens throttle response, increases steering weighting and performs gearshifts faster at higher engine speeds⁵. Dynamic Mode is also designed to prevent automatic upshifts when you're driving in Manual Mode*.

F-TYPE S, F-TYPE R and F-TYPE SVR feature our Configurable Dynamics system. This lets you define which characteristics are altered in Dynamic Mode. This option also features the Dynamic-i system which can display G-Force and lap time as well as throttle, steering and brake inputs on the 8-inch Touchscreen.

*Automatic transmissions only.
Disclaimers apply. Please see page 120 for further details.



DRY ROAD CONDITIONS

In normal conditions virtually all torque is distributed to the rear wheels, delivering legendary Jaguar agility and handling.

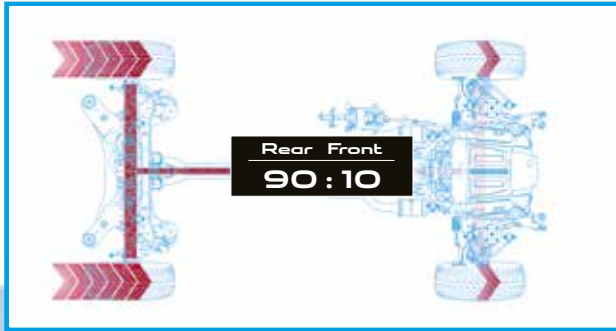

LOW TRACTION CONDITIONS

On slippery surfaces, such as grass and mud, torque can be balanced 50:50 between the front and rear wheels to maximize traction.

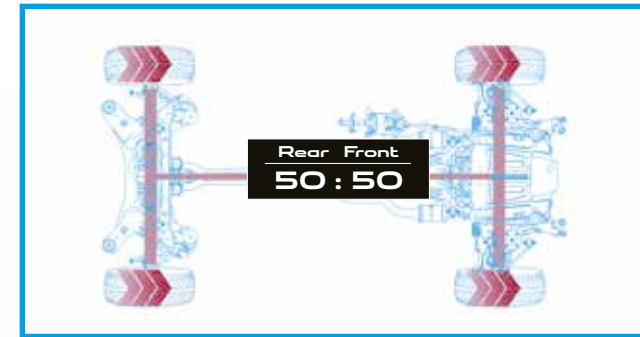

VARIABLE ROAD CONDITIONS

In very extreme conditions, over 90 percent of engine torque can be distributed from the rear wheels to the front wheels to provide optimum grip.

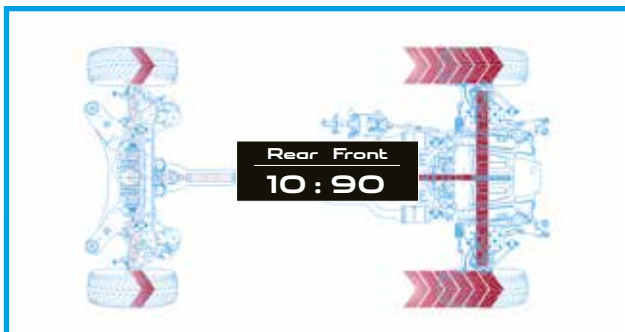

ADVANCED DRIVETRAIN TECHNOLOGY

> ALL WHEEL DRIVE

The F-TYPE All Wheel Drive (AWD) system delivers confident handling on most surfaces. Available with Quickshift automatic transmissions, it makes F-TYPE S AWD, F-TYPE R and F-TYPE SVR one of the most capable sports cars.

Drivetrain technology offers a reduction in weight and an increase in efficiency compared to previous generation systems. The unique Intelligent Driveline Dynamics software features sophisticated algorithms that react intelligently to road conditions for traction on demand. As well as offering a smoother drive, it also uses less fuel and has lower emissions than permanent AWD. Predictive, as well as reactive, the system helps prevent you from losing traction instead of working to regain it⁵.

AWD also offers distinct characteristics between driver-selected modes. Dynamic Mode delivers a more energetic driving experience, with the added assurance of AWD stability. The Rain/Ice/Snow Mode improves control in poor conditions⁵. The result is phenomenal cornering capabilities, providing outstanding levels of performance and control, whatever the road throws at you.

Disclaimers apply. Please see page 120 for further details.



BRAKE PRESSURE
APPLIED TO INSIDE
REAR WHEEL

MORE POWER
DISTRIBUTED TO
OUTER REAR WHEEL

ADDITIONAL ROTATIONAL
FORCE APPLIED AROUND
VEHICLE'S AXIS

TORQUE VECTORING



INCREASED STEERING
PERFORMANCE

ENHANCED
CORNERING CAPABILITY

Torque Vectoring maximizes capability through even the tightest corners. Torque Vectoring technology provides controlled independent braking of the individual inside front and rear wheels to add to the turning forces acting on the car. In most conditions more braking pressure is applied to the rear inside wheel as this supports the most increased cornering capability, while the front inside wheel is braked for greater effectiveness and refinement. The result is reduced understeer for sharper turning and more consistent road holding. Torque Vectoring delivers increased agility and added driver confidence⁵.

On F-TYPE R and F-TYPE SVR, Torque Vectoring works together with the Electronic Active Differential system⁵, complementing each other to optimize traction and cornering ability as well as maximizing steering feel and agility.

VEHICLE SHOWN: F-TYPE R IN POLARIS WHITE FEATURING OPTIONAL BLACK PACKAGE

Disclaimers apply. Please see page 120 for further details.



STABILITY AND CONTROL

> LOW CENTER OF GRAVITY | **GREATER CONTROL AND TRACTION**

The stability systems keep the F-TYPE well-balanced whether you're driving enthusiastically or simply want some reassurance of a car that will remain stable in challenging conditions.

Optimum Weight Distribution: The low center of gravity reduces body roll in corners, while short front and rear overhangs concentrate mass within the wheelbase. Meticulous attention to detail in the design and construction has put the battery, electronic systems, and even the washer bottle, at the rear to give perfect balance. All these factors combine to ensure that the F-TYPE is inherently agile and a real pleasure to drive.

Electronic Active Differential: On F-TYPE R and F-TYPE SVR, the Electronic Active Differential works with the stability, traction and ABS systems to manage torque delivery to each of the rear wheels. Full electronic control of the rear differential lock lets the system apply full locking torque almost instantaneously. The Intelligent Driveline Dynamics (IDD) system works together with the Electronic Active Differential. It helps increase traction and stability, giving full rein to F-TYPE R and F-TYPE SVR towering performance⁵.

MASS MOMENT OF INERTIA

The closer the weight is to the center of the car, the easier it is to turn

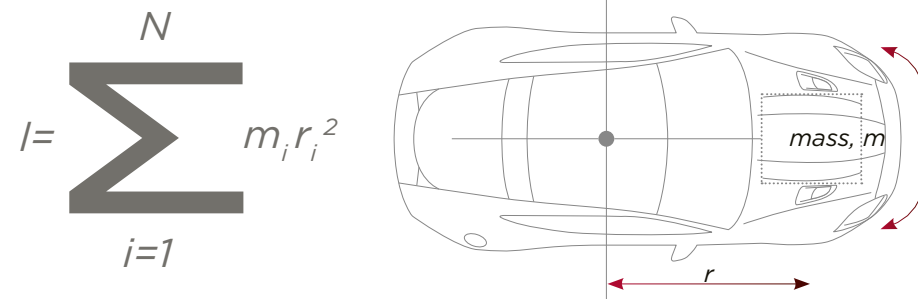

VEHICLE SHOWN: F-TYPE R IN POLARIS WHITE

Disclaimers apply. Please see page 120 for further details.



JAGUAR
CARBON CERAMIC

PERFORMANCE BRAKING SYSTEMS

➤ LIGHTWEIGHT | POWERFUL | RELIABLE

A range of braking systems are available, each one engineered to deliver a confident, progressive feel and consistent high performance. The calipers use aluminum to reduce the unsprung mass of the car, benefiting both handling and ride refinement. Each system features large, ventilated brake discs – up to 398mm in diameter on the Carbon Ceramic system. This large swept area improves braking force as well as providing greater capacity for the discs to absorb and dissipate the heat energy generated during braking.

The Carbon Ceramic Braking system, with its striking yellow monobloc calipers, is optional on F-TYPE S, F-TYPE R and F-TYPE SVR. The most powerful braking system ever fitted to a Jaguar road car, it offers up to 46 lbs of weight saving, further reducing unsprung mass. With greater resistance to fade and wear it delivers high levels of sustained performance in the most demanding conditions.

F-TYPE, F-TYPE PREMIUM
JAGUAR
PERFORMANCE



CALIPERS: SILVER

F-TYPE S
JAGUAR HIGH
PERFORMANCE

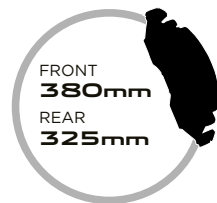

CALIPERS: BLACK (STANDARD)

F-TYPE R AND F-TYPE SVR
JAGUAR SUPER
PERFORMANCE*

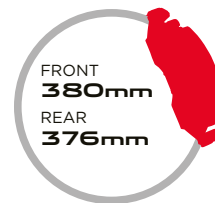

CALIPERS: RED (STANDARD)
BLACK (OPTIONAL)

Optional
F-TYPE S, F-TYPE R
AND F-TYPE SVR
JAGUAR CARBON
CERAMIC**

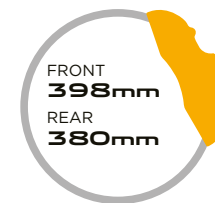

CALIPERS: YELLOW

*Jaguar Super Performance Brakes available as an option on F-TYPE S.

**Carbon Ceramic Brakes available as an option on F-TYPE S automatic models, F-TYPE R and F-TYPE SVR.

INFOTAINMENT JAGUAR INCONTROL® TECHNOLOGIES

ENHANCED CONNECTIVITY

Jaguar InControl® is our suite of advanced technologies that links both you and your F-TYPE to the wider world. Every F-TYPE features the powerful 8 inch Touch-screen infotainment system. This is further enhanced by InControl Remote™, InControl Protect™ and InControl Apps™ which come as standard on all F-TYPE models.

Third Party programs or applications may require an end user license from the supplier.

Do not use Jaguar InControl® features under conditions that will affect your safety or the safety of others. Driving while distracted can result in loss of vehicle control.



STANDARD ON EVERY F-TYPE

8 inch Touch-screen

5 inch instrument panel display with analog dials

Meridian™ Surround Sound System (770W)

SiriusXM® Satellite Radio

iPod®, USB, Bluetooth® and AUX connections

Navigation²



InControl Protect™ includes SOS Emergency Call and Optimized Roadside Assistance, which can automatically bring the relevant services to your exact location when needed.

InControl Remote™ is a multi-function app that allows you to monitor as well as interact with your F-TYPE from your smartphone.

InControl Apps™ connects your smartphone with the Touch-screen in your vehicle, meaning you can stay safely connected to your smartphone even while in the car.



Explore Jaguar InControl® at JAGUARUSA.COM

Please consult your local Jaguar Retailer for further details.





ADVANCED INFOTAINMENT AS STANDARD

The multimedia system is the hub for connectivity, control and entertainment in the F-TYPE. The key features are:

8-inch Touch-screen at the heart of the center console. Clear graphical interface responds directly to touch for quick control.

Navigation guidance makes planning journeys and following routes easy, thanks to turn-by-turn voice guidance and junction view.

Bluetooth phone connectivity allows you to link and control your smartphone via the Touch-screen either for phone calls or music playback – simple, easy and wire-free.

Access a world of music thanks to SiriusXM® Satellite Radio, as well as iPod, USB and AUX connections.

Precise climate control is available via the Touch-screen. Adjust temperature levels, direction and intensity of airflow.

InControl Apps™ connects your smartphone with the Touch-screen in your vehicle, meaning you can stay safely connected to your smartphone even whilst in the car. InControl Apps™ enables you to control compatible apps on your Touch-screen, ensuring the safe and convenient use of apps that have been optimised specifically for use within your vehicle.

Simply download InControl Apps™ to your smartphone. You can then connect your smartphone via a dedicated USB port to display compatible apps on the Touch-screen in the center console.

Standard on all F-TYPE models, **InControl Remote & Protect™** is a package of technologies and applications that takes your connectivity to the next level.

SOS Emergency Call automatically sends your location to, and puts you in contact with, the emergency services if the airbags deploy following an accident.

Optimized Roadside Assistance puts you in contact with Roadside Assistance at the touch of a button and transmits key vehicle information, location, and certain diagnostics for a rapid response.

InControl Remote™ is a multi-function app that allows you to monitor as well as interact with your F-TYPE from your smartphone. It gives you vital information and statistics about your car, including its location and whether any doors and windows are open or unlocked. The app can start the engine to pre-condition the climate, lock and unlock the car, locate your F-TYPE on a map or by using the beep and flash function.



Explore Jaguar InControl® at JAGUARUSA.COM

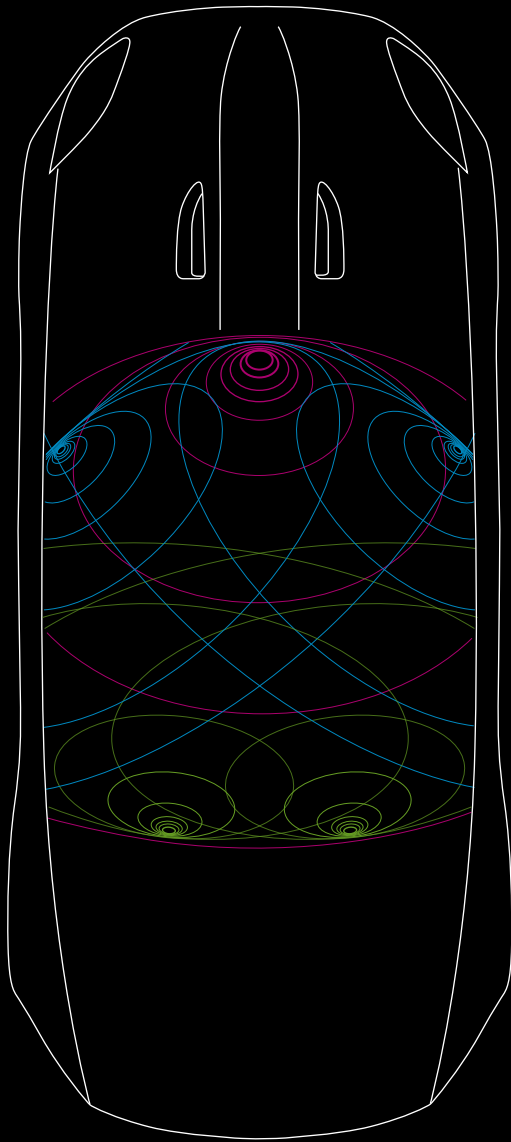

AUDIO

MERIDIAN™ SURROUND SOUND SYSTEM

The superb **Meridian Surround Sound System**, with its **770 watts** of power and 12 speakers – including deep-bass subwoofers, is standard on all F-TYPE models and brings the cockpit to life with incredible, rich sound and amazing audio reproduction.

It features advanced technology, such as Digital Signal Processing (DSP), to optimize every element of the system and uses Meridian's advanced Cabin Correction algorithm to tailor the music experience to the precise acoustics of the vehicle's interior.

This state-of-the-art system also features Dynamic Volume Control, which compensates for changes in sound levels within the car to ensure that audio quality is always consistent – top up or down; as well as Meridian Trifield technology to deliver an authentic and consistent music experience within the cabin.



-  Holographic Center Image
-  Door Waves: Tweeter, Midrange and Bass
-  Surround Sound Waves

Diagram representative of Meridian 770W Surround Sound System.



MERIDIAN



770

WATTS

12

SPEAKERS

16

AMPLIFIER CHANNELS

MERIDIAN™ SURROUND SOUND SYSTEM

Dynamic Volume Control

770 watts

12 speakers

16 channel class D DSP amplifier

Audyssey MultEQ Audio Equalisation

7.1 Surround Sound

Meridian Trifield Technology

'Trifield' and the 'three fields' device are trademarks of Trifield Productions Ltd.

VEHICLE SHOWN: F-TYPE S IN CALDERA RED WITH OPTIONAL FEATURES FITTED

ASSISTANCE AND EFFICIENCY

ADVANCED DRIVER ASSISTANCE



- ① **REVERSE TRAFFIC DETECTION**
This optional system helps you reverse out of a parking space. Sensors detect approaching vehicles from either direction and warnings are audible and displayed on the Touch-screen.



- ② **CLOSING VEHICLE SENSING WITH BLIND SPOT MONITOR**
Optional Closing Vehicle Sensing uses sophisticated sensors to help warn if faster moving vehicles are approaching from behind. Blind Spot Monitoring is designed to provide an extra alert should the system detect a vehicle entering a pre-defined blind spot.



- ③ **BI-FUNCTION HID XENON HEADLAMPS**
These deliver an intense white light for both main and dipped beam in a single unit for improved night vision.



- ④ **ADAPTIVE FRONT LIGHTING***
This system measures the speed of the car and angle of the steering wheel, swivelling the headlamps by up to 14 degrees out and up to 7 degrees in, for improved visibility during cornering.

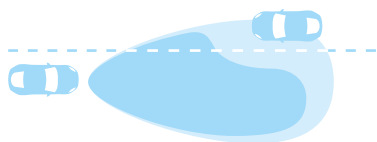

- ⑤ **INTELLIGENT HIGH BEAM***
The Intelligent High Beam system automatically switches between low and high beam when necessary, using a sensor mounted at the front of the rear view mirror.



- ⑥ **LED REAR LAMPS**
LED technology creates the distinctive design of the rear lamps. They illuminate to full brightness faster than conventional bulbs, and are designed to provide drivers behind you more time to react.



- ⑦ **EMERGENCY BRAKE ASSIST**
If the brakes are applied rapidly, this system is designed to boost braking force to the maximum for shorter stopping distances. It can also help retain greater steering control in unexpected situations.

*Optional feature on F-TYPE base derivative.
These features are not a substitute for driving safely with due care and attention and will not function under all circumstances, speeds, weather and road conditions, etc. Driver should not assume that these features will correct errors of judgment in driving. Please consult the owner's manual or your local Jaguar Retailer for more details.

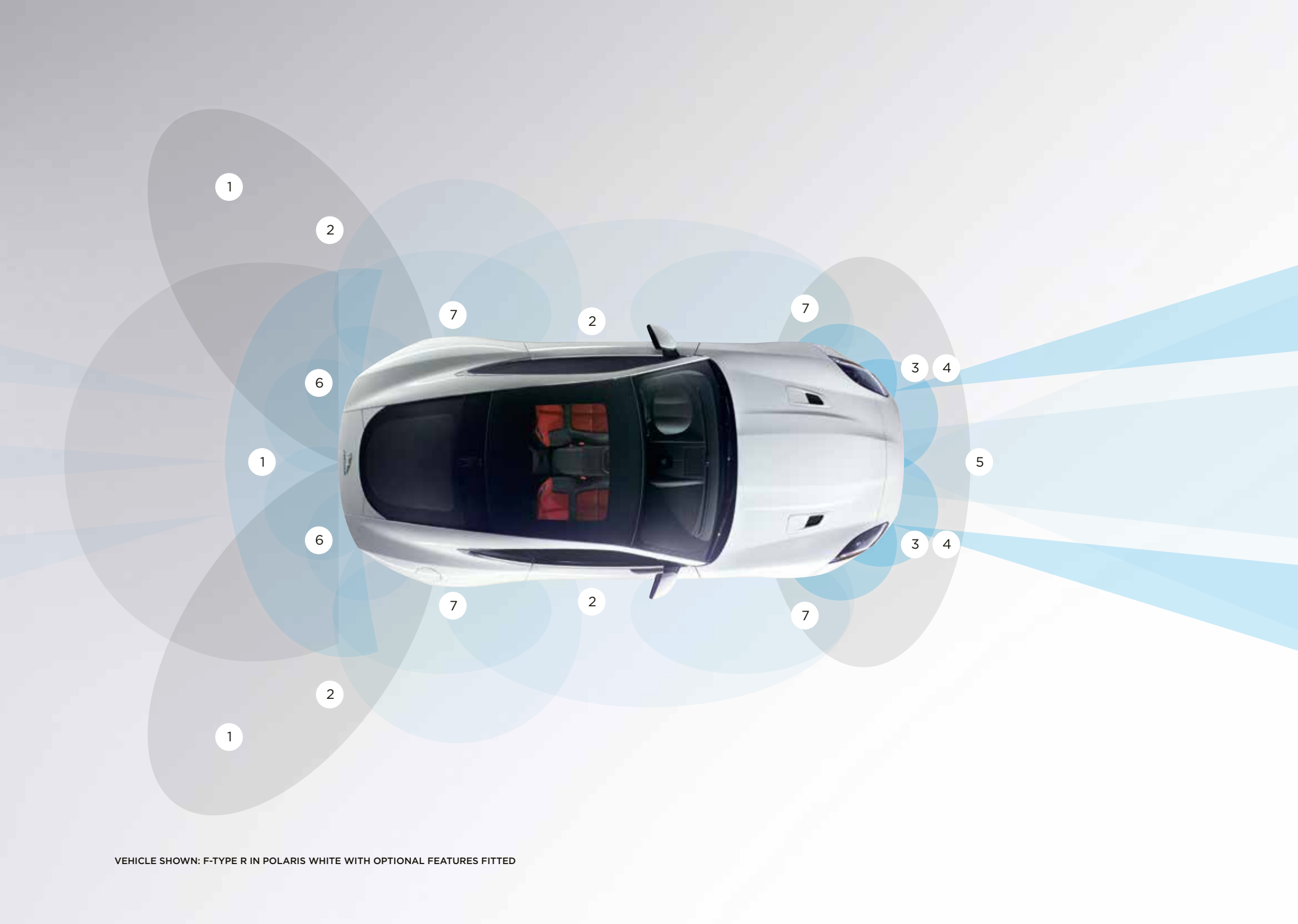

VEHICLE SHOWN: F-TYPE R IN POLARIS WHITE WITH OPTIONAL FEATURES FITTED

EFFICIENT TECHNOLOGIES



STOP/START TECHNOLOGY

LIGHTWEIGHT MATERIALS

The F-TYPE uses a range of technologies to help reduce fuel consumption and CO₂ emissions, all while staying true to the dynamic nature of Jaguar.



STOP/START TECHNOLOGY

The F-TYPE engines are available with Intelligent Stop/Start. The system shuts down the engine when you come to a complete halt and restarts the engine immediately when required. It helps save fuel, especially during city driving.



ELECTRIC POWER ASSISTED STEERING (EPAS)

The next generation Electric Power Assisted Steering (EPAS) offers outstanding feedback, control and immediate power assistance. Electrically driven, it's only active on demand which saves fuel.



SUSTAINABLE CONSTRUCTION

The aluminum alloy used for much of the F-TYPE construction is from a high level of recycled aluminum. Using significantly less energy than primary aluminum to produce, it minimizes the environmental impact.



ADVANCED AERODYNAMICS

Aerodynamic performance is seamlessly integrated into the design for low levels of lift and excellent stability at high speeds. This has the positive effect of reducing the fuel consumption of the F-TYPE.



R IS INTENSITY. IT PROVIDES MORE. MORE POWER. MORE DYNAMIC CAPABILITY. MORE THRILLS. F-TYPE R IS THE SPORTS CAR THAT IS MORE HONED, SENSUOUS AND EXCITING.







PERFORMANCE

 **5.0 LITER V8 550HP ENGINE** | **0-60MPH IN 3.9 SECONDS**

F-TYPE R is powered by the 5.0 V8 550HP supercharged engine with 502 lb-ft of torque taking you from 0-60mph from 3.9 seconds*. With finely balanced power output and power-to-weight ratios, the extremely rigid bodyshell of the F-TYPE R provides the definitive platform for suspension enhancements that harness every ounce of power on hand. Now combined with All Wheel Drive (AWD)⁵, its synthesis of power, performance and handling is ready to take on almost any road conditions.

*ALWAYS FOLLOW LOCAL SPEED LIMITS.

VEHICLE SHOWN PREVIOUS PAGE: F-TYPE R IN STORM GREY FEATURING CARBON CERAMIC BRAKING SYSTEM
VEHICLE SHOWN THIS PAGE: F-TYPE R IN STORM GREY FEATURING CARBON CERAMIC BRAKING SYSTEM

Disclaimers apply. Please see page 120 for further details.

INTERIOR



PREMIUM LEATHER INTERIOR

R EMBOSSED HEADRESTS

The interior dials of the F-TYPE R up the intensity of the 1+1 experience. The R theme gives the car a unique personality and includes Dark Linear Aluminum on the center console finishers. Enjoy Premium Leather with twin needle stitching and, for more lateral support during more enthusiastic driving, body-hugging Performance seats with embossed R logo on the headrest. Take complete control with the 3-spoke flat-bottomed leather steering wheel with R logo.

VEHICLE SHOWN: F-TYPE R FEATURING STANDARD PERFORMANCE SEATS IN JET AND IVORY DUOTONE





HOW CAN YOU IMPROVE ON THE TECHNICAL EXCELLENCE AND INTENSE THRILLS OF F-TYPE R? SVR IS THE FASTEST F-TYPE EVER. EVERY DETAIL DELIVERS ENHANCED PERFORMANCE. OVER 100 REFINEMENTS, WEIGHT REDUCTIONS AND TECHNICAL REINVENTIONS HAVE CREATED AN EXHILARATING SPORTS CAR THAT IS PURE JAGUAR.







THE CONCEPT OF SVR



STATE-OF-THE-ART MATERIALS

ADVANCED AERODYNAMICS

The SVR is F-TYPE honed beyond perfection. Its state-of-the-art materials and advanced aerodynamic design push the F-TYPE beyond the extraordinary. Delivering supreme performance, ride and handling, the car creates once-in-a-lifetime driving experiences – every day. Its exceptional powertrain makes the SVR our fastest production car ever. The SVR is our ultimate sports car.







SPECIAL VEHICLE OPERATIONS



CENTER
OF EXCELLENCE

0-60MPH
IN 3.5 SECONDS

Based at a new Formula 1-inspired manufacturing facility, complete with customer commissioning suite, Special Vehicle Operations (SVO) is the center of excellence and has been established to enable our most discerning customers to indulge their passion for Jaguar. The SVR is designed and engineered at SVO where our highly skilled engineers and aerodynamics experts have scrutinized every possible component to maximize the performance of the SVR.

The lightweight All Wheel Drive system, with Intelligent Driveline Dynamics⁵, delivers its power with efficiency and control. The engine has been recalibrated. The 5.0 liter V8 unit's twin vortex supercharger eliminates drag and surge for responsive performance at all engine speeds. 575HP and torque of 516 lb-ft is maximized by a power-to-weight ratio of 6.5 lbs* per HP. Hold tight - it will take you from 0-60 mph from 3.5 seconds and on to a top speed of 200 mph*⁸. But it is about more than numbers, more than just a machine. Jaguar makes performance an art. The SVR is our latest masterpiece.



SPECIAL VEHICLE
OPERATIONS

*Coupe only.

VEHICLE SHOWN PREVIOUS PAGE (LEFT) AND ONE PRECEDING: F-TYPE SVR IN FIRESAND FEATURING CARBON CERAMIC BRAKING SYSTEM
VEHICLE SHOWN PREVIOUS PAGE (RIGHT) AND THIS PAGE: F-TYPE SVR IN AMMONITE GREY WITH OPTIONAL EQUIPMENT FITTED

Disclaimers apply. Please see page 120 for further details.



AERODYNAMICS



**MAXIMIZED
CAPABILITY**

**ADJUSTABLE
DOWNFORCE**

The performance is not expressed by its exterior design: it is created by it. Form follows function in every swooping curve and finely drawn line. Each unique styling element, down to the smallest, subtle detail, improves the SVR. Its advanced aerodynamic design offers less drag and higher levels of downforce. As a result the SVR slices cleanly through the air, achieving rapid acceleration and effortlessly efficient cruising. Strong downforce improves stability and handling, road holding and dynamic capability.

FRONT INTAKES AND SPLITTER

Unique large lower bumper intakes maximize airflow for cooling of both the engine and brakes for improved performance. A precision splitter designed specially for the SVR directs airflow into the car for optimum cooling. It also creates downforce at the front of the car to balance the rear wing.

HOOD LOUVRES AND SIDE POWER VENTS

Uniquely shaped louvres maximize airflow through the engine bay. This aids cooling, so the engine can operate at the highest level. Air from the wheel housing is released through side power vents which manage airflow around the wheel arch to minimize drag and improve the efficiency of the SVR.

ENHANCED COOLING

The cooling system has been enhanced with significant improvements to airflow. To achieve this, the auxiliary radiator has been relocated, while the bumper beam profile and inlet trumpet size have been reduced. This increases the full performance envelope on the SVR for greater endurance in extreme driving situations.



AERODYNAMIC WING

The aerodynamic wing is integral to the enhanced performance of the SVR. Compared with the standard F-TYPE Coupe rear wing, SVR produces more downforce but crucially less drag. The wing is more elevated and wider than the standard F-TYPE R Coupe spoiler, enabling it to act over the whole width of the car rather than just the width of the trunk lid.

Air passes both over and under the wing, allowing Bernoulli's principle to act in the car's favor - faster moving air underneath the wing is at a lower pressure than that passing over the top, resulting in additional downforce.

The SVR wing operates in two different positions:

On the F-TYPE SVR Coupe the aerodynamic wing deploys at 70 mph⁸ and stows at 50 mph.

On the F-TYPE SVR Convertible the aerodynamic wing deploys at 60 mph⁸ and stows at 40 mph.

DEPLOYED

When the SVR wing is deployed it increases downforce for greater stability and improved handling at top speed. In this position the wing gives a drag coefficient reduction of 2.5 percent and a lift coefficient reduction of 15 percent.

STOWED

For maximum top speed (V-Max), the wing is stowed to reduce drag. It works in conjunction with the front spoiler and other aerodynamic enhancements to bring a drag coefficient improvement of 7.5 percent and lift coefficient reduction of 45 percent.

V-MAX

In order to achieve 200 mph^{*8} you must consciously prepare your SVR. Select 'Dynamic Mode' and press the deployable aerodynamic wing switch for 3 seconds to enable V-Max mode. While active, a permanent symbol appears on the instrument cluster. In this mode the spoiler remains stowed at all speeds keeping drag to a minimum.

REAR UNDERFLOOR AND DIFFUSER

The smooth rear underfloor reduces drag, whilst the rear diffuser works with the rear underfloor to manage airflow, adding to the stability of the SVR.

*Coupe only.
Disclaimers apply. Please see page 120 for further details.



LIGHTWEIGHT TECHNOLOGIES



WEIGHT SAVING

INNOVATIVE DESIGN

Weight is the enemy of performance. So we designed SVR to be as lean as possible. Every pound has a reason to be there. Every ounce saved gives you more rapid acceleration, more agile handling and sharper braking. Yet the interior still offers comfort and luxury in equal measures. The SVR has the capability to make performance effortlessly enjoyable.

FORGED ALLOY WHEELS

The bespoke Forged Alloy Wheels are fitted with unique Pirelli P ZERO™ tires. Its rear tires are 10mm wider than standard F-TYPE tires, for improved handling and grip. While the striking Forged Alloys offer a 30.4 lbs overall weight saving.

CERAMIC BRAKES

The optional CCM Brakes save up to 46 lbs of weight compared with non-ceramic alternatives.

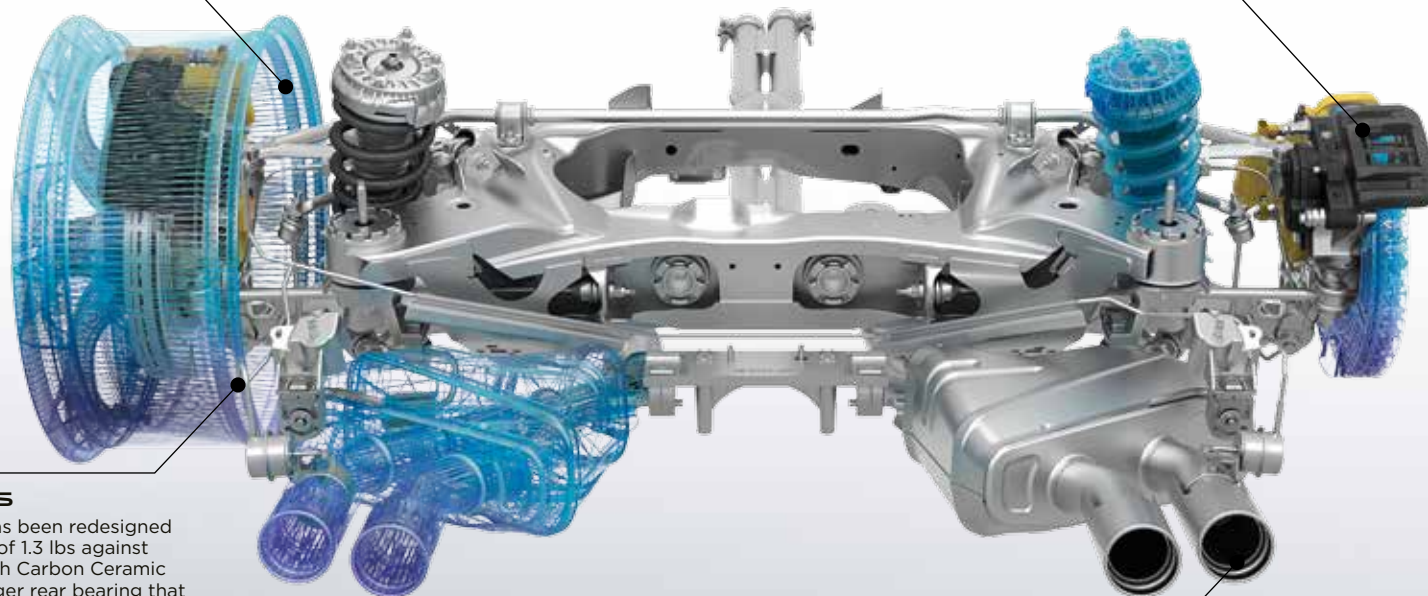

REAR KNUCKLES

The suspension system has been redesigned enabling a weight saving of 1.3 lbs against conventional knuckles with Carbon Ceramic brakes. The SVR has a larger rear bearing that contributes towards an increased stiffness of up to 37 percent over conventional F-TYPE knuckles. This enables the car to handle even higher lateral G-forces.

TITANIUM EXHAUST

The lightweight Titanium and Inconel® exhaust system saves 35.2 lbs. With its SVR badged tailpipes, it not only looks unique, it sounds unique - SVR is recognizable by the distinctive rumble of its exhaust.



INTERIOR

 **UNIQUE DETAILS** | **SPORTING CRAFTSMANSHIP**

Just as no detail of the SVR engineering and exterior design has been overlooked, its interior is testament to the SVO division's attention to detail. The moment you open the door, the SVR treadplate shows that you are entering a special space.

Exclusive materials are everywhere you look, from fine contrast stitching to ultra-modern finishes that create a sense of total luxury. The SVR badged steering wheel with larger aluminum anodised shifter paddles offers the perfect connection to the road and the quilted Performance seats offer comfort and support while you enjoy the dynamic drive.

VEHICLE SHOWN: F-TYPE SVR FEATURING SIENNA TAN PERFORMANCE SEATS WITH CIRRUS STITCH



PERSONALIZATION THE F-TYPE - YOUR CHOICE



Configure your vehicle at JAGUARUSA.COM



CHOOSE YOUR ENGINE

Page 76

Select a powerful F-TYPE engine to suit your driving style.

CHOOSE YOUR MODEL & PACKAGES

Page 78

Compare the wealth of standard features and options on F-TYPE models.

CHOOSE YOUR COLOR

Page 90

Express your individuality with one of the stunning F-TYPE exterior colors.

CHOOSE YOUR WHEELS

Page 92

Complement the stunning style of the F-TYPE with a set of beautifully designed wheels.

CHOOSE YOUR INTERIOR

Page 94

There's a wide selection of premium materials, leathers, veneers and finishes for every personal taste.

CHOOSE YOUR JAGUAR ACCESSORIES

Page 108

Really make it yours by adding style, practicality and versatility with official F-TYPE Accessories from your local Jaguar Retailer.

1 CHOOSE YOUR ENGINE

 Configure your vehicle at JAGUARUSA.COM

> V6 ENGINES

3.0 LITER V6 SUPERCHARGED GAS [340HP]

MAXIMUM POWER 340HP
MAXIMUM TORQUE 332 lb.ft
ACCELERATION 0-60 mph Manual 5.5 seconds / Automatic 5.1 seconds
TOP SPEED 161 mph
F-TYPE, F-TYPE PREMIUM

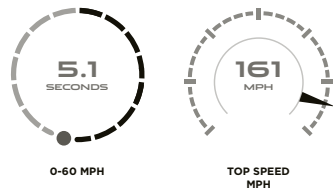

3.0 LITER V6 SUPERCHARGED GAS [380HP]

MAXIMUM POWER 380HP
MAXIMUM TORQUE 339 lb.ft
ACCELERATION 0-60 mph Manual 5.3 seconds / Automatic 4.8 seconds
TOP SPEED 171 mph
F-TYPE S

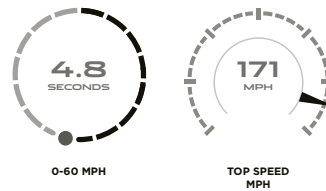

3.0 LITER V6 SUPERCHARGED GAS [380HP] AWD

MAXIMUM POWER 380HP
MAXIMUM TORQUE 339 lb.ft
ACCELERATION 0-60 mph 4.9 seconds
TOP SPEED 171 mph
F-TYPE S AWD

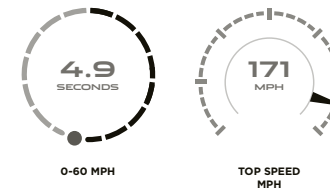

*Coupe only.
Always follow local speed limits.

> V8 ENGINES

5.0 LITER V8

SUPERCHARGED GAS [550HP] AWD

MAXIMUM POWER 550HP
MAXIMUM TORQUE 502 lb.ft
ACCELERATION 0-60 mph 3.9 seconds
TOP SPEED 186 mph

F-TYPE R

5.0 LITER V8

SUPERCHARGED GAS [575HP] AWD

MAXIMUM POWER 575HP
MAXIMUM TORQUE 516 lb.ft
ACCELERATION 0-60 mph 3.5 seconds
TOP SPEED 200 mph*

F-TYPE SVR

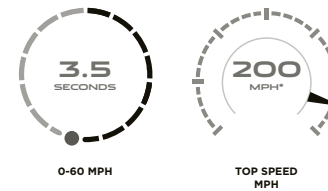
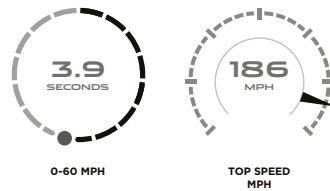

2 CHOOSE YOUR MODEL & PACKAGES

 Configure your vehicle at JAGUARUSA.COM

> REAR WHEEL DRIVE [RWD] COUPE AND CONVERTIBLE



F-TYPE

KEY FEATURES

Jaguar Performance Braking System with Silver calipers
Sports suspension
Sports Exhaust with center mounted twin exhaust pipes
18" Vela alloy wheels
Sport-style seats with Leather and Suedecloth facings
3-spoke leather steering wheel with Black gearshift paddles (automatic only)
Light Hex Aluminum console finisher
Meridian™ Surround Sound System (770W)
SiriusXM® Satellite Radio
Navigation
Available with Quickshift 8-speed automatic or 6-speed manual transmission



F-TYPE PREMIUM

KEY FEATURES (IN ADDITION TO F-TYPE)

Jaguar Smart Key™ with Keyless Entry
Adaptive Front Lighting (AFL) with Cornering Lamps
Intelligent High Beam
Sport-style 14-way seats, power adjustable, driver and passenger
3-position seat, door mirror and steering column memory
Panoramic Roof (Coupe models)
Power fold exterior mirrors
Available with Quickshift 8-speed automatic or 6-speed manual transmission



F-TYPE S

KEY FEATURES (IN ADDITION TO F-TYPE PREMIUM)

Jaguar High Performance Braking System with Black calipers
Sports suspension with Adaptive Dynamics⁵
Switchable Active Sport Exhaust
19" Propeller alloy wheels
Configurable Dynamics System
Limited Slip Differential⁵
3-spoke flat-bottomed leather steering wheel with Ignis gearshift paddles (automatic only)
Dark Hex Aluminum console finisher with 'S' graphic
Configurable Ambient Interior Lighting with selectable palette
Metallic Foot Pedals
Available with Quickshift 8-speed automatic or 6-speed manual transmission

Disclaimers apply. Please see page 120 for further details.

> ALL WHEEL DRIVE [AWD] COUPE AND CONVERTIBLE



F-TYPE S AWD

KEY FEATURES (IN ADDITION TO F-TYPE S)

All Wheel Drive System⁵
Intelligent Driveline Dynamics⁵
'AWD' hood with Body colored vents
19" Volution Silver alloy wheels
Body colored extended side sills, aero blades and rear venturi
Available with Quickshift 8-speed automatic transmission



F-TYPE R

KEY FEATURES (IN ADDITION TO F-TYPE S AWD)

Jaguar Super Performance Braking System with Red calipers
Switchable Active Sports Exhaust with quad exhaust pipes
20" Gyrodyne Silver alloy wheels
Electronic Active Differential with Torque Vectoring
Performance seats with Premium leather facings and 'R' embossing
3-spoke flat-bottomed leather 'R' steering wheel
Dark Linear Aluminum console finisher with 'R' graphic
Auto dimming exterior mirrors
Dual-zone climate control
Heated seats and steering wheel
Garage door/entry gate opener
Wind Deflector (Convertible only)
Rear parking sensors
Gloss Black Rollover Protection Bars
Available with Quickshift 8-speed automatic transmission



F-TYPE SVR

KEY FEATURES (IN ADDITION TO F-TYPE R)

Redesigned aerodynamics
Carbon Fiber Aerodynamic Wing
Lightweight Titanium and Inconel® Exhaust
20" Coriolis Technical Grey forged alloy wheels
Quilted Performance seats with Premium Leather facings and 'SVR' embossing
3-spoke leather 'SVR' steering wheel with Aluminum gearshift paddles and twin needle contrast stitching
Dark Brushed Aluminum console finisher with 'SVR' graphic
Suedecloth Upper Environment
Front parking sensors
Reverse Park Camera
Blind Spot Monitor and Reverse Traffic Detection
Available with Quickshift 8-speed automatic transmission

2 CHOOSE YOUR MODEL & PACKAGES

⚙️ Configure your vehicle at JAGUARUSA.COM

> ROOF STYLES

The F-TYPE offers a range of different roofs to suit your own personal style. Each delivering their own distinctive characteristics, they provide a powerful expression of individual flair both inside the cabin and to the outside world.



ALUMINUM ROOF*

For the pure Coupe look, the aluminum roof is as strong and lightweight as the rest of the vehicle. It provides the ideal complement in color, style and line to the powerful F-TYPE profile. The aluminum roof expresses F-TYPE in its clearest sports car form.



PANORAMIC GLASS ROOF

Introducing even more natural light and airiness to the interior, a full width panoramic glass roof is **standard on the F-TYPE Premium, F-TYPE S, F-TYPE R and F-TYPE SVR Coupe models**. For increased seclusion, should it be required, the roof features a manually sliding 'black-out' blind, which can screen the occupants from up to 99 percent of the incoming light.



CARBON FIBER ROOF

With optional Carbon Fiber outer and inner panels bonded together to create a strong yet light roof structure. It features Carbon Fiber weave visible through a deep, high-grade lacquered finish.



FABRIC ROOF

The lightweight fabric roof of the F-TYPE Convertible is acoustically enhanced with composite fabric to reduce noise and features a flush fitting heated glass rear window. The roof can be raised or lowered in just 12 seconds and operated fully automatically at speeds of up to 30mph.

*Aluminum roof is only available with base F-TYPE derivative.
VEHICLES SHOWN: F-TYPE R IN POLARIS WHITE

CONVERTIBLE ROOF COLORS

STANDARD

Jet

OPTIONAL

Grey

Red

Beige

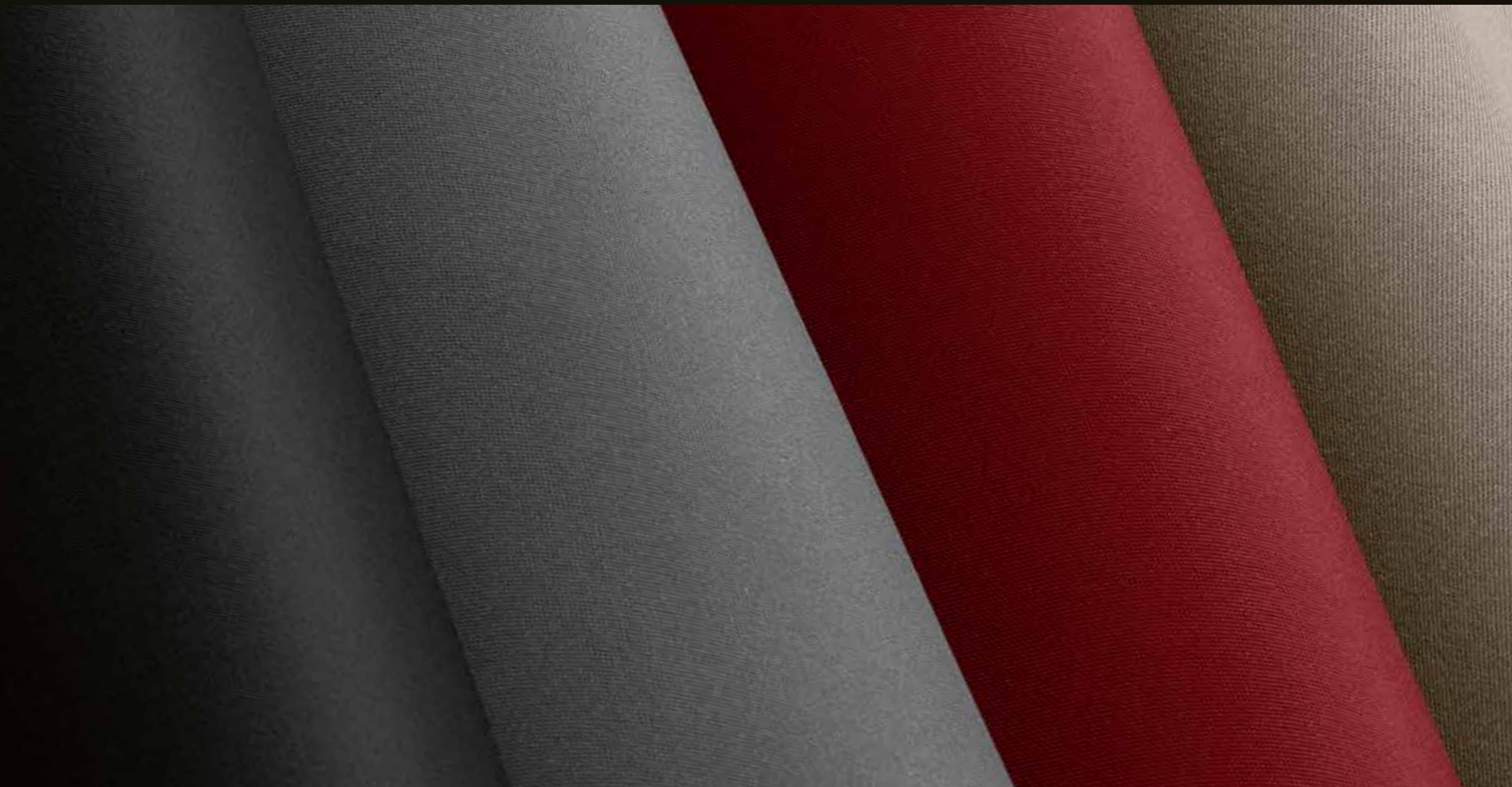

2 CHOOSE YOUR MODEL & PACKAGES

 Configure your vehicle at JAGUARUSA.COM

KEY STANDARD & OPTIONAL FEATURES

TRANSMISSION, STEERING & DYNAMIC FEATURES

	F-TYPE	F-TYPE PREMIUM	F-TYPE S	F-TYPE R	F-TYPE SVR
Eight-speed ZF automatic transmission with 'QuickShift'	●Auto	●Auto	●Auto	●	●
SportShift selector in center console	●Auto	●Auto	●Auto	●	●
Steering wheel-mounted shift paddles	Black	●Auto	—	—	—
	Ignis Orange	—	—	●Auto	—
	Silver	—	—	—	●
	Metallic	—	—	—	—
Six-speed ZF manual transmission	●Man	●Man	●Man	—	—

SUSPENSION

Sport Suspension	●	●	—	—	—
Sport Suspension with Adaptive Dynamics	—	—	●	●	●

BRAKES

4-wheel ventilated disc brakes	●	●	●	●	●
Performance Braking System - 355mm front / 325mm rear rotors with Silver calipers	●	●	—	—	—
High Performance Braking System - 380mm front / 325mm rear rotors with Black calipers	—	—	●	—	—
Super Performance Braking System - 380mm front / 376mm rear rotors with Black calipers	—	—	—	○	—
Super Performance Braking System - 380mm front / 376mm rear rotors with Red calipers	—	—	—	○	●
Carbon Ceramic Matrix (CCM) Braking System - 398mm front / 380mm rear rotors with Yellow calipers	—	—	P11 Auto	P11	P11
Antilock Braking System (ABS)	●	●	●	●	●
Emergency Brake Assist (EBA) ⁵	●	●	●	●	●
Electronic Brake Force Distribution (EBD)	●	●	●	●	●
Electronic Parking Brake (EPB)	●	●	●	●	●

● Standard ○ Optional — Not available

P1 Premium + Vision Package P2 Climate Package P3 Vision Package P4 Extended Leather Package P5 Extended Leather Package - Upper Environment P6 Design Package P7 Black Package P8 Design + Black Package P9 Exterior Carbon Fiber Package P10 Interior Black Package P11 Carbon Ceramic Braking System P12 Super Performance Braking Package P13 Suedecloth Interior Package P14 Red Leather Interior Package

Disclaimers apply. Please see page 120 for further details.

CHASSIS CONTROL SYSTEMS

	F-TYPE	F-TYPE PREMIUM	F-TYPE S	F-TYPE R	F-TYPE SVR
Dynamic Stability Control (DSC)	●	●	●	●	●
Rain/Ice/Snow Mode ⁵	●	●	●	●	●
Open Differential	●	●	—	—	—
Mechanical Limited Slip Differential	—	—	●	—	—
Electronic Active Differential	—	—	—	●	●
Torque Vectoring by Braking	—	—	P12	●	●
Dynamic Mode ⁵	●	●	—	—	—
Configurable Dynamic Mode ⁵	—	—	●	●	●

STEERING

Electric Power Assisted rack-and-pinion Steering (EPAS)	●	●	●	●	●
---	---	---	---	---	---

EXHAUST

Sport Exhaust	●Auto	●Auto	—	—	—
Driver-selectable Switchable Active Sport Exhaust	●Man	●Man ○Auto	●	●	●
Exhaust tips, dual bright	Center mounted	●	●	●	—
	Outboard mounted	—	—	—	●
	Outboard mounted - Lightweight Inconel Titanium - 'SVR' Branded	—	—	—	—

SAFETY & SECURITY

SAFETY

	F-TYPE	F-TYPE PREMIUM	F-TYPE S	F-TYPE R	F-TYPE SVR
Adaptive Restraint Technology System with a weight sensor on passenger seat, safety belt usage sensor and driver seat track location sensor	●	●	●	●	●
Belt-minder system with audio reminder chime and flashing warning light - engages if vehicle is moving more than 10 mph and safety belt is not buckled on occupied driver and/or front passenger seat ⁶	●	●	●	●	●
Driver and front passenger safety belt ⁶ pretensioners	●	●	●	●	●
Smart Airbag System - driver and passenger front airbags ⁶	●	●	●	●	●
Side Airbags - seat-mounted with head protection ⁶	●	●	●	●	●
Tethers for Child seat	●	●	●	●	●
Tire Pressure Monitoring System	●	●	●	●	●
Rollover Protection Bar covers	Carbon Fiber	—	—	—	P9
	Satin Chrome	●	●	●	—
	Gloss Black	—	—	—	●

LOCKING

2-Stage unlocking, programmable	●	●	●	●	●
Central locking with drive-away door locking	●	●	●	●	●
Jaguar Smart Key™ with Keyless Entry: emergency key blade, remote unlocking/locking, access to trunk, activates convenience headlamp-on and panic alarm	—	●	●	●	●
Passenger-side glove box - lockable	●	●	●	●	●
Valet lock-out for trunk and glove box, Touch-screen programmable	●	●	●	●	●

SECURITY

Anti-theft engine immobilizer	●	●	●	●	●
Perimeter security system	●	●	●	●	●
Jaguar Smart Key™ with Keyless push button start	Black button	●	●	●Man	●
	Ignis button	—	—	●Auto	—
Emergency phosphorescent release in trunk	●	●	●	●	●

CONVENIENCE

	F-TYPE	F-TYPE PREMIUM	F-TYPE S	F-TYPE R	F-TYPE SVR
Auxiliary power socket x2 (center console, center dash)	●	●	●	●	●
Cup-holders - dual, center console, concealed under cover	●	●	●	●	●
Trunk release - remote	●	●	●	●	●
Powered Tailgate (Coupe only)	—	P1	P1	●	●
Fuel door - push to open	●	●	●	●	●
HomeLink Garage door/entry gate opener - three channel	—	P1	P1	●	●

CLIMATE CONTROL

Active Center Air Vent	●	●	●	●	●
Single-zone climate control	●	●	●	—	—
Dual-zone climate control	—	P1	P1	●	●
Dual-function rotary climate control dials: temperature and seat heating	—	P1	P1	●	●
Air particle / pollen filtration	●	●	●	●	●
Air quality sensor	—	P1	P1	●	●

CRUISE CONTROL

Controls on steering wheel	●	●	●	●	●
Active Speed Limiter (ASL) with speed limit range of 18 mph to 150 mph	●	●	●	●	●

PARKING ASSISTANCE

Front parking sensors with graphic display on Touch-screen	—	P1	P1	P3	●
Rear parking sensors with graphic display on Touch-screen	—	P1	P1	●	●
Reverse Park Camera with display on Touch-screen	—	P1	P1	P3	●
Reverse Traffic Detection ⁵	—	P1	P1	P3	●

DRIVER ASSISTANCE

Blind Spot Monitor ⁵	—	P1	P1	P3	●
---------------------------------	---	----	----	----	---

2 CHOOSE YOUR MODEL & PACKAGES

 Configure your vehicle at JAGUARUSA.COM

EXTERIOR FEATURES		F-TYPE	F-TYPE PREMIUM	F-TYPE S	F-TYPE R	F-TYPE SVR
BODY EXTERIOR APPEARANCE						
Bumpers, Body colored		●	●	●	●	●
Badging	Front grille and rear trunk 'S'	—	—	●RWD	—	—
	Front grille and rear trunk 'S AWD'	—	—	●AWD	—	—
	Front grille and rear trunk 'R AWD'	—	—	—	●	—
	Front grille and rear trunk 'SVR'	—	—	—	—	●
	Jaguar leaper and wordmarque on rear spoiler	●	●	●	●	●
	Rear trunk 'F-TYPE'	●	●	●	●	●
Deployable Door handles, Body colored	●	●	●	●	●	
Deployable Rear Spoiler (60mph Convertible; 70mph Coupe)	●	●	●	●	—	
Carbon Fiber Deployable Rear Spoiler	—	—	—	—	●	
Front Grille	Bright-finish surround with Satin Black grille and bumper beam	●	●	●	●	—
	Black-finish surround and Satin Black mesh and bumper beam	—	P7/P8	P7/P8	—	—
	Gloss Black-finish surround and Gloss Black mesh and bumper beam	—	—	—	P7	●
	Satin Black	●	●	—	—	—
Hood louvers	Gloss Black	—	P7/P8	●RWD	—	●
	Body colored	—	—	●AWD	●	—
	Carbon Fiber	—	—	—	—	P9
Front splitter	Satin Black	●	●	—	—	—
	Gloss Black	—	P7/P8	●	●	●
Aero splitters	Satin Black	●	●	●	—	●
	Gloss Black	—	P7/P8	P7/P8	—	—
Front splitter and Aero splitters	Body colored	—	—	●AWD	●	—
	Body colored	—	P6/P8	P6/P8	—	—

		F-TYPE	F-TYPE PREMIUM	F-TYPE S	F-TYPE R	F-TYPE SVR
Rear valance	Satin Black	●	●	—	—	—
	Gloss Black	—	P6/P8	●RWD	—	—
Rear venturi	Body colored (AWD) - V6	—	—	●AWD	—	—
	Body colored (AWD) - V8	—	—	—	●	●
	Carbon Fiber	—	—	—	—	P9
Side vent	Chrome surround and Satin Black mesh	●	●	●	●	—
	Gloss Black surround and Satin Black mesh	—	P7/P8	P7/P8	P7	—
	Gloss Black surround and Gloss Black mesh	—	—	—	—	●
	Carbon Fiber	—	—	—	—	P9
Side sill extensions	Body colored	—	P6/P8	P6/P8	—	—
	Body colored, extended (AWD)	—	—	●AWD	●	●
Door mirrors	Body colored	●	●	●	●	●
	Power fold, electric adjustment, heated, tinted glass	—	●	●	—	—
	Power fold, electric adjustment, heated, auto dimming, tinted glass	—	P1	P1	●	●
LIGHTING						
Auto on/off headlamps		●	●	●	●	●
Bi-Xenon High Intensity Discharge (HID) headlamps with dynamic leveling		●	●	●	●	●
LED signature running lamps		●	●	●	●	●
Rear Fog lamps		●	●	●	●	●
Headlamp powerwash		●	●	●	●	●
Auto headlamp 'On' with wipers, engage automatically after wipers active for 20 seconds		●	●	●	●	●
Partial Light Emitting Diode (LED) rear Lamps		●	●	●	●	●
Adaptive Front Lighting (AFL) with Cornering Lamps		—	●	●	●	●
Intelligent High Beam		—	●	●	●	●

● Standard ○ Optional — Not available

P1 Premium + Vision Package P2 Climate Package P3 Vision Package P4 Extended Leather Package P5 Extended Leather Package - Upper Environment P6 Design Package P7 Black Package P8 Design + Black Package P9 Exterior Carbon Fiber Package P10 Interior Black Package P11 Carbon Ceramic Braking System P12 Super Performance Braking Package P13 Suedecloth Interior Package P14 Red Leather Interior Package

Disclaimers apply. Please see page 120 for further details.

INTERIOR FEATURES

	F-TYPE	F-TYPE PREMIUM	F-TYPE S	F-TYPE R	F-TYPE SVR
HEADLINER					
Morzine headliner (w/Jet Rakona lining on convertible top) - Jet Black	●	●	●	●	●
Leather headliner (w/Jet Rakona lining on convertible top) - Jet Black	—	P4/P5	P4/P5	P5	P5
Leather headliner (w/Jet Rakona lining on convertible top) - Red (Convertible only)	—	P4/P5	P4/P5	P5	P5
Leather headliner (w/Jet Rakona lining on convertible top) - Ivory	—	P4/P5	P4/P5	P5	P5
Suedecloth headliner (w/Jet Rakona lining on convertible top) - Jet Black	—	P13	P13	P13	●
TRIM					
Leather and Suedecloth seating surfaces	●	●	●	—	—
Leather seating surfaces	—	○	○	—	—
Premium leather seating surfaces with 'R' logo and Carbon leather stripe	—	—	—	●	—
Lozenge quilted leather seating surfaces with 'SVR' logo	—	—	—	—	●
Contrast stitch premium leather	—	P4	P4	●	●
Suedecloth interior	—	P13	P13	P13	—
Leatherette dash, door trim and center console trim	●	●	●	—	—
Premium leather dash, door trim, center console trim	—	P4	P4	●	●
Metallic Foot Pedals	—	—	●Auto	●	●
Door sill treadplates Illuminated	—	○	○	○	○
VENEER					
Light Hex Aluminum trim	●	●	—	—	—
Dark Hex Aluminum trim	—	—	●	—	—
Dark Linear Aluminum trim	—	—	—	●	—
Dark Brushed Aluminum trim	—	—	—	—	●
Carbon Fiber trim	—	—	—	—	○
Black Hex Aluminum trim	—	P10	P10	—	—

CARPET

	F-TYPE	F-TYPE PREMIUM	F-TYPE S	F-TYPE R	F-TYPE SVR	
Jet Carpet Mats	Premium	●	●	—	—	
	Sport	—	—	●	—	
	Nubuck Edged	—	—	—	—	●
	'R'	—	—	—	●	—

INSTRUMENTATION

	F-TYPE	F-TYPE PREMIUM	F-TYPE S	F-TYPE R	F-TYPE SVR
Analog Speedometer and Tachometer	●	●	●	●	●
5-inch color TFT display in center of instrument cluster	●	●	●	●	●

MIRRORS

	F-TYPE	F-TYPE PREMIUM	F-TYPE S	F-TYPE R	F-TYPE SVR
Rearview mirror, electrochromic (auto dimming)	●	●	●	●	●

LIGHTING

	F-TYPE	F-TYPE PREMIUM	F-TYPE S	F-TYPE R	F-TYPE SVR
Interior ambient lighting, Phosphor Blue	●	●	—	—	—
Configurable interior ambient lighting, choice of five colors	—	—	●	●	●
Reading/map lamps (JaguarSense)	●	●	●	●	●
Trunk lighting	●	●	●	●	●

SEATING

	F-TYPE	F-TYPE PREMIUM	F-TYPE S	F-TYPE R	F-TYPE SVR
Sport-style 6-way seats, manual/power adjustable, driver and passenger	●	—	—	—	—
Sport-style 14-way seats, power adjustable, driver and passenger	—	●	●	—	—
Performance-style 14-way seats, power adjustable, driver and passenger (requires option pack - P4, P13 or P14)	—	○	○	●	●
3-position seat, door mirror and steering column memory	—	●	●	●	●
Door-mounted power seat controls - 4-way (power height & recline)	●	—	—	—	—
Door-mounted power seat controls - 14-way control	—	●	●	●	●
Heated front seats, variable settings	P2	P1/P2	P1/P2	●	●
Seatbelts	Jet Black	●	●	●	●
	Red	—	○	○	○
	Camel Tan	—	○	○	○

2 CHOOSE YOUR MODEL & PACKAGES

 Configure your vehicle at JAGUARUSA.COM

INTERIOR FEATURES CONTINUED		F-TYPE	F-TYPE PREMIUM	F-TYPE S	F-TYPE R	F-TYPE SVR
STEERING WHEEL						
Leather 3-spoke multi-function steering wheel	Round	●	●	○	○	●
	Flat-bottomed	—	P10	●	●	—
Steering wheel-mounted shift paddles	Black	●Auto	●Auto	P10	—	—
	Silver	—	—	—	●	—
	Metallic	—	—	—	—	●
	Ignis	—	—	●	—	—
Steering column - electrically adjustable, tilt-away entry/exit		●	—	—	—	—
Steering column - electrically adjustable, tilt-away entry/exit, memory		—	●	●	●	●
Heated steering wheel		P2	P1/P2	P1/P2	●	●
STOWAGE						
Glove box, locking with pen holder		●	●	●	●	●
Rear bulkhead storage cubby with cargo net (convertible) or bin (coupe)		●	●	●	●	●
Rear bulkhead storage cubby with lockable lid (convertible)		—	P1	P1	●	●
Door pockets, integrated		●	●	●	●	●
Center console storage		●	●	●	●	●
WINDOWS						
Power front windows with anti-trap and one-touch up/down, operates for 5 minutes in the Convenience Mode when the doors remain closed		●	●	●	●	●
Infra Red Reflective Windshield		●	●	●	●	●
Heated glass rear window with timer		●	●	●	●	●
Heated front windshield		—	○	○	○	○
Windshield wipers - rain sensing		●	●	●	●	●
Wind Deflector - Mesh (mounts between Roll Hoops)		—	P1	P1	●	●

● Standard ○ Optional — Not available

P1 Premium + Vision Package P2 Climate Package P3 Vision Package P4 Extended Leather Package P5 Extended Leather Package - Upper Environment P6 Design Package P7 Black Package P8 Design + Black Package P9 Exterior Carbon Fiber Package P10 Interior Black Package P11 Carbon Ceramic Braking System P12 Super Performance Braking Package P13 Suedecloth Interior Package P14 Red Leather Interior Package

Disclaimers apply. Please see page 120 for further details.

INFORMATION, COMMUNICATION AND ENTERTAINMENT

INFORMATION, COMMUNICATION AND ENTERTAINMENT	F-TYPE	F-TYPE PREMIUM	F-TYPE S	F-TYPE R	F-TYPE SVR
MULTIMEDIA					
Analog Speedometer and Tachometer	●	●	●	●	●
5" color TFT display in center of instrument cluster	●	●	●	●	●
8" capacitive Touch-screen display with controls for audio, climate control, Bluetooth® telephone connectivity and navigation ¹	●	●	●	●	●
Meridian 770W audio system - 12 speakers	●	●	●	●	●
HD Radio	●	●	●	●	●
SiriusXM® Satellite Radio with trial subscription ⁴	●	●	●	●	●
CD player, mounted in center console	●	●	●	●	●
iPod®/Audio USB connection in center console	●	●	●	●	●
Aux Audio jack port in center console	●	●	●	●	●
Multi-function steering wheel audio controls	●	●	●	●	●
InControl Apps™ Enables use of optimized 3 rd party smartphone apps installed on a phone through the vehicle's Touch-screen	●	●	●	●	●
STEERING					
Navigation System with Traffic Message Channel (TMC) ²	●	●	●	●	●
Bluetooth® wireless technology with Audio streaming	●	●	●	●	●
TELEMATICS					
InControl Remote™ - Smart phone application for vehicle status (fuel level, security status, last parked, direction to vehicle), vehicle lock/unlock, A/C remote setting through engine start. Feature complimentary for 5 years	●	●	●	●	●
InControl Protect™ - SOS emergency call, Optimized Jaguar Assistance and Stolen vehicle locator. Service complimentary for 5 years	●	●	●	●	●

OPTIONS PACKAGES

	CODE	F-TYPE	F-TYPE PREMIUM	F-TYPE S	F-TYPE R	F-TYPE SVR	DESCRIPTION
Premium + Vision Package ⁵	Z61T	—	○	○	—	—	Dual Zone Automatic Climate Control, Air Quality Sensor, Exterior Door Mirrors w/ auto dimming, Garage Door Opener, Wind Deflector (Convertible only), Interior Storage with lockable cover (Convertible only), Power tailgate (Coupe only), Heated Seats, Heated Steering Wheel, Front Parking Sensors, Rear Parking Sensors, Rear Parking Camera, Blind Spot Monitor, Reverse Traffic Detection
Climate Package	Z88L	○	○	○	●	●	Heated Seats & Heated Steering Wheel (also included in Premium + Vision Package above)
Vision Package ⁵	Z37B	—	—	—	○	●	Front Parking Sensors, Rear Parking Camera, Blind Spot Monitor, Reverse Traffic Detection
Extended Leather Package	Z84P	—	○	○	—	—	Premium soft grain leather seating surfaces, dashboard, door panels, center console, windshield pillars, header rail and sunvisors (requires Performance Seat, except TP01 and TP04)
Extended Leather Package - Upper Environment only	Z23C	—	○	○	○	○	Leather headliner, windshield pillars and sunvisors. Jet, Red or Ivory (Ivory not available with Panoramic roof and therefore requires Carbon Fiber roof on Coupe models; Red not available on Coupe models; Ivory not available on SVR)
Design Package	Z93M	—	○	○RWD	—	—	Body colored front bumper Splitter and Aero Splitters, Body colored side Sill Extensions and rear Venturi, Gloss Black rear Valance
Black Package	Z93L (RWD) Z93Z (AWD)	—	○	○	○	—	Gloss Black Front Grille Surround, Beam and Mesh, Gloss Black Hood Louvers and Mesh, Gloss Black front bumper Splitter and Aero Splitters, Gloss Black side Power Vents and mesh, Gloss Black Roll Hoops (Convertible models only), Gloss Black window surrounds (Coupe models only), Gloss Black rear Valance (adds Interior Black Package Z01P - Black interior trim)
Design + Black Package	Z93N	—	○	○RWD	—	—	Combines Design Package and Black Package content adds Interior Black Package (Z01P)
Exterior Carbon Fiber Package	Z94I	—	—	—	—	○	Carbon Fiber Hood Louvers, Carbon Fiber Mirror Caps, Carbon Roll Hoops (Convertible models only), Carbon Fiber front bumper Splitter, Carbon Fiber Side Power Vents, Carbon Fiber Venturi Blade

2 CHOOSE YOUR MODEL & PACKAGES

 Configure your vehicle at JAGUARUSA.COM

OPTIONS PACKAGES CONTINUED

	CODE	F-TYPE	F-TYPE PREMIUM	F-TYPE S	F-TYPE R	F-TYPE SVR	DESCRIPTION
Interior Black Package	Z01P	—	○	○	—	—	Black Interior Trim, Black Hex Console Trim (requires an Exterior Black Package)
Suede cloth Interior Package	TP22	—	○	○	○	—	Performance seat with Suede cloth facings, door inserts, grab handle inner, instrument binnacle, headliner (Rakona cloth lining on convertibles), A-pillars and sunvisors, Cirrus contrast stitch on seats, doors and fascia (requires Performance Seat)
Red Leather Interior Package	TP23/Z84T	—	○	○	○	○	Red seats, Red passenger-side fascia, Red center console, Red door panels (requires Performance Seat)
Sienna Tan Leather Interior Package	TP34/Z84T	—	—	—	—	○	Sienna Tan seats, passenger-side fascia, center console and door panels
Carbon Ceramic Matrix (CCM) Braking System	Z73N/C51T	—	—	○ Auto	○	—	398mm front / 380mm rear rotors, 6 piston front / 4 piston rear calipers in Yellow, Packaged with 20" Storm alloy wheels
Carbon Ceramic Matrix (CCM) Braking System	Z73R/C55S	—	—	—	—	○	398mm front / 380mm rear rotors, 6 piston front / 4 piston rear calipers in Yellow, Packaged with 20" Maelstrom forged alloy wheels
Super Performance Braking Package	Z38H/C08C	—	—	○	●	●	Super Performance Braking System, Red Brake Calipers, Torque Vectoring by Braking

● Standard ○ Optional — Not available

P1 Premium + Vision Package P2 Climate Package P3 Vision Package P4 Extended Leather Package P5 Extended Leather Package - Upper Environment P6 Design Package P7 Black Package P8 Design + Black Package P9 Exterior Carbon Fiber Package P10 Interior Black Package P11 Carbon Ceramic Braking System P12 Super Performance Braking Package P13 Suede cloth Interior Package P14 Red Leather Interior Package

Disclaimers apply. Please see page 120 for further details.

STAND ALONE OPTIONS

		F-TYPE	F-TYPE PREMIUM	F-TYPE S	F-TYPE R	F-TYPE SVR	
	CODE						DESCRIPTION
Carbon Fiber Roof	F45B	—	○	○	○	○	Available on Coupe only
Heated Front Windshield	D96A	—	○	○	○	○	—
Illuminated Door Sill Treadplates	F28F	—	○	○	○	○	—
Switchable Active Exhaust	S66A	● Man	○ Auto ● Man	●	●	●	—
Performance Seat	B55C	—	○	○	●	●	Requires Extended Leather Package or Suedecloth Interior Package
Round Steering Wheel	F95Y/F96L	●	●	○	○	●	—
Leather Seating Surfaces	B40W	—	○	○	—	—	—
Black Brake Calipers	C10Y	—	—	●	○	—	—
Seatbelt Color	RCHX/RSFA	—	○	○	○	○	A choice of Red or Camel seatbelt upgrade
Carbon Fiber Center Console	B80A	—	—	—	—	○	—
Convertible Top Color	LCHH/LLKB/LSAL	—	○	○	○	○	Available on convertible only. A choice of Red, Grey or Beige

3 CHOOSE YOUR COLOR

 Configure your vehicle at [JAGUARUSA.COM](https://www.jaguarusa.com)

SOLID

Polaris White

Caldera Red

Ebony Black

METALLIC

Glacier White

Rhodium Silver

Ammonite Grey

Ultimate Black

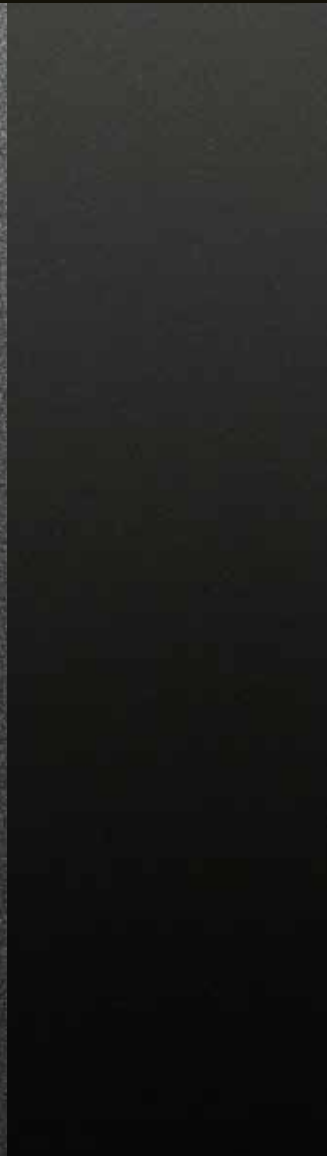
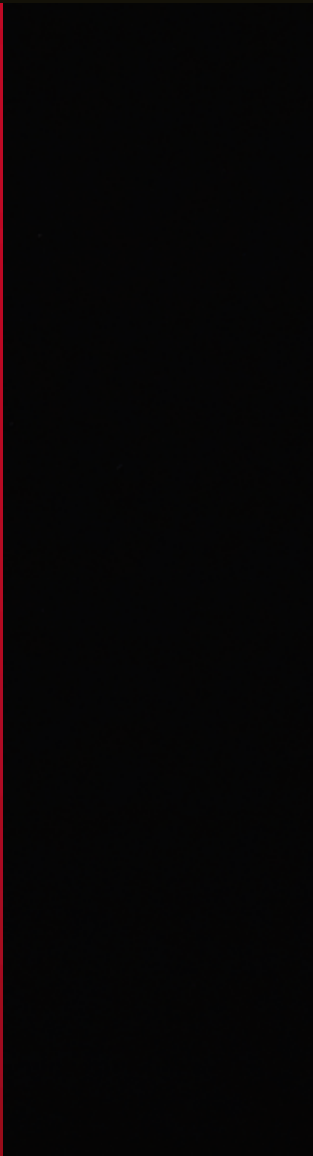
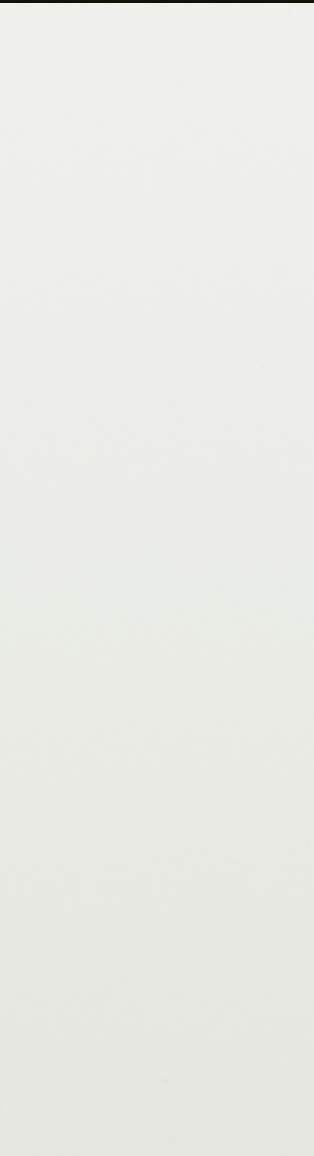

Dark Sapphire



Firesand



Italian Racing Red



British Racing Green



Ultra Blue



PREMIUM

Storm Grey



Black Berry



4 CHOOSE YOUR WHEELS

 Configure your vehicle at JAGUARUSA.COM



18" VELA



19" PROPELLER



19" CENTRIFUGE



19" CENTRIFUGE



19" ORBIT



19" ORBIT

ALLOY WHEEL FINISH	Silver	Silver	Silver	Gloss Black	Silver	Gloss Black/ Diamond Turned
FRONT ALLOY WHEELS	8.5J x 18"	8.5J x 19"	8.5J x 19"	8.5J x 19"	8.5J x 19"	8.5J x 19"
FRONT TIRES	245/45 R18	245/40 R19	245/40 R19	245/40 R19	245/40 R19	245/40 R19
REAR ALLOY WHEELS	9.5J x 18"	9.5J x 19"	9.5J x 19"	9.5J x 19"	9.5J x 19"	9.5J x 19"
REAR TIRES	275/40 R18	275/35 R19	275/35 R19	275/35 R19	275/35 R19	275/35 R19
F-TYPE	●	—	—	—	—	—
F-TYPE PREMIUM	●	—	—	—	○	○
F-TYPE S	—	●	○	○	○	○
F-TYPE S AWD	—	—	—	—	○	○
F-TYPE R	—	—	—	—	—	—
F-TYPE SVR	—	—	—	—	—	—



19" VOLUTION



19" VOLUTION



20" CYCLONE



20" CYCLONE



20" GYRODYNE



20" GYRODYNE

ALLOY WHEEL FINISH	Silver	Technical Grey/ Diamond Turned	Silver	Gloss Black	Silver	Dark Grey/ Diamond Turned
FRONT ALLOY WHEELS	8.5J x 19"	8.5J x 19"	9.0J x 20"	9.0J x 20"	9.0J x 20"	9.0J x 20"
FRONT TIRES	245/40 R19	245/40 R19	255/35 R20	255/35 R20	255/35 R20	255/35 R20
REAR ALLOY WHEELS	9.5J x 19"	9.5J x 19"	10.5J x 20"	10.5J x 20"	10.5J x 20"	10.5J x 20"
REAR TIRES	275/35 R19	275/35 R19	295/30 R20	295/30 R20	295/30 R20	295/30 R20
F-TYPE	—	—	—	—	—	—
F-TYPE PREMIUM	—	—	○	○	—	—
F-TYPE S	—	—	—	—	—	—
F-TYPE S AWD	●	○	—	—	—	—
F-TYPE R	—	—	—	—	●	○
F-TYPE SVR	—	—	—	—	—	—



20" ROTOR

20" TORNADO

20" TORNADO

20" BLADE

ALLOY WHEEL FINISH	Forged Alloy. Gloss Black/Carbon Fiber	Silver	Gloss Black	Forged Alloy. Technical Grey/Carbon Fiber
FRONT ALLOY WHEELS	9.0J x 20"	9.0J x 20"	9.0J x 20"	9.0J x 20"
FRONT TIRES	255/35 R20	255/35 R20	255/35 R20	255/35 R20
REAR ALLOY WHEELS	10.5J x 20"	10.5J x 20"	10.5J x 20"	10.5J x 20"
REAR TIRES	295/30 R20	295/30 R20	295/30 R20	295/30 R20

F-TYPE	—	—	—	—
F-TYPE PREMIUM	—	—	—	—
F-TYPE S	—	○	○	○
F-TYPE S AWD	—	○	○	○
F-TYPE R	○	—	—	○
F-TYPE SVR	—	—	—	—



20" STORM

20" CORIOLIS

20" CORIOLIS

20" MAELSTROM

ALLOY WHEEL FINISH	Forged Alloy. Satin Black/Polished	Forged Alloy. Technical Grey	Forged Alloy. Gloss Black	Forged Alloy. Satin Black/Diamond Turned
FRONT ALLOY WHEELS	9.0J x 20"	9.0J x 20"	9.0J x 20"	9.0J x 20"
FRONT TIRES	255/35 R20	265/35 R20	265/35 R20	265/35 R20
REAR ALLOY WHEELS	10.5J x 20"	11J x 20"	11J x 20"	11J x 20"
REAR TIRES	295/30 R20	305/30 R20	305/30 R20	305/30 R20

F-TYPE	—	—	—	—
F-TYPE PREMIUM	—	—	—	—
F-TYPE S	■	—	—	—
F-TYPE S AWD	■	—	—	—
F-TYPE R	■	—	—	—
F-TYPE SVR	—	●	○	■

● Standard ○ Option — Not available ■ Part of pack
Please consult your local Jaguar Retailer for further details.

5 CHOOSE YOUR INTERIOR

 Configure your vehicle at JAGUARUSA.COM

F-TYPE						
	SEAT WITH STITCH	UPPER FASCIA WITH STITCH	HEADLINING	CARPETS	SEATBELTS	INTERIOR TRIM AND OPTION CODES
Standard						
Sport seats with Leather and Suedecloth facings	Jet with Jet	Jet with Jet	Jet	Jet	Jet or Red	TP01
F-TYPE PREMIUM, F-TYPE S AND F-TYPE S AWD						
	SEAT WITH STITCH	UPPER FASCIA WITH STITCH	HEADLINING	CARPETS	SEATBELTS	INTERIOR TRIM AND OPTION CODES
Standard						
Sport seats with Leather and Suedecloth facings	Jet with Jet	Jet with Jet	Jet	Jet	Jet or Red	TP01
	Cirrus with Cirrus	Jet with Jet	Jet	Jet	Jet	TP04
Sport seats with Leather facings	Jet with Jet	Jet with Jet	Jet	Jet	Jet or Red	TP01+B40W
	Cirrus with Cirrus	Jet with Jet	Jet	Jet	Jet	TP04+B40W
Sport seats in Premium Leather and Premium Leather interior*	Jet with Jet	Jet with Jet	Jet	Jet	Jet or Red	TP01+Z84P
	Cirrus with Cirrus	Jet with Jet	Jet	Jet	Jet	TP04+Z84P
Performance seats in Premium Leather and Premium Leather interior*	Jet with Jet	Jet with Jet	Jet or Ivory**	Jet	Jet or Red	TP01+B55C+Z84P
	Jet with Red	Jet with Jet	Jet or Red†	Jet	Jet or Red	TP05+B55+Z84P
	Jet with Camel	Jet with Jet	Jet	Jet	Jet or Camel	TP06+B55+Z84P
	Jet with Firesand	Jet with Jet	Jet	Jet	Jet	TP07+B55+Z84P
	Brogue with Ivory	Jet with Jet	Jet or Ivory**	Jet	Jet	TP11+B55+Z84P
	Red with Jet	Jet with Jet	Jet or Red†	Jet	Jet or Red	TP12+B55+Z84P
	Camel with Jet	Jet with Jet	Jet	Jet	Jet or Camel	TP13+B55+Z84P
	Cirrus with Jet	Jet with Jet	Jet	Jet	Jet	TP27+B55+Z84P
	Ivory with Jet	Jet with Jet	Jet or Ivory**	Jet	Jet	TP28+B55+Z84P
Suedecloth Interior Package - Performance seats in Premium Leather and Suedecloth and Premium Leather interior*	Jet with Cirrus	Jet with Cirrus	Jet Suedecloth	Jet	Jet	TP22+B55C
Red Leather Interior Package - Performance seats in Red Premium Leather and Red Premium Leather interior with Jet twin needle contrast stitching*	Red with Jet	Red with Jet	Jet or Red†	Jet	Jet or Red	TP23+B55C+Z84T

F-TYPE R						
	SEAT WITH STITCH	UPPER FASCIA WITH STITCH	HEADLINING	CARPETS	SEATBELTS	INTERIOR TRIM AND OPTION CODES
Standard						
Performance seats in Premium Leather with 'R' embossed headrests and Carbon Fiber effect center strip and Premium Leather interior with twin needle stitching	Jet with Jet	Jet with Jet	Jet or Ivory**	Jet	Jet or Red	TP01
	Jet with Ivory	Jet with Ivory	Jet or Ivory**	Jet	Jet	TP17
	Jet with Red	Jet with Red	Jet or Red†	Jet	Jet or Red	TP24
	Jet with Firesand	Jet with Firesand	Jet	Jet	Jet	TP18
Performance seats in Premium Leather with 'R' embossed headrests and Premium Leather interior with twin needle stitching	Camel and Jet duotone with Camel	Jet with Camel	Jet	Jet	Jet or Camel	TP21
	Ivory and Jet duotone with Ivory	Jet with Ivory	Jet or Ivory**	Jet	Jet	TP20
	Red and Jet duotone with Red	Jet with Red	Jet or Red†	Jet	Jet or Red	TP19
Optional						
Suedecloth Interior Package - Performance seats in Premium Leather and Suedecloth and Premium Leather interior	Jet with Cirrus	Jet with Cirrus	Jet Suedecloth	Jet	Jet	TP22
Red Leather Interior Package - Performance seats in Red Premium Leather and Red Premium Leather interior with Jet twin needle contrast stitching**	Red with Jet	Red with Jet	Jet or Red†	Jet	Jet or Red	TP23
F-TYPE SVR						
	SEAT WITH STITCH	UPPER FASCIA WITH STITCH	HEADLINING	CARPETS	SEATBELTS	INTERIOR TRIM AND OPTION CODES
Standard						
Quilted Performance seats in Premium Leather with 'SVR' embossed headrests with twin needle stitching and Suedecloth driver's Instrument Panel area	Jet with Cirrus	Jet with Cirrus	Jet	Jet	Jet	TP31
	Jet with Red	Jet with Red	Jet or Red†	Jet	Jet or Red	TP30
	Jet with Reims Blue	Jet with Reims Blue	Jet	Jet	Jet	TP32
Optional						
Quilted Performance seats in Premium Leather with 'SVR' embossed headrests with twin needle stitching and extended Leather upper fascia‡	Red with Jet	Red with Jet	Jet or Red†	Jet	Red	TP23
	Sienna Tan with Cirrus	Sienna Tan with Cirrus	Jet	Jet	Jet	TP34

*Premium Leather interior adds Premium Leather to the upper fascia, center console and door casings.

**Ivory Leather optional. Not available in conjunction with panoramic roof.

†Red Leather optional. Available on convertible only.

‡Includes Red Premium Leather passenger side upper fascia, upper door casings, center console and Jet carpet mats with Red Leather edging and Jet contrast stitching.

‡Includes colored Premium Leather passenger side upper fascia, upper door facings, center console and Jet carpet mats with colored Leather edging and contrast stitching.

Please consult your local Jaguar Retailer for further details.

5 CHOOSE YOUR INTERIOR

⚙️ Configure your vehicle at JAGUARUSA.COM





Interior shown: Jet Leather and Suedecloth Sport seats with Light Hex Aluminum finisher with Jet Morzine headlining, Jet upper fascia and Jet carpets.

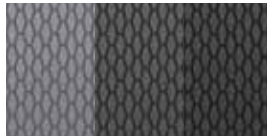
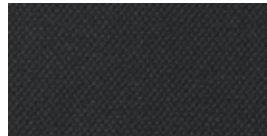

F-TYPE, F-TYPE PREMIUM, F-TYPE S AND F-TYPE S AWD

INTERIOR COLOR COMBINATIONS

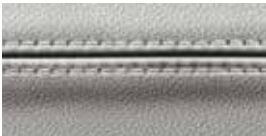
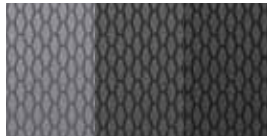
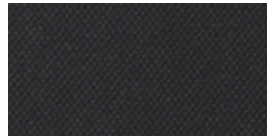
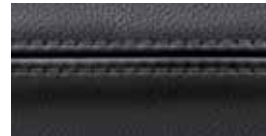
STANDARD LEATHER AND SUEDECLOTH FACINGS, OPTIONAL LEATHER FACINGS AND OPTIONAL PREMIUM LEATHER INTERIOR

①	②	③	④	⑤
SEAT WITH STITCH	FINISHER	HEADLINING*	UPPER FASCIA WITH STITCH	CARPET
				
Jet with Jet**	Light**, Dark or Black Hex+	Jet	Jet with Jet	Jet
				
Cirrus with Cirrus	Light, Dark or Black Hex+	Jet	Jet with Jet	Jet

OPTIONAL PERFORMANCE SEATS IN PREMIUM LEATHER AND PREMIUM LEATHER INTERIOR

SEAT WITH STITCH	FINISHER	HEADLINING*	UPPER FASCIA WITH STITCH	CARPET
				
Jet with Jet	Light, Dark or Black Hex+	Jet or Ivory††	Jet with Jet	Jet
				
Jet with Red	Light, Dark or Black Hex+	Jet or Red‡	Jet with Jet	Jet

*Jet Morzine standard. Jet Suedecloth optional.

**Standard on entry F-TYPE derivative. Optional trims and finishers are not available on this derivative.

†Black Hex Aluminum console finisher only available with Interior Black Package.











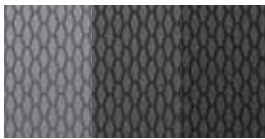



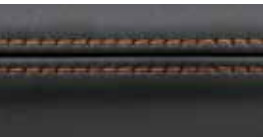
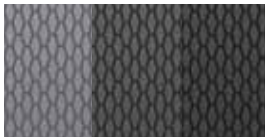



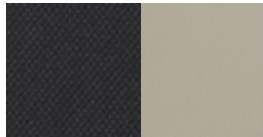

††Ivory Leather optional. Not available in conjunction with panoramic roof.

‡Red Leather optional. Available on convertible only.

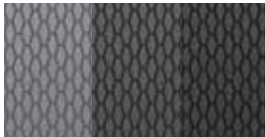
F-TYPE PREMIUM, F-TYPE S AND F-TYPE S AWD

INTERIOR COLOR COMBINATIONS

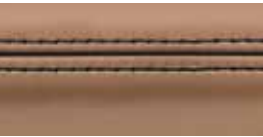
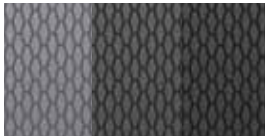
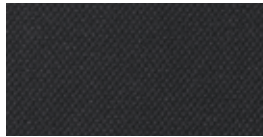
OPTIONAL PERFORMANCE SEATS IN PREMIUM LEATHER AND PREMIUM LEATHER INTERIOR [CONTINUED]

1	2	3	4	5
SEAT WITH STITCH	FINISHER	HEADLINING*	UPPER FASCIA WITH STITCH	CARPET
 Jet with Camel	 Light, Dark or Black Hex**	 Jet	 Jet with Jet	 Jet
 Jet with Firesand	 Light, Dark or Black Hex**	 Jet	 Jet with Jet	 Jet
 Brogue with Ivory	 Light, Dark or Black Hex**	 Jet or Ivory+	 Jet with Jet	 Jet
 Red with Jet	 Light, Dark or Black Hex**	 Jet or Red**	 Jet with Jet	 Jet
 Camel with Jet	 Light, Dark or Black Hex**	 Jet	 Jet with Jet	 Jet







*Jet Morzine standard. Jet Suede cloth optional.

**Black Hex Aluminum console finisher only available with Interior Black Package.

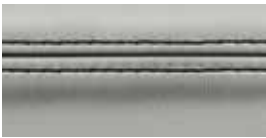
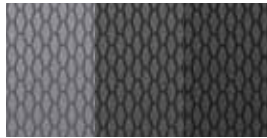
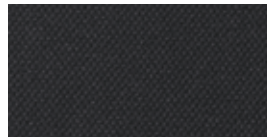
†Ivory Leather optional. Not available in conjunction with panoramic roof.

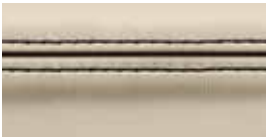
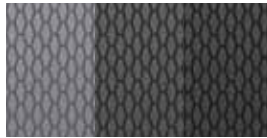
**Red Leather optional. Available on convertible only.

OPTIONAL PERFORMANCE SEATS IN PREMIUM LEATHER AND PREMIUM LEATHER INTERIOR [CONTINUED]

①	②	③	④	⑤
SEAT WITH STITCH	FINISHER	HEADLINING*	UPPER FASCIA WITH STITCH	CARPET
				
Cirrus with Jet	Light, Dark or Black Hex**	Jet	Jet with Jet	Jet
				
Ivory with Jet	Light, Dark or Black Hex**	Jet or Ivory†	Jet with Jet	Jet

OPTIONAL SUEDECLOTH INTERIOR PACKAGE - PERFORMANCE SEATS IN PREMIUM LEATHER AND SUEDECLOTH AND PREMIUM LEATHER INTERIOR

SEAT WITH STITCH	FINISHER	HEADLINING*	UPPER FASCIA WITH STITCH	CARPET
				
Jet with Cirrus	Light, Dark or Black Hex**	Jet	Jet with Cirrus	Jet

OPTIONAL RED LEATHER INTERIOR PACKAGE - PERFORMANCE SEATS IN RED PREMIUM LEATHER AND RED PREMIUM LEATHER INTERIOR WITH JET TWIN NEEDLE CONTRAST STITCHING

SEAT WITH STITCH	FINISHER	HEADLINING*	UPPER FASCIA WITH STITCH	CARPET
				
Red with Jet	Light, Dark or Black Hex**	Jet or Red††	Red with Jet	Jet

5 CHOOSE YOUR INTERIOR

Configure your vehicle at [JAGUARUSA.COM](https://www.jaguarusa.com)













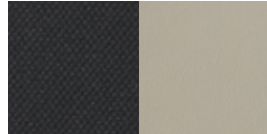

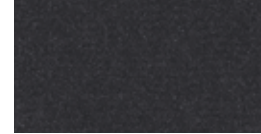

Interior shown: Red Premium Leather Performance seats with Dark Linear Aluminum finisher, Jet headlining, Red upper fascia and Jet carpets.

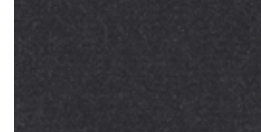

F-TYPE R

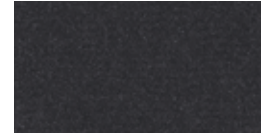
INTERIOR COLOR COMBINATIONS

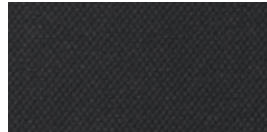
STANDARD R-PERFORMANCE SEATS WITH PREMIUM LEATHER AND PREMIUM LEATHER INTERIOR WITH TWIN NEEDLE STITCHING

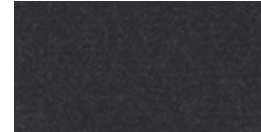
1	2	3	4	5
SEAT WITH STITCH	FINISHER	HEADLINING*	UPPER FASCIA WITH STITCH	CARPET
 Jet with Jet	 Dark Linear	 Jet or Ivory**	 Jet with Jet	 Jet
 Jet with Ivory	 Dark Linear	 Jet or Ivory**	 Jet with Ivory	 Jet
 Jet with Red	 Dark Linear	 Jet or Red*	 Jet with Red	 Jet
 Jet with Firesand	 Dark Linear	 Jet	 Jet with Firesand	 Jet

*Jet Morzine standard. Jet Suedecloth optional.











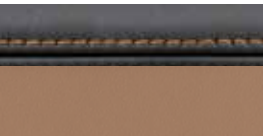

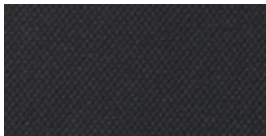
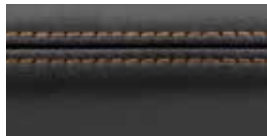
**Ivory Leather optional. Not available in conjunction with panoramic roof.

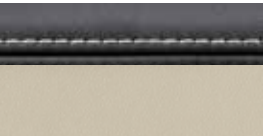
*Red Leather optional. Available on convertible only.

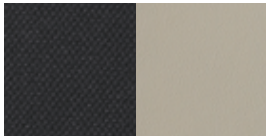
F-TYPE R

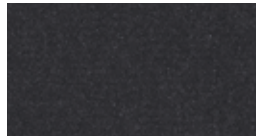
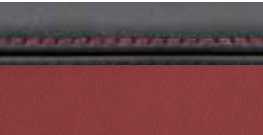
INTERIOR COLOR COMBINATIONS

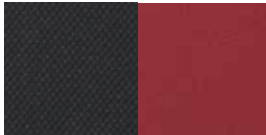
STANDARD R-PERFORMANCE SEATS WITH PREMIUM LEATHER AND PREMIUM LEATHER INTERIOR WITH TWIN NEEDLE STITCHING [CONTINUED]

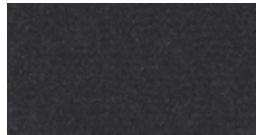
①	②	③	④	⑤
DUOTONE SEAT WITH STITCH	FINISHER	HEADLINING*	UPPER FASCIA WITH STITCH	CARPET
				
Jet with Camel	Dark Linear	Jet	Jet with Camel	Jet
				
Jet with Ivory	Dark Linear	Jet or Ivory**	Jet with Ivory	Jet
				
Jet with Red	Dark Linear	Jet or Red†	Jet with Red	Jet

*Jet Morzine standard. Jet Suede cloth optional.

**Ivory Leather optional. Not available in conjunction with panoramic roof.

†Red Leather optional. Available on convertible only.

OPTIONAL SUEDECLOTH INTERIOR PACKAGE - R-PERFORMANCE SEATS IN PREMIUM LEATHER AND SUEDECLOTH AND PREMIUM LEATHER INTERIOR



OPTIONAL RED LEATHER INTERIOR PACKAGE - R-PERFORMANCE SEATS IN RED PREMIUM LEATHER AND RED PREMIUM LEATHER INTERIOR WITH JET TWIN NEEDLE CONTRAST STITCHING



5 CHOOSE YOUR INTERIOR

Configure your vehicle at [JAGUARUSA.COM](https://www.jaguarusa.com)











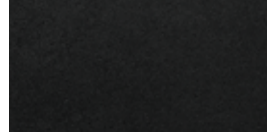

Interior shown: Sienna Tan Quilted Premium Leather Performance seats with Cirrus stitch and Cirrus micro-piping, Dark Brushed Aluminum finisher with Jet Suedecloth headlining, Sienna Tan upper fascia and Jet carpets.

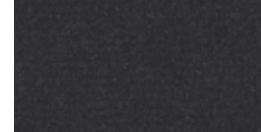

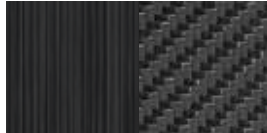

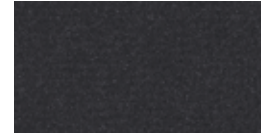

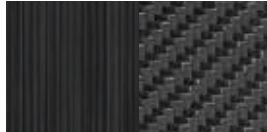
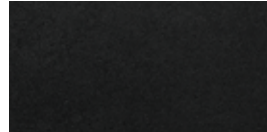

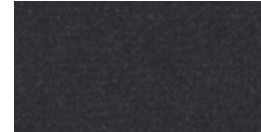
F-TYPE SVR

INTERIOR COLOR COMBINATIONS

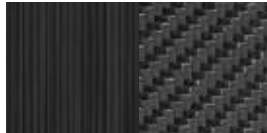
STANDARD SVR QUILTED PREMIUM LEATHER PERFORMANCE SEATS WITH PREMIUM LEATHER AND SUEDECLOTH INTERIOR WITH TWIN NEEDLE STITCHING

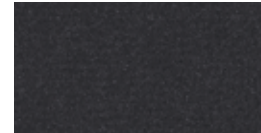
1	2	3	4	5
SEAT WITH STITCH	FINISHER	HEADLINING*	UPPER FASCIA WITH STITCH	CARPET
				
Jet with Cirrus	Dark Brushed Aluminum or Carbon Fiber†	Jet	Jet with Cirrus	Jet
				
Jet with Red	Dark Brushed Aluminum or Carbon Fiber†	Jet or Red**	Jet with Red	Jet
				
Jet with Reims Blue	Dark Brushed Aluminum or Carbon Fiber†	Jet	Jet with Reims Blue	Jet

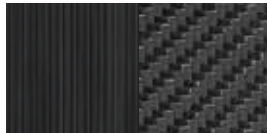
OPTIONAL SVR QUILTED PREMIUM LEATHER PERFORMANCE SEATS WITH PREMIUM LEATHER INTERIOR WITH TWIN NEEDLE STITCHING

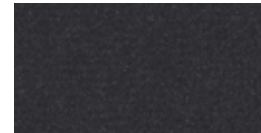
SEAT WITH STITCH	FINISHER	HEADLINING*	UPPER FASCIA WITH STITCH	CARPET
				
Red with Jet	Dark Brushed Aluminum or Carbon Fiber†	Jet or Red**	Red with Jet	Jet
				
Sienna Tan with Cirrus	Dark Brushed Aluminum or Carbon Fiber†	Jet	Sienna Tan with Cirrus	Jet

*Jet Suedecloth standard. Jet Leather optional.

**Red Leather optional. Available on convertible only.

†Optional feature.

5 CHOOSE YOUR INTERIOR

 Configure your vehicle at [JAGUARUSA.COM](https://www.jaguarusa.com)

Light Hex Aluminum Center Console

Dark Hex Aluminum Center Console

Black Hex Aluminum Center Console

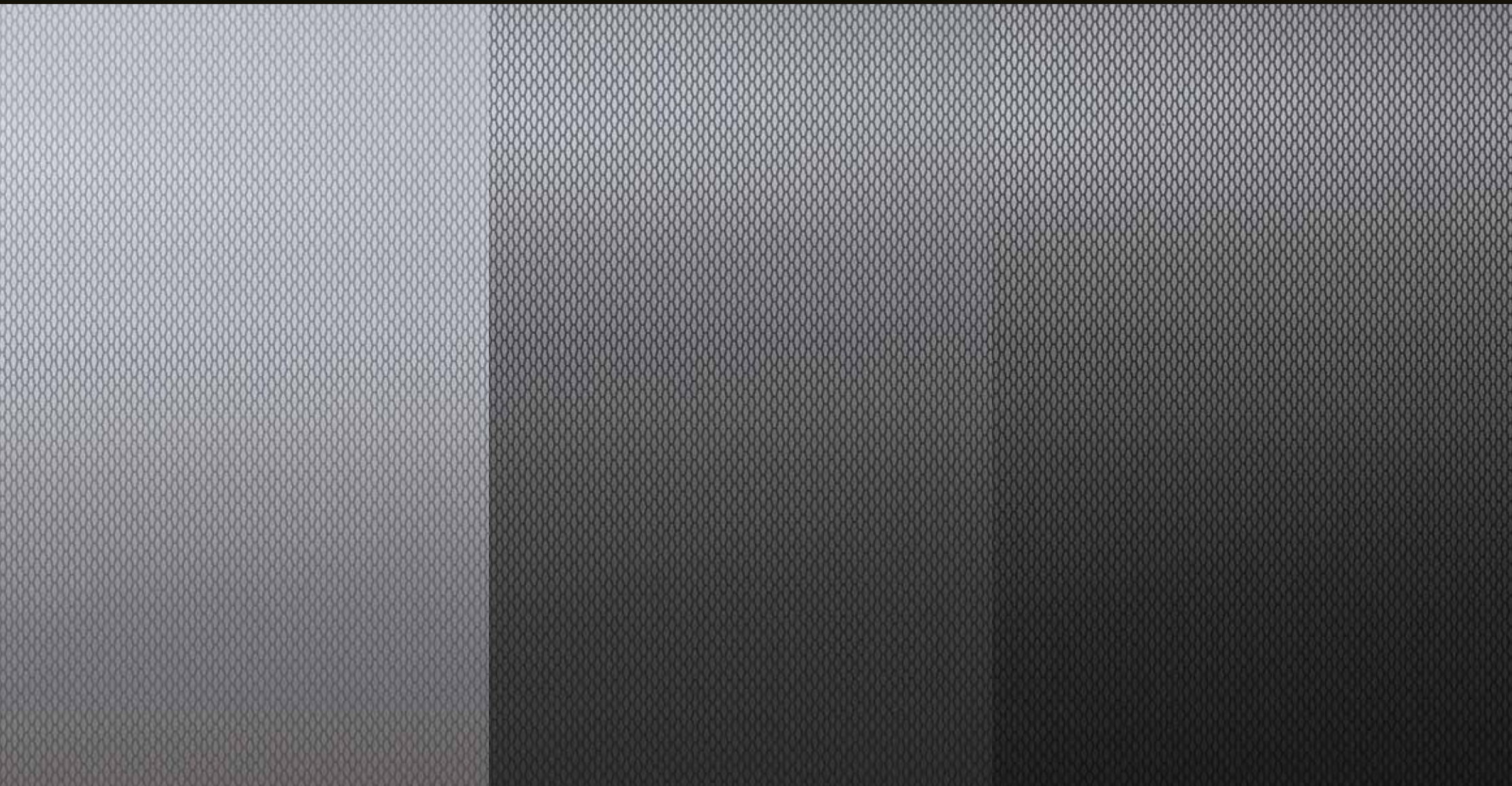

Dark Linear Aluminum with R Graphic Center Console



Dark Brushed Aluminum with SVR Graphic Center Console



Carbon Fiber with SVR Graphic Center Console

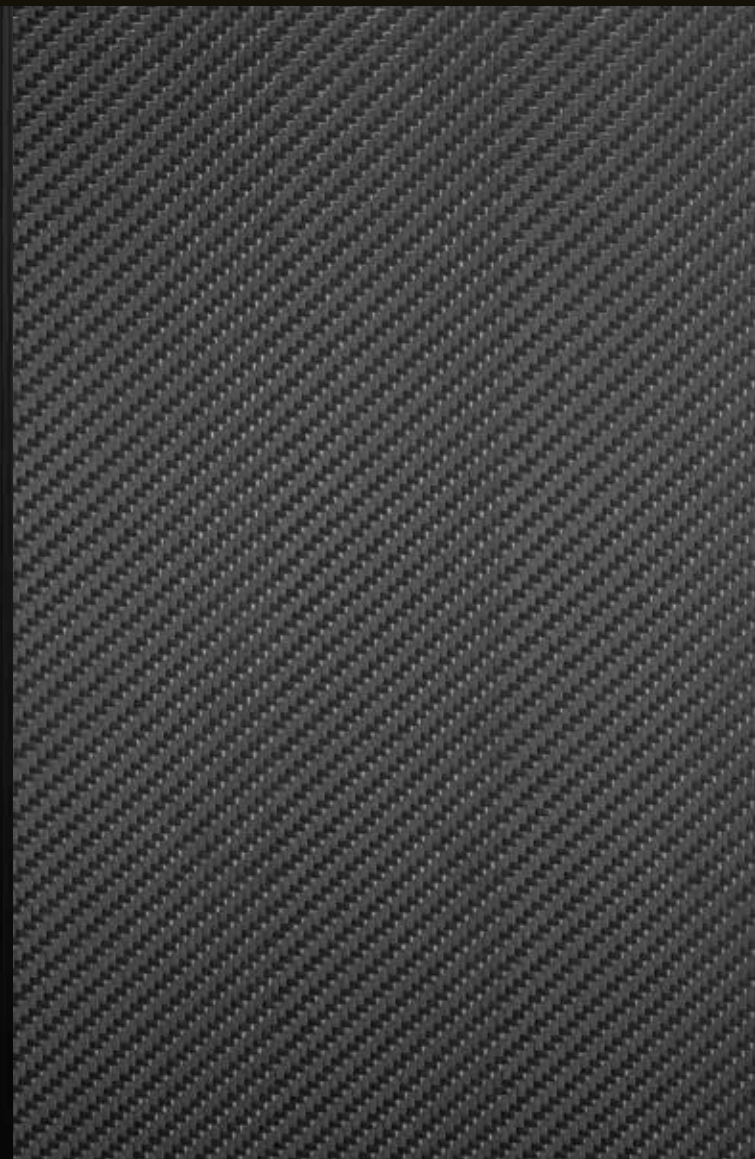

6 CHOOSE YOUR JAGUAR ACCESSORIES

To find out more about the full range of Retailer fit Jaguar Accessories, please refer to your Retailer or go to accessories on JAGUARUSA.COM



VEHICLE SHOWN: F-TYPE S IN CALDERA RED WITH CARBON FIBER PACKAGE AND 20 INCH ROTOR GLOSS BLACK/CARBON FIBER ALLOY WHEELS



Personalized Illuminated Sill Treadplates
T2R6091

Elegantly styled stainless steel sill treadplate finishers for driver or passenger doors. Illuminates when either the driver or passenger doors are opened. Highlighted by soft phosphor blue lighting. Allows customer to specify a monochrome 'motif' in a choice of approved typefaces/scripts.



Chrome Gearshift Paddles
T2R6547MMU

Replacement steering wheel gearshift paddles offered in a premium Chrome material providing a high quality finish to a key contact point in the vehicle.



Carbon Fiber Console Finisher
T2R5267

Exclusive premium finish for the center console offered in a Satin finish to minimize glare and reflections. Comprises Carbon Fiber center console, center dial and center fascia replacement trim.



Sports Pedal Covers (Automatic)
C2P23554

Made from stainless steel and rubber, the pedal kit fits securely over existing pedals for a contemporary, sporting appearance.



Premium Carpet Mats
T2R16570PVJ - Left Hand Drive

Luxurious, tailored 2,050g/m2 pile front carpet mats with embossed Jaguar logo and nubuck edge binding. The premium mats provide a well appointed finishing touch to the interior.



Premium Luggage Compartment Carpet Mat
T2R11270PVJ

Luxurious soft luggage mat in Jet Black with the Jaguar logo. Deep premium 2,050g/m2 pile with nubuck edging.

6 CHOOSE YOUR JAGUAR ACCESSORIES

 Configure your vehicle at JAGUARUSA.COM



Chrome Side Power Vents
T2R2262 - Left Side
T2R2263 - Right Side

Add distinctive sporting style to your vehicle with Chrome finish side power vents with Gloss Black mesh infill panel. Left and right side options available.



Carbon Fiber Side Power Vents
T2R5394 - Left Side
T2R5393 - Right Side

High grade Carbon Fiber side power vents provide a performance-inspired styling upgrade. Left and right side options available.



Carbon Fiber Hood Louvers*
T2R5275PEC - Left Side RWD T2R5274PEC - Right Side RWD
T2R16704 - Left Side AWD T2R16703 - Right Side AWD

High grade Carbon Fiber hood louver featuring a 2x2 twill weave and a High Gloss lacquered finish. Provides a performance-inspired styling enhancement coupled with weight benefits associated with Carbon Fiber. Left and right side options available.



Chrome Mirror Covers
T2R5399 - Left Side
T2R5400 - Right Side

Chrome mirror covers accentuate the stylish design of the exterior mirrors. Left and right side options available.



Carbon Fiber Mirror Covers
T2R5390 - Left Side
T2R5389 - Right Side

High grade Carbon Fiber mirror covers provide a performance-inspired styling upgrade. Left and right side options available.



Carbon Fiber Front Splitter Blade
T2R12001

Premium exterior styling upgrade to highlight the dynamic capabilities of the F-TYPE. Kit includes lower center section of the bumper along with the two outer splitters in a premium high grade Carbon Fiber with a 2x2 twill weave and a High Gloss lacquered finish. Provides a performance-inspired styling enhancement coupled with weight benefits associated with Carbon Fiber.

*Not applicable for AWD models.

**Available for F-TYPE Convertible only.



Carbon Fiber Roll Hoops**
T2R5396 - Left Side
T2R5395 - Right Side

High grade Carbon Fiber roll hoops featuring a 2x2 twill weave and a High Gloss lacquered finish. Provides a performance-inspired styling enhancement coupled with weight benefits associated with Carbon Fiber. Left and right side options available.



UV Sunshade - Front Windshield
T2R10765

Tailor-made for the F-TYPE windshield and features F-TYPE branding. Reflects the sun's rays and helps to keep the interior of the vehicle cool.



Carbon Fiber Engine Cover
T2R8019

Carbon Fiber engine cover provides weight benefits and premium finish to the engine compartment. Features Jaguar branding.



Chrome Roll Hoops**
T2R5402 - Left Side
T2R5401 - Right Side

Bright finish accents highlight the F-TYPE exterior styling cues. Left and right side options available.



Wind Deflector**
T2R6106

Simple to fit and remove, the wind deflector reduces air draught and turbulence in the passenger compartment, even at high speeds. Supplied with a Jaguar branded stowage bag. Optional roll hoops shown.



All Weather Car Cover
T2R4364

All-weather tailored cover for the F-TYPE with the Jaguar logo. Protect your F-TYPE from the elements, including showers, frost and dust. Quick and easy to fit.

TECHNICAL SPECIFICATIONS

 Configure your vehicle at JAGUARUSA.COM

ENGINES		F-TYPE, F-TYPE PREMIUM JAGUAR 3.0 LITER V6 340 SUPERCHARGED PETROL				F-TYPE S JAGUAR 3.0 LITER V6 380 SUPERCHARGED PETROL			
Cylinders/Valves per Cylinder		6/4				6/4			
Bore/Stroke	mm	84.5/89				84.5/89			
Capacity	cc	2,995				2,995			
Maximum power	HP	340				380			
@rev/min		6,500				6,500			
Maximum torque	lb.ft.	332				339			
@rev/min		3,500 - 5,000				3,500 - 5,000			
Compression	ratio:1	10.5				10.5			
PERFORMANCE*		COUPE		CONVERTIBLE		COUPE		CONVERTIBLE	
		MANUAL	AUTOMATIC	MANUAL	AUTOMATIC	MANUAL	AUTOMATIC	MANUAL	AUTOMATIC
0-60 mph	seconds	5.5	5.1	5.5	5.1	5.3	4.8	5.3	4.8
Top speed	mph	161	161	161	161	171	171	171	171
FUEL CONSUMPTION**		COUPE		CONVERTIBLE		COUPE		CONVERTIBLE	
		MANUAL	AUTOMATIC	MANUAL	AUTOMATIC	MANUAL	AUTOMATIC	MANUAL	AUTOMATIC
City	mpg	TBD	TBD	TBD	TBD	TBD	TBD	TBD	TBD
Highway	mpg	TBD	TBD	TBD	TBD	TBD	TBD	TBD	TBD
Combined	mpg	TBD	TBD	TBD	TBD	TBD	TBD	TBD	TBD
Tank capacity (usable)	US gallons	18.5	18.5	18.5	18.5	18.5	18.5	18.5	18.5
DIMENSIONS		COUPE		CONVERTIBLE		COUPE		CONVERTIBLE	
Overall length	in	176.0		176.0		176.0		176.0	
Overall width (inc. mirrors)	in	80.4		80.4		80.4		80.4	
Overall width (exc. mirrors)	in	74.2		74.2		74.2		74.2	
Overall height	in	51.6		51.5		51.6		51.5	
Wheelbase	in	103.2		103.2		103.2		103.2	
Front track	in	62.9		62.9		62.9		62.9	
Rear track	in	64.9		64.9		64.9		64.9	
Ground clearance	in	4.0		4.0		4.0		4.0	
Turning circle diameter (curb to curb)	ft.	35.0		35.0		35.0		35.0	
Convertible trunk volume	cu.ft	—		7.3		—		7.3	
Coupe trunk volume with loadspace cover	cu.ft	10.9		—		10.9		—	
Coupe trunk volume without loadspace cover	cu.ft	14.4		—		14.4		—	
WEIGHT†		COUPE		CONVERTIBLE		COUPE		CONVERTIBLE	
		MANUAL	AUTOMATIC	MANUAL	AUTOMATIC	MANUAL	AUTOMATIC	MANUAL	AUTOMATIC
Weight from	lbs	3,455	3,477	3,499	3,521	3,492	3,514	3,536	3,558
Gross vehicle weight	lbs	4,519	4,519	4,519	4,519	4,519	4,519	4,519	4,519

*Always follow local speed limits.

**EPA estimates not available at time of publication. See your local Jaguar Retailer for updated EPA estimates.

†Please consult your local Jaguar Retailer for details of charges associated with option fitment. Weights reflect vehicles to standard specifications. Optional extras increase weight.

F-TYPE S JAGUAR 3.0 LITER V6 380 SUPERCHARGED PETROL AWD		F-TYPE R JAGUAR 5.0 LITER V8 550 SUPERCHARGED PETROL AWD		F-TYPE SVR JAGUAR 5.0 LITER V8 575 SUPERCHARGED PETROL AWD	
	6/4		8/4		8/4
	84.5/89		92.5/93		92.5/93
	2,995		5,000		5,000
	380		550		575
	6,500		6,500		6,500
	339		502		516
	3,500 - 5,000		3,500		3,500 - 5,000
	10.5		9.5		9.5
COUPE AUTOMATIC	CONVERTIBLE AUTOMATIC	COUPE AUTOMATIC	CONVERTIBLE AUTOMATIC	COUPE AUTOMATIC	CONVERTIBLE AUTOMATIC
4.9	4.9	3.9	3.9	3.5	3.5
171	171	186	186	200	195
COUPE AUTOMATIC	CONVERTIBLE AUTOMATIC	COUPE AUTOMATIC	CONVERTIBLE AUTOMATIC	COUPE AUTOMATIC	CONVERTIBLE AUTOMATIC
TBD	TBD	TBD	TBD	TBD	TBD
TBD	TBD	TBD	TBD	TBD	TBD
TBD	TBD	TBD	TBD	TBD	TBD
18.5	18.5	18.5	18.5	18.5	18.5
COUPE	CONVERTIBLE	COUPE	CONVERTIBLE	COUPE	CONVERTIBLE
176.0	176.0	176.0	176.0	176.2	176.2
80.4	80.4	80.4	80.4	80.4	80.4
74.2	74.2	74.2	74.2	74.2	74.2
51.6	51.5	51.6	51.5	51.6	51.5
103.2	103.2	103.2	103.2	103.2	103.2
62.9	62.9	62.4	62.4	62.4	62.4
64.9	64.9	64.1	64.1	63.4	63.4
4.1	4.1	3.9	3.9	4.2	4.2
35.0	35.0	35.0	35.0	35.0	35.0
—	7.3	—	7.3	—	7.3
10.9	—	10.9	—	10.9	—
14.4	—	14.4	—	14.4	—
COUPE AUTOMATIC	CONVERTIBLE AUTOMATIC	COUPE AUTOMATIC	CONVERTIBLE AUTOMATIC	COUPE AUTOMATIC	CONVERTIBLE AUTOMATIC
3,691	3,735	3,814	3,847	3,759	3,792
4,740	4,740	4,740	4,740	4,740	4,740

DIMENSIONS

Dimensions shown are based upon F-TYPE R, Coupe and Convertible.
For details of all derivatives please refer to the Technical Specifications page.

Overall Width (inc mirrors) 80.4 inches

Overall Width (exc mirrors) 74.2 inches

Trunk Volume 14.4 cu.ft (Coupe) 7.3 cu.ft (Convertible)



Turning Circle
Curb to Curb 35.0 ft.



VEHICLE SHOWN F-TYPE R IN POLARIS WHITE FEATURING OPTIONAL BLACK PACKAGE

JAGUAR EXPERIENCE

There's no better way to get to know Jaguar than by taking a drive. The Jaguar Experience offers a range of unique opportunities to really find out what it feels like to get the most out of a Jaguar. Our track experiences allow you to push yourself and cars from the incredible Jaguar range to the limit. Jaguar Experience also offers the opportunity to see a Jaguar brought to life during a tour of one of our UK manufacturing facilities.

Find out more by visiting JAGUARUSA.COM



BEHIND THE SCENES

Our factory tours give you the unique opportunity to experience the whole process of how our cars are brought to life - from the moulding of sheet metal to those intricate final touches. At our state-of-the-art production facilities, you'll get to see how skilled technicians and sophisticated machines work seamlessly together to perfect some of Jaguar's most breathtaking cars - from the powerful F-TYPE to the groundbreaking F-PACE performance SUV.

Find out more at JAGUARUSA.COM



DRIVING EXPERIENCES

The opportunity to drive the latest Jaguar cars at their limits, or relive iconic Jaguar history, is rare. Jaguar Driving Experiences offer unique driving adventures you will never forget. Imagine yourself behind the wheel of our highest performing Jaguar models, on a private track, with a Jaguar Experience Instructor at your side. This is the Jaguar Performance Driving Academy.

Find out more at JAGUARUSA.COM



ICONIC EXPERIENCES

Take your driving to the next level with our international adventures facing extreme on-road, and off-road, conditions. Our Iconic Experiences offer journeys and challenges that will test and develop your performance driving skills. Every year, Jaguar customers and enthusiasts join us for our luxury Ice Driving Experience. The exclusive ski resort in Gstaad, Switzerland, is the perfect location to enjoy the thrill of performance driving on ice. Our Ice Driving Experience is a two-day getaway held each winter. You can get a flavour of the event below. Then, if you'd like to be part of it in the next experience, we can keep you posted.

Find out more by visiting JAGUARUSA.COM

THE WORLD OF JAGUAR

Choose an F-TYPE and you're joining the exciting World of Jaguar. It makes owning and driving carefree and easy, as well as providing a range of exclusive services and lifestyle products.

JAGUAR ELITECARE

5 YEARS 60,000 MILES

- ④ New Vehicle Limited Warranty
- ⑤ Complimentary Scheduled Maintenance
- ⑥ 24-Hour Roadside Assistance
- ⑦ Jaguar InControl® Remote & Protect™

BEST IN CLASS COVERAGE*

JAGUAR ELITECARE

Enjoy your Jaguar with complete peace of mind.

The F-TYPE is now backed by the Best-In-Class Jaguar EliteCare*, our exceptional 5 year / 60,000 mile coverage program including New Vehicle Limited Warranty, Complimentary Scheduled Maintenance, Roadside Assistance and InControl Remote & Protect™.



NEW VEHICLE LIMITED WARRANTY

The New Vehicle Limited Warranty (the "Warranty") lets you enjoy your driving with peace of mind and runs for a best in class 5 years or 60,000 miles, whichever occurs first. The Warranty is fully transferable to subsequent owners and remains in effect throughout the Warranty coverage period.

*Class is cars sold by luxury automobile brands and claim is based on total package of warranty, maintenance and other coverage programs. For complete details regarding Jaguar EliteCare coverage, visit JAGUARUSA.COM, call 1.800.4.JAGUAR or visit your local Jaguar Retailer.

**Servicing your vehicle at the specified interval is critical to maintaining its long-term durability. Failure to perform scheduled maintenance within 1000 miles of the recommended interval may void the Warranty under certain circumstances.



COMPLIMENTARY SCHEDULED MAINTENANCE**

Relax in the knowledge that long-term performance is assured with the Complimentary Scheduled Maintenance Coverage. It covers factory recommended scheduled servicing as detailed in the "Passport to Service" for 5 years or 60,000 miles, whichever occurs first**. A Service Interval Indicator will appear every 16,000 miles or every 12 months, to remind you to take advantage of your complimentary maintenance.

GENUINE PARTS

Jaguar Genuine Parts are designed, tested and manufactured to our uncompromising standards for quality, fit and durability. Each part is engineered specifically for the F-TYPE to contribute to optimum performance and to help maximize its lifespan.



ROADSIDE ASSISTANCE

Jaguar Roadside Assistance provides assistance in motoring emergencies, from immobilization due to breakdown or accident to minor problems such as punctures. You can rely on our roadside assistance, whatever the situation, anywhere in North America during the vehicles warranty period.



JAGUAR MAGAZINE

Jaguar Magazine is the official magazine of Jaguar Cars. It features the Jaguar F-PACE, XE, XJ, XF and F-TYPE, and the worlds of luxury, style, design and travel.

JAGUAR COLLECTION

The latest range from the Jaguar Collection has been crafted with the same design execution and attention to detail that goes into all of our cars. This is evident in our clothing range, premium leather items and luxury travel goods. To celebrate Jaguar's heritage we also have a collection that honours past achievements and features race-inspired gift items and apparel. To find out more, please visit your local Jaguar Retailer.

GLOSSARY

A

ABS SYSTEM

This anti-lock braking system prevents wheel lock up under heavy braking to maintain vehicle control.

ACTIVE SPORTS EXHAUST

This system features active valves that, when open, allow the exhaust gases to exit via a more direct route producing a richer, more exhilarating noise. The system also allows the driver to use a button on the center console (if optioned) to manually activate the valves.

AMBIENT INTERIOR MOOD LIGHTING

Ambient Interior Mood Lighting headlamps many of the cabin's key features and design details in a relaxing soft phosphor blue glow.

C

CABIN CORRECTION ALGORITHM

Meridian's Cabin Correction Algorithm intelligently and discreetly optimizes the audio system to the precise acoustics of the vehicle cabin, preserving the natural rhythm of the performance.

CAE DEVELOPMENT PROCESS

Computer-Aided Engineering (CAE) is the usage of computer models and software to aid engineering analysis.

COMBUSTION CHAMBER

A Combustion Chamber is the part of an engine where the fuel and air mixture is burned.

D

DIE-CAST ALUMINUM BLOCKS

Die-casting is a metal casting process used to form the aluminum blocks for the engines. It involves forcing molten metal under high pressure into a mould. This allows for excellent dimensional accuracy and the casting of thinner walls.

DSP AMPLIFIER

Meridian's Digital Signal Processing (DSP) technology analyses a range of variables that may impact audio quality, then processes them using sophisticated algorithms and adapts the system's output accordingly. This enables a level of powerful, authentic performance impossible with a conventional sound system.

DUAL INDEPENDENT VARIABLE CAMSHAFT TIMING

Dual Independent Variable Camshaft Timing is a feature whereby the engine can adjust the timing of both the intake and exhaust valves independently. This allows for improved power and torque, particularly at lower engine revs, as well as improved fuel economy and reduced emissions.

DAMPERS/DAMPING

Dampers absorb forces acting on the suspension for greater ride comfort and control. Dampers are also known as shock absorbers.

F

FORGED ALUMINUM DOUBLE WISHBONE SUSPENSION

The front and rear double wishbone suspension is an independent suspension design using two wishbone-shaped arms to place the wheel. Double wishbone designs deliver precise handling and steering response.

I

INCONEL®

Inconel is a family of austenite nickel-chromium-based superalloys. Inconel alloys are oxidation and corrosion resistant materials well suited for service in extreme environments subjected to pressure and heat.

INTELLIGENT STOP/START

Stop/Start is a technology that stops the engine when it is not needed, improving the fuel economy and reducing the car's CO₂ emissions. The engine will restart immediately as soon as the driver's foot comes off the brake pedal. The engine will be operating at full capacity before the driver's foot has touched the accelerator pedal.

M

MANUAL MODE

Manual Mode is a mode available on automatic transmissions that allows you to manually upshift and downshift.

MERIDIAN TRIFIELD TECHNOLOGY

Meridian's exclusive Trifield technology delivers a consistent, concert-like experience, optimized for all seating positions.

MONOBLOC CALIPERS

Monobloc Calipers are forged from one piece of metal. This makes them more resistant to flex under load, so they waste less energy and deliver consistent braking feel.

MULTI-PLATE CLUTCH

A Multi-plate Clutch uses several friction discs to transmit power from the engine to the transmission. This decreases drag and increases the amount of torque that is transmitted while minimizing the amount of force needed to operate the clutch, enabling faster and smoother shifting.

S

SHORT-THROW GEAR LEVER

A short-throw gear lever has a reduced length to enable swifter gear changes.

X

XENON HEADLAMPS

Bi-function Xenon headlamps offer improved illumination and feature LED 'J' Blade Daytime Running Lamps for a striking on-road style.

DISCLAIMERS

¹Do not use Jaguar InControl® features under conditions that will affect your safety or the safety of others. Driving while distracted can result in loss of vehicle control.

²Driving while distracted can result in loss of vehicle control. Do not operate, adjust or view the navigation or multimedia systems under conditions that will affect your safety or the safety of others. Only use mobile phones, and other devices, even with voice commands, when it is safe to do so.

³The Wi-Fi hotspot is intended for passenger use only. InControl® features may require an additional subscription with separate terms and conditions.

⁴A 3-month trial subscription to the SiriusXM® All Access package is included with the vehicle, which gives you access to 175+ channels of premium programming. Plus you can stream SiriusXM® on your computer, smartphone or tablet - it's included in your trial. If you decide to continue service after your trial, the subscription plan you choose will automatically renew thereafter and you will be charged according to your chosen payment method at then-current rates. Fees and taxes apply. To cancel you must call SiriusXM® at 1-866-635-2349. See the SiriusXM® Customer Agreement for complete terms at siriusxm.com. All fees and programming are subject to change. SiriusXM® Satellite Radio is not available in Alaska, Hawaii, or Puerto Rico.

⁵These features are not a substitute for driving safely with due care and attention and will not function under all circumstances, speeds, weather and road conditions, etc. Driver should not assume that these features will correct errors of judgment in driving. Please consult the owner's manual or your local Jaguar Retailer for more details.

⁶Please remember that the safety belts in a vehicle constitute the primary protection system for driver and passengers in collisions. Airbags are not designed to deploy in all collisions. The airbag Supplemental Restraint System (SRS) is a supplement to the safety belts and is designed to work as a system with the safety belts. Although airbags provide additional protection, airbags without safety belts do not provide optimal protection in a crash. Always wear your safety belts. Children younger than 13 years old should always be properly restrained in a back seat, away from airbags. Never place an infant seat in the front seat.

⁷All figures are EPA estimates. Actual mileage may vary.

⁸Always follow local speed limits.



IMPORTANT NOTICE

Jaguar Land Rover Limited is constantly seeking ways to improve the specification, design and production of its vehicles and alterations take place continually. While every effort is made to produce up-to-date literature, this brochure should not be regarded as an infallible guide to current specifications, nor does it constitute an offer for the sale of any particular vehicle. Distributors and Retailers are not agents of Jaguar Land Rover Limited by any express or implied undertaking or representation. Comparisons are based on manufacturer's own data and testing prior to publication.

COLORS

Print and online colors are representative only.

ENVIRONMENTAL INNOVATION AT JAGUAR

F-PACE, XF, XE, XJ and F-TYPE innovative use of lightweight aluminum, which incorporates up to 50% closed-loop recycled material from the manufacturing process of the body structures, provides considerable performance benefits. This includes improved fuel consumption and less CO₂ emissions during the use phase of the Life Cycle due to lighter structures. Our on-going target is to ensure scrap aluminum reclaimed from our stamping process is to be segregated and recycled through a closed loop system and incorporated back into the same grade quality aluminum sheet, therefore reducing CO₂ emissions, versus the use of virgin aluminum sheets, during the production phase of the Life Cycle.

Jaguar is committed to reducing dependency on fossil fuels, using fewer natural resources and creating less waste as part of our approach to responsible and sustainable business development, called Environmental Innovation.

The company plan includes ongoing reduction in CO₂ emissions and the use of natural resources and at the end of 2014 we have achieved a 28% reduction in operating CO₂ emissions, 25% in the Company's European fleet average tailpipe emissions, 75% in waste to landfill, logistics efficiencies (18%) and water consumption (10%), all based on per vehicle built since 2007. In addition the manufacturing assembly CO₂ emissions of each Jaguar built in the UK since 2009, is 100% offset as part of our 2020 strategy for carbon neutral manufacturing assembly and since 2013 carbon-for-development projects form a key part of the company's Global Corporate Social Responsibility (CSR) programme.

For each tonne of CO₂ emitted in the assembly process, the company invests in emissions reductions projects that reduce an equivalent tonne of CO₂ elsewhere and provide social and humanitarian benefits at the same time.

Since 2013 the programme has offset 800,000 tonnes of CO₂ and improved the lives of over 2 million people from our award winning Lifestraw carbon-for-water emissions reduction programme. Taking into account the company's global sales growth and increased investment in more efficient operating facilities, we are proud to have delivered and in some cases exceeded our Environmental Innovation targets as planned between 2012-2015.

But it doesn't stop there. Our manufacturing facilities have been certified to ISO14001 since 1998 and in 2013 the Company was recognised as the UK's Responsible Business of the Year by leading CR index, Business in the Community. In 2014 we built on this success through the Queen's award for Enterprise in Sustainable Development for 2014.

Looking forward, we have developed our 2020 vision for sustainable business growth that focuses on continued improvements in operating and tailpipe CO₂ emissions, carbon neutral manufacturing and zero waste. The company will also improve the lives of 12 million people by 2020 as part of the global Corporate Social Responsibility programme.

Meridian is the registered trademark of Meridian Audio Ltd.

The Bluetooth® word mark and logos are owned by the Bluetooth SIG, Inc. and any use of such marks by Jaguar Land Rover Limited is under license.

iPod and iPhone are a trademark of Apple Inc, registered in the US and other countries.

SOME OF THE VEHICLES FEATURED IN THE PHOTOGRAPHS THROUGHOUT THIS BROCHURE ARE EUROPEAN MODELS AND MAY NOT BE AVAILABLE IN NORTH AMERICA. PLEASE CONSULT YOUR LOCAL JAGUAR RETAILER FOR SPECIFIC MODEL AVAILABILITY.

**VEHICLE SHOWN FRONT COVER: F-TYPE SVR IN FIRESAND WITH OPTIONAL FEATURES FITTED
VEHICLE SHOWN BACK COVER: F-TYPE SVR IN AMMONITE GREY WITH OPTIONAL FEATURES FITTED**

Jaguar Land Rover North America LLC
555 MacArthur Boulevard
Mahwah, NJ 07430-2327
JAGUARUSA.COM

March 2016/17MY
JLM/09/02/12/0316

