

JAGUAR XE 2019



THE ART OF PERFORMANCE





BY APPOINTMENT TO
HM THE QUEEN
MANUFACTURERS OF
MOTOR VEHICLES
JAGUAR LAND ROVER LIMITED
COVENTRY



BY APPOINTMENT TO
HRH THE DUKE OF EDINBURGH
MANUFACTURERS OF
MOTOR VEHICLES
JAGUAR LAND ROVER LIMITED
COVENTRY



BY APPOINTMENT TO
HRH THE PRINCE OF WALES
MANUFACTURERS OF
MOTOR VEHICLES
JAGUAR LAND ROVER LIMITED
COVENTRY



JAGUAR

THE ART OF PERFORMANCE

Every day we push performance to its limit. Our performance. Our cars' performance.
We innovate, we engineer, we design. We master rules and then break them.
Only to push further. Past the limits of convention. This is when performance becomes art.

Jaguar. The Art of Performance.



CONTENTS

INTRODUCTION

| | |
|-----------------------|----|
| The Concept of the XE | 07 |
| The XE - The Facts | 08 |

DESIGN

| | |
|---------------------|----|
| Exterior Principles | 10 |
| Exterior Detail | 12 |
| Interior | 17 |

PERFORMANCE

| | |
|-----------------------------------|----|
| Engines | 18 |
| Advanced Aerodynamics | 22 |
| Lightweight Aluminum Architecture | 25 |
| Chassis and Suspension | 26 |

DRIVING TECHNOLOGY

| | |
|--------------------------------|----|
| Advanced Driving Dynamics | 29 |
| Added Driver Confidence | 30 |
| Advanced Drivetrain Technology | 33 |
| Torque Vectoring | 35 |
| Stability and Control | 36 |

JAGUAR INCONTROL® TECHNOLOGIES

| | |
|--------------|----|
| Infotainment | 39 |
| Connectivity | 40 |
| Audio | 44 |

ASSISTANCE AND EFFICIENCY

| | |
|------------------------|----|
| Driver Assistance | 46 |
| Efficient Technologies | 49 |

XE LANDMARK EDITION

50

PERSONALIZATION

| | |
|--|----|
| The XE - Your Choice | 52 |
| Choose your Engine | 54 |
| Choose your Model | 56 |
| Choose your Options | 58 |
| Choose your Color | 64 |
| Choose your Wheels | 66 |
| Choose your Interior | 68 |
| Choose your Jaguar Gear - Accessories | 84 |

TECHNICAL DETAILS

86

SPECIAL VEHICLE OPERATIONS

92

THE WORLD OF JAGUAR

94

AT YOUR SERVICE

97





INTRODUCTION

THE CONCEPT OF THE XE

The Jaguar XE is the foundation of the Jaguar sedan car family. A distillation of the design, luxury and technology found in the Jaguar XF and the Jaguar XJ. Inspired by the Jaguar F-TYPE sports car, with its assertive looks and agile drive.

The XE range features an extended engine choice, including the 2.0 liter 4-cylinder 250HP Turbocharged Ingenium Gas engine and the 300HP Turbocharged Ingenium Gas engine - both deliver outstanding usable power and torque. There's also the 2.0 liter 4-cylinder 180HP Twin Turbocharged Ingenium Diesel engine offering effortless performance. Or choose the dynamic 3.0 liter 380HP V6 Supercharged Gas engine and bring the 0-60 mph time down to 4.8 seconds*.

The XE is an exceptional blend of technology, design, and driving dynamics that rewrites all the rules.

*Always follow local speed limits.

VEHICLE SHOWN: JAGUAR XE S IN FIRENZE RED WITH OPTIONAL EQUIPMENT

THE XE - THE FACTS

The XE brings together the latest Jaguar innovation, technology and design.

PERFORMANCE AND CHOICE

Find your perfect match in the range of gas and diesel engines offered in the Jaguar XE. There are three gas and one diesel engines from our state-of-the-art Ingenium range. All deliver strong, high-torque performance. In addition, the 2.0 liter 4-cylinder 300HP engines deliver significant reduction in turbo lag to improve engine response. But if pure power is your preference, then XE S with its 380HP V6 Gas engine should satisfy: from a standstill it can reach 60 mph in 4.8 seconds*.

CAPABILITY

The XE offers our unique All Wheel Drive with Intelligent Driveline Dynamics and Adaptive Surface Response. Available with selected engines, these systems are designed to enhance the legendary Jaguar handling, agility and ride, and to give added assistance**.

*Always follow local speed limits.

**These systems are not a substitute for driving safely with due care and attention and will not function under all circumstances, speeds, weather and road conditions, etc. Driver should not assume that these features will correct errors of judgment in driving. Please consult the owner's manual or your local authorized Jaguar Retailer for more details.

†All in-car features should be used by drivers only when safe to do so. Drivers must ensure they are in full control of the vehicle at all times.

‡Requires Navigation Pro. †Requires 360° Parking Aid. ‡Requires powerfold mirrors. †Not available on XE base model.

‡Not available on XE base and XE Premium models.

VEHICLE SHOWN: JAGUAR XE S IN FIRENZE RED WITH OPTIONAL EQUIPMENT

ADDED INTELLIGENCE

Innovative technologies make every drive easier and enjoyable. The XE offers the option of adaptive Xenon headlights with LED signature, Traffic Sign Recognition and Adaptive Speed Limiter¹, Lane Keep Assist with Driver Condition Monitor, Emergency Braking[‡], Adaptive Cruise Control with Queue Assist, Park Assist², and Blind Spot Assist^{**3}. With the available Powered gesture trunk lid you can access the trunk when your hands are full. Simply present your foot under either rear corner and the trunk opens or closes.

ALWAYS CONNECTED[†]

Our most advanced infotainment system ever - Jaguar InControl[®] Touch Pro including a 10" Touchscreen in the center console - now features as standard^{††} on XE. Its next-generation hardware and software enhances every journey through added connectivity, convenience and entertainment. Some of the outstanding features it supports include Meridian[™] Sound Systems⁴, connected navigation and 12.3" Interactive Driver Display⁵.



LIGHTWEIGHT ALUMINUM ARCHITECTURE

The lightweight architecture of the XE creates a strong body - underpinning power with responsive handling, and refinement with beautiful design.

^{††}Driving while distracted can result in loss of vehicle control. Do not operate, adjust or view the navigation or multimedia systems under conditions that will affect your safety or the safety of others. Only use mobile phones and other devices, even with voice commands, when it is safe to do so.

[‡]Please note that if any action is taken, even minimal steering, the Emergency Braking system will assume the driver resumed control of the vehicle and the system will automatically disengage.



DESIGN EXTERIOR PRINCIPLES

➤ DYNAMIC PROPORTIONS | MUSCULAR LOOKS

"It's about paring it down to the bare essentials. Good designers have always said less is more."
Ian Callum, Jaguar Design Director.

The XE stands out from the competition with the clean surfaces and dynamic looks that form the core of Jaguar design. This is because the Lightweight Aluminum Architecture gave its designers the freedom to work alongside engineers to optimize the car's proportions – The XE is unmistakably a Jaguar. The long, distinctly defined hood is aerodynamically sculpted to channel air over and around the body for greater efficiency. Along with the rising waistline and 'cab rearward' design, it ensures that the XE shares the athleticism of the other cars in the Jaguar range. The XE is crouching, ready to pounce.

VEHICLE SHOWN RIGHT: JAGUAR XE S IN FIRENZE RED WITH OPTIONAL EQUIPMENT



EXTERIOR DETAIL

INNOVATIVE DESIGN

One glance at XE and you know that it could only be a Jaguar. From the headlights featuring Jaguar signature 'J' blade Daytime Running Lights*, the powerfully sculpted hood, and the chrome side vents, stamped with the Jaguar name, all the way to those distinctive rear haunches. Only Jaguar, as a world leader in aluminum car construction, has the technology and expertise to create sharper creases from deeper, more innovatively formed pressings. The body side curvature of XE is aerodynamically honed to sweep air seamlessly rearwards to the tail. The deliberately cropped rear has a short overhang, underscoring the car's performance credentials and enhancing airflow. It culminates with those iconic tail lights that are inspired by the F-TYPE sports car.

*Available with Adaptive Xenon headlights only.

VEHICLE SHOWN: JAGUAR XE R-SPORT IN CAESIUM BLUE WITH OPTIONAL EQUIPMENT













INTERIOR



COCKPIT FEEL

EXTENSIVE CHOICE

Connect with XE the moment you slide into the form-hugging seats – you sit low in a Jaguar. The raised center console adds to the cockpit feel.

Pulsing with a heartbeat, the car creates an emotional connection between driver and machine. Its 72 per minute double beat is similar to a jaguar cat at rest. Press the Start button and XE awakes, the needles sweep*, the engine growls. The JaguarDrive Selector™ rises to greet your hand. The outer air vents are unique in the way that they extend the fascia to nestle in the door casings and give the feeling of width and space.

Throughout XE the natural forms of the interior architecture lend themselves to the extensive choice of contemporary or traditional materials and finishes. XE is an inspired place for driver and passengers to be.

*Needle sweep is not available when optional Interactive Driver Display is specified.

INTERIOR SHOWN LEFT AND PREVIOUS PAGE: XE LANDMARK EDITION FEATURING EBONY/EBONY WITH LIGHT OYSTER CONTRAST TWIN-NEEDLE STITCH WITH OPTIONAL EQUIPMENT

PERFORMANCE ENGINES



INGENIUM ENGINES

STOP/START TECHNOLOGY

Ingenium technology underpins most engines in the XE range. These low friction, all-aluminum engines have stiff cylinder blocks and twin balancer shafts to ensure inherently low levels of vibration, for smooth day-to-day performance. All engines are equipped with Stop/Start technology and smart regenerative charging – harvesting kinetic energy from braking to charge the battery.



INGENIUM DIESEL ENGINE

317 lb-ft of Torque

The **Ingenium 2.0 liter 4-cylinder 180HP Turbocharged Diesel** engine offers impressive performance and economy. For an engine of this size it offers high levels of torque and balance, achieved thanks to its variable geometry turbocharger. Adapting to the changing flow of exhaust gases, it maximizes low speed torque for broad power and responsiveness that is uniform, progressive and avoids lag.

*Always follow local speed limits.



INGENIUM GAS ENGINE

0-60 mph from 5.4 seconds*

The **Ingenium 2.0 liter 4-cylinder Turbocharged** is available in two power outputs – 247HP and 296HP. These engines provide impressive power and balance. With almost instant boost, its low inertia twin-scroll turbocharger features low-friction ball bearings and a high flow compressor wheel and is fed by an integrated exhaust manifold that synchronizes exhaust pulses from two separate pairs of cylinders – reducing turbo lag and improving engine response. Underpinned by the turbocharger's increased aerodynamic efficiency, the engine delivers outstanding usable power and torque.

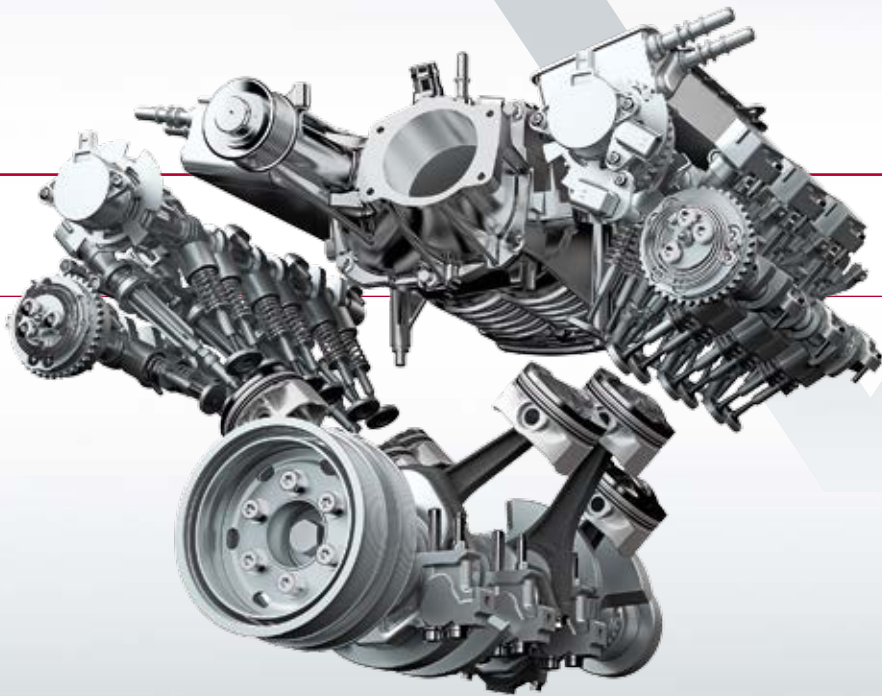

SUPERCHARGED GAS ENGINE

0-60 mph from 4.8 seconds*

The **3.0 liter V6 380HP Supercharged Gas** engine features a Roots-type twin vortex supercharger that provides linear delivery of power and maximizes responsiveness. This results in performance matching much larger engines, while optimizing economy and reducing emissions. The engine also features dual independent variable cam timing to vary inlet and exhaust valve operation, working alongside lightweight pistons with ultra-low friction piston rings, for increased performance. For added refinement there is a twin, contra-rotating balancer shaft system.

*Always follow local speed limits.

VEHICLE SHOWN: JAGUAR XE S IN YULONG WHITE WITH OPTIONAL EQUIPMENT



ADVANCED AERODYNAMICS

ADVANCED AERODYNAMICS

The XE form has been rigorously optimized for aerodynamic efficiency and stability. The XE cuts through the air - helping to reduce fuel consumption and lower emissions. Every element exploits the exterior's maximum aerodynamic potential while preserving the stunning proportions of the XE. Vertical apertures in the front bumper's outer edges channel air through vents in the wheel arches and out over the front wheels. Even the race car-inspired underbody protection and diffuser is designed to make the XE as economical and refined as possible.

VEHICLE SHOWN: JAGUAR XE R-SPORT IN CAESIUM BLUE WITH OPTIONAL EQUIPMENT



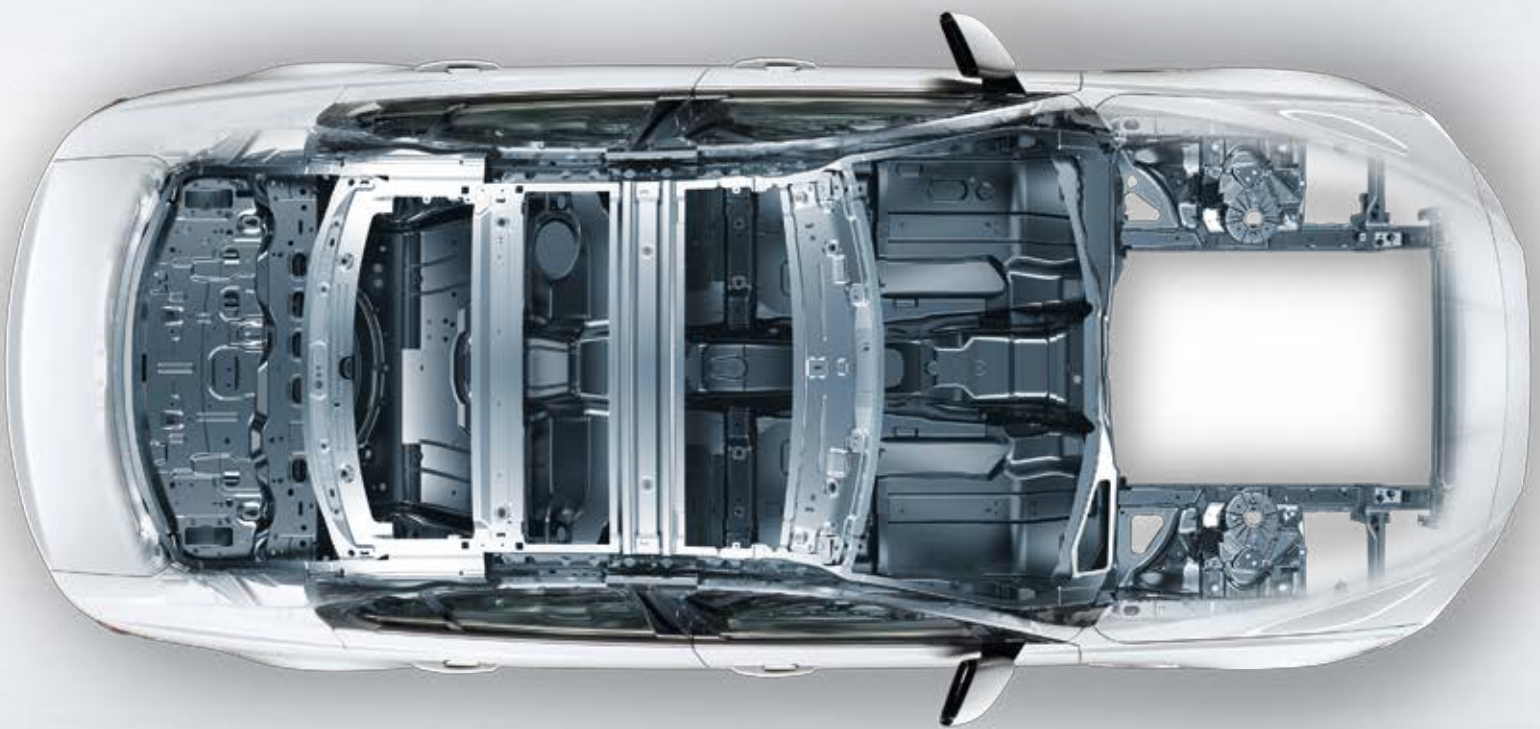

LIGHTWEIGHT ALUMINUM ARCHITECTURE

 **BALANCED** | **STRONG AND LIGHTWEIGHT**

Jaguar Land Rover has been at the forefront of aluminum car construction for more than a decade and continues to push the boundaries of this technology. As part of our pioneering recycled aluminum project, we've reclaimed over 50,000 tons of aluminum scrap - the mass of 200,000 XE bodyshells - back into the production process during 2015/16. This has prevented more than the equivalent of 500,000 tons of CO₂ from entering the atmosphere.

The XE is based on our Lightweight Aluminum Architecture, which uses expertise derived from the aerospace industry to deliver premium vehicle characteristics in performance and refinement. This strong bodyshell uses a high strength 6000 series aluminum alloy. Saving weight without compromising durability, it provides very high torsional stiffness, supporting precise handling. It helps achieve optimum weight distribution approaching 50:50.

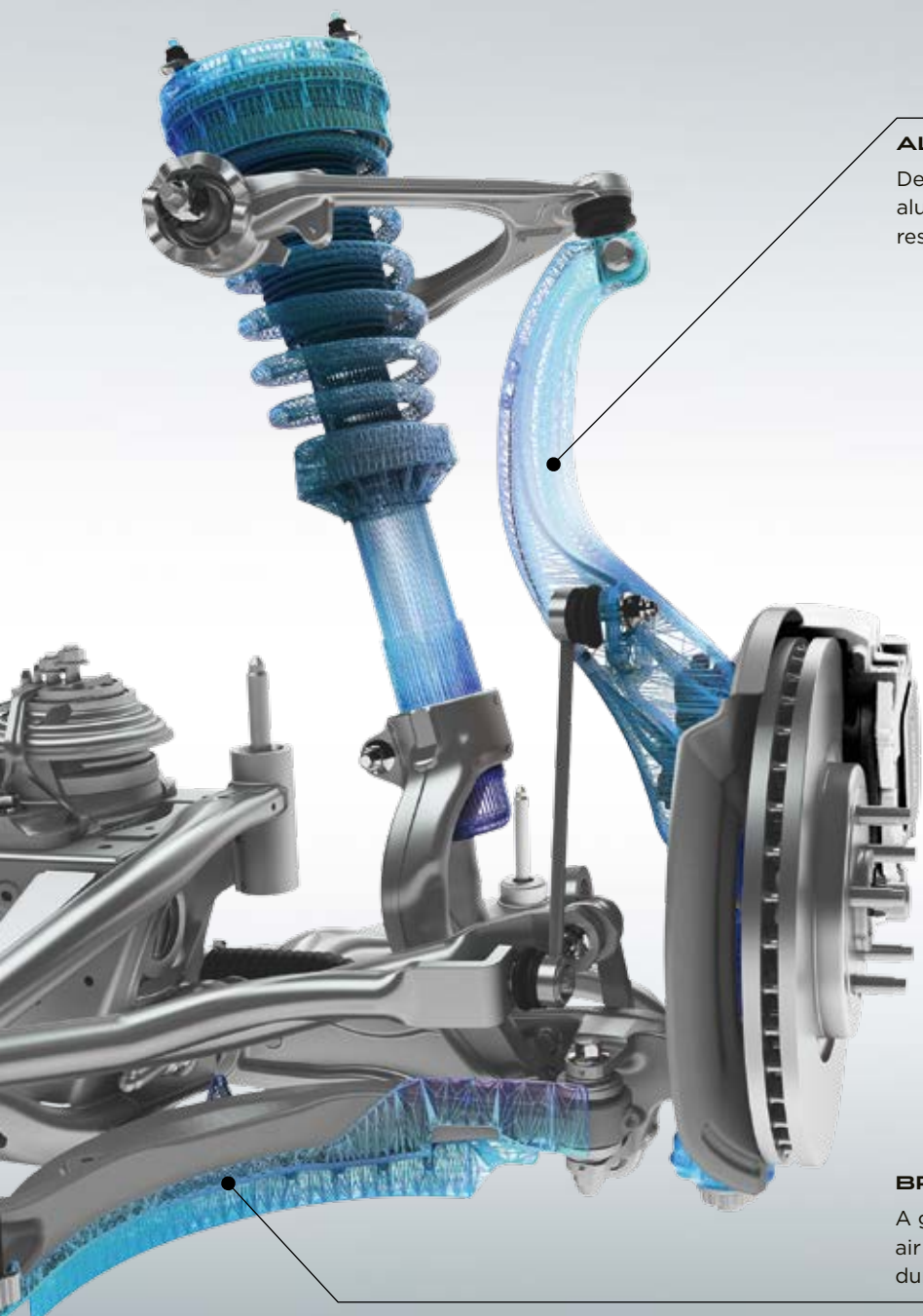

ALUMINUM FRONT KNUCKLE

Designed to enhance stiffness and strength, the lightweight aluminum front knuckle helps improve XE agility, responsiveness and refinement for sports-car-like control.

CHASSIS AND SUSPENSION



UNIQUE SUSPENSION
TECHNOLOGY

COMFORTABLE
AND DYNAMIC

The XE responds with agility and performs with dynamism while maintaining ride comfort - it's a unique balance that makes it a Jaguar. The ideal foundation for these driving dynamics is light, yet strong and stiff, Lightweight Aluminum Architecture with its near 50:50 weight distribution.

The sophisticated front and rear suspension systems complete a chassis that achieves a superb combination of sportiness and refinement. Advanced damper technologies - both passive and adaptive - further improve ride quality and extend the XE breadth of dynamic capabilities. The suspension's control, agility and feedback give the XE the spirit of a sports car.

BRAKE SCOOP

A glass-filled polypropylene brake scoop channels air onto the brakes for enhanced brake performance during enthusiastic driving.

*Not available on XE and XE Premium. Requires fitment of Configurable Dynamics.

*These systems are not a substitute for driving safely with due care and attention and will not function under all circumstances, speeds, weather and road conditions, etc. Driver should not assume that these features will correct errors of judgment in driving. Please consult the owner's manual or your local authorized Jaguar Retailer for more details.

INTEGRAL LINK REAR SUSPENSION

Integral Link rear suspension allows the XE to realize a combination of a refined, luxurious ride and sharp, responsive handling. The system separates and independently manages the lateral, longitudinal and vertical forces acting on the suspension for enhanced control and comfort. Many components are forged or hollow-cast in aluminum – the optimum production techniques for strong, lightweight suspension.

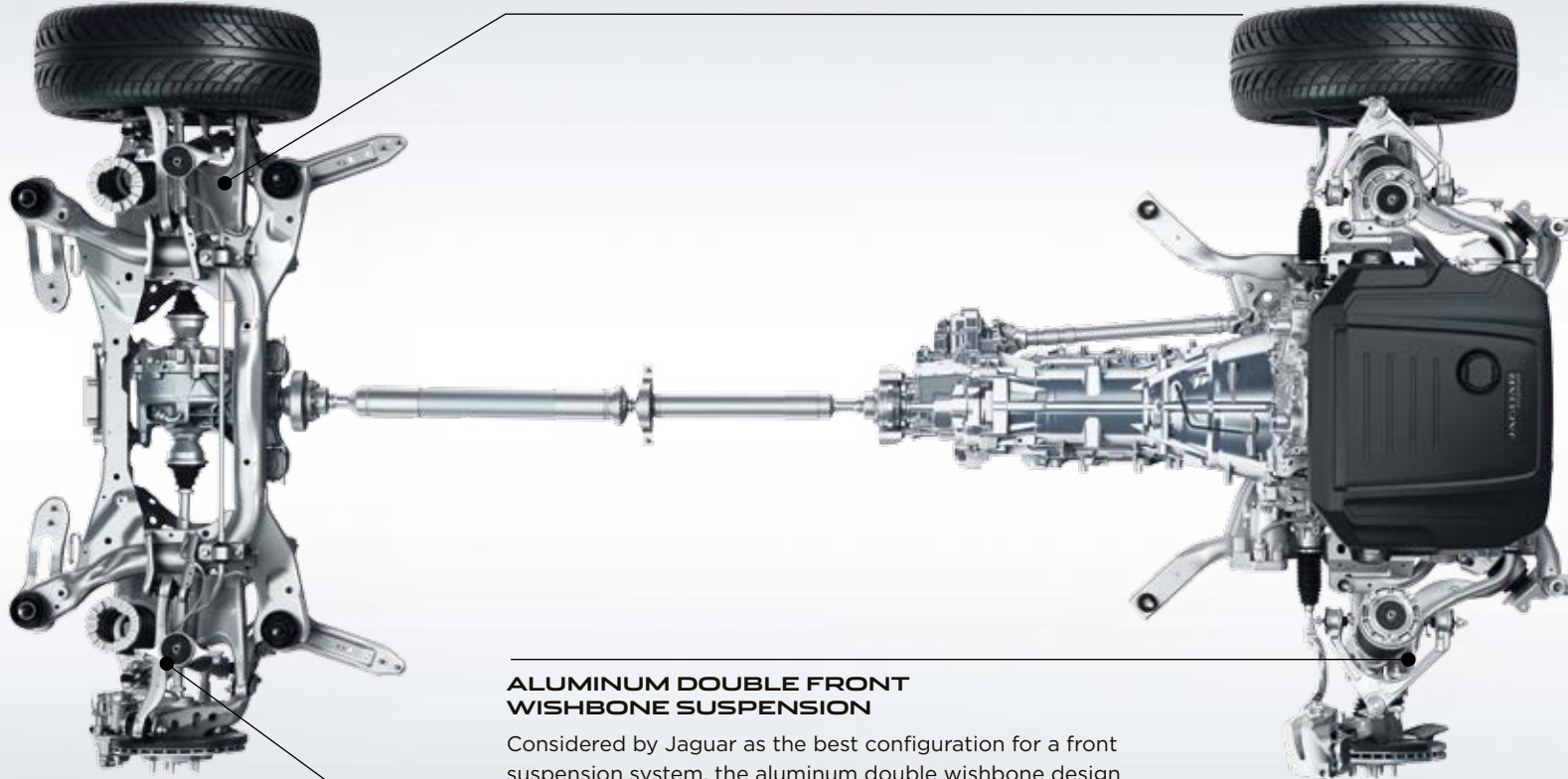

ALUMINUM DOUBLE FRONT WISHBONE SUSPENSION

Considered by Jaguar as the best configuration for a front suspension system, the aluminum double wishbone design is modeled closely on the F-TYPE for precise handling and steering response.

ADAPTIVE DYNAMICS¹

The optional Adaptive Dynamics system delivers both precise dynamics and a supple, luxurious ride by monitoring wheel position and body movements. The system constantly monitors conditions and adjusts the dampers to provide the optimum balance between comfort and refinement at all times*.



DRIVING TECHNOLOGY ADVANCED DRIVING DYNAMICS



ENHANCING AGILITY

CONTINUOUSLY ADAPTING

Dynamic Mode revises the car's software to further enhance the sporting character. It sharpens the throttle response, increases steering weighting and performs gearshifts more quickly and at higher engine speeds. It also brings visual drama to the driver as the instrument cluster takes on a red glow. Dynamic Mode enhances your connection with the inherent Jaguar performance.

ELECTRIC POWER ASSISTED STEERING

Electric Power Assisted Steering (EPAS) offers outstanding feedback, control and it is active on demand - saving power for where you really need it. EPAS' sophisticated computer management varies steering assistance as appropriate - increasing assistance for low speed maneuvering and improving feel at higher speeds. It also enables advanced driver assistance features such as Lane Keep Assist and Park Assist*.

ADAPTIVE DYNAMICS^{1 2}

Whether you're accelerating on the highway, cornering on country roads or navigating around town, optional Adaptive Dynamics modifies the response to match the conditions and your driving style. It analyzes acceleration, cornering, throttle and brake pedal activity, as well as kick-down activation. Steering movement is analyzed up to 500 times a second and body movement up to 100 times a second. Using this information, electronically controlled adaptive dampers then constantly adjust to optimize the suspension settings and maintain the poise and comfort of the XE*.

CONFIGURABLE DYNAMICS^{1 3 4}

Bringing technology from the F-TYPE, the optional Configurable Dynamics system allows you to set up the dynamics for throttle mapping, gearbox shift points, steering and damper settings to suit your performance driving needs.

¹Not available on XE and XE Premium models. ²Only available with optional Configurable Dynamics. ³Standard and only available on XE S AWD. ⁴Only available with Adaptive Dynamics.

*These systems are not a substitute for driving safely with due care and attention and will not function under all circumstances, speeds, weather and road conditions, etc. Driver should not assume that these features will correct errors of judgment in driving. Please consult the owner's manual or your local authorized Jaguar Retailer for more details.

ADDED DRIVER CONFIDENCE



ALL SURFACE PROGRESS CONTROL

ADAPTIVE SURFACE RESPONSE¹

The All Surface Progress Control (ASPC) developed by Jaguar is a low speed cruise control that helps the XE cope with low traction situations. ASPC allows the driver to concentrate more on steering the vehicle. Once activated, you use the cruise control buttons to set a 'target' speed of between 2.2 mph and 18.6 mph. The system then works to achieve and maintain that speed while exerting traction control*.

ASPC is standard and gives the XE drivers added assistance over slippery, loose surfaces, undulating terrain and even while descending a difficult incline. It helps make the XE easier to drive in challenging conditions. ASPC also has a pull-away function allowing the XE to progress from rest on low grip surfaces and ascending gradients, as well as a hill descent function that helps control vehicle speed on steeper inclines*.

On XE S AWD vehicles standard Adaptive Surface Response (AdSR) is designed to recognize differences between surfaces to exploit the optimal available grip. Drawing on Jaguar Land Rover's unrivaled expertise with All Wheel Drive systems, AdSR constantly monitors the car's environment and is designed to adjust the appropriate engine and brake settings. Once selected, AdSR works at all speeds to support you in adverse weather and across challenging surfaces*.

¹Standard and only available on XE S AWD.

*These systems are not a substitute for driving safely with due care and attention and will not function under all circumstances, speeds, weather and road conditions, etc. Driver should not assume that these features will correct errors of judgment in driving. Please consult the owner's manual or your local authorized Jaguar Retailer for more details.

Fitting All Season or Winter tires to the XE can improve capability on slippery surfaces.

MUD/GRAVEL



WET GRASS



SNOW



WET ROAD

DRY ROAD CONDITIONS

In normal conditions, torque is distributed to the rear wheels, delivering acclaimed Jaguar agility and handling.

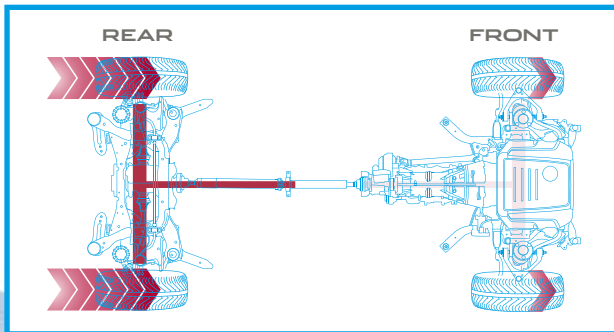

LOW TRACTION CONDITIONS

On slippery surfaces, such as grass and snow, torque can be balanced between the front and rear wheels to enhance traction.

In extreme conditions where only the front wheels have traction, up to 100 percent of engine torque can be distributed to the front wheels for more optimal grip.

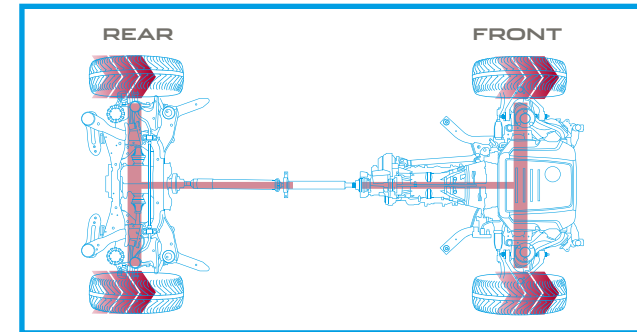

ADVANCED DRIVETRAIN TECHNOLOGY



ALL WHEEL DRIVE

INTELLIGENT DRIVELINE DYNAMICS

The XE All Wheel Drive (AWD) system combines the agility and character of Rear Wheel Drive (RWD) with the increased assistance and traction provided by AWD. In normal driving, the XE is predominantly RWD to deliver handling purity, feel and balance. But when roads become more challenging, or when you accelerate more on low-grip surfaces, the system subtly channels power forwards enabling the XE to maintain improved traction for comfortable progress in various conditions*.

The XE AWD uses a transfer case at the back of the 8-speed Automatic Transmission to manage the appropriate distribution of torque to the front and rear wheels. Engineered to ensure that the XE retains the dynamic behavior of a Jaguar car, the transfer case contains an electro-mechanically activated multi-plate clutch with an actuator to build hydraulic pressure. This pressure is quickly and accurately controlled to generate the required force in the clutch to transfer the optimal amount of torque to the front wheels. Unlike other systems that react to wheel slip, Jaguar's Intelligent Driveline Dynamics (IDD) software is predictive and uses sensors measuring throttle and steering inputs to anticipate wheel slip. IDD seamlessly co-ordinates these inputs and compares them with responses from the engine, transmission and traction control systems to calculate the traction available and distribute torque accordingly even before grip is lost*.

The result is a drive which blends the character of RWD with the capability of AWD, providing outstanding levels of performance and control.

*These systems are not a substitute for driving safely with due care and attention and will not function under all circumstances, speeds, weather and road conditions, etc. Driver should not assume that these features will correct errors of judgment in driving. Please consult the owner's manual or your local authorized Jaguar Retailer for more details.



TORQUE VECTORING APPLIES
BRAKE PRESSURE TO SLOW THE
INSIDE FRONT AND INSIDE REAR
WHEELS INDEPENDENTLY.

POWER IS SUSTAINED
TO MAINTAIN CONSTANT
SPEED OF OUTER WHEELS.

TORQUE VECTORING



ENHANCED CORNERING CAPABILITY

Torque Vectoring by Braking improves capability through even the tightest of corners. Torque Vectoring technology provides controlled independent braking on the individual inside front and rear wheels to add to the turning forces acting on the car. In most conditions more braking pressure is applied to the rear inside wheel as this supports the most increased cornering capability, while the front inside wheel is braked for greater effectiveness and refinement. The result is reduced understeer for sharper turning and more consistent road holding. Torque Vectoring delivers increased sports car-like agility and added driver confidence*.

ADDITIONAL ROTATIONAL
FORCE APPLIED AROUND
VEHICLE'S AXIS.

*These systems are not a substitute for driving safely with due care and attention and will not function under all circumstances, speeds, weather and road conditions, etc. Driver should not assume that these features will correct errors of judgment in driving. Please consult the owner's manual or your local authorized Jaguar Retailer for more details.

VEHICLE SHOWN: JAGUAR XE S IN FIRENZE RED WITH OPTIONAL EQUIPMENT

STABILITY AND CONTROL



DYNAMIC
STABILITY CONTROL

ENGINE DRAG
TORQUE CONTROL

The stability systems are designed to keep the XE balanced whether you're driving enthusiastically or simply want some reassurance in challenging conditions.

Dynamic Stability Control (DSC) monitors the dynamic behavior of the XE, intervening to assist vehicle stability and improving available grip. DSC is designed to reduce engine torque and to apply braking to the appropriate wheels to correct the car's direction of travel by counteracting understeer or oversteer. The XE DSC system has enhanced understeer control to help reduce speed and regain control more effectively*.

Engine Drag Torque Control (EDC) mitigates the chance of wheel slip caused by strong engine braking in adverse driving conditions. It acts by briefly increasing torque to the wheels as appropriate*.

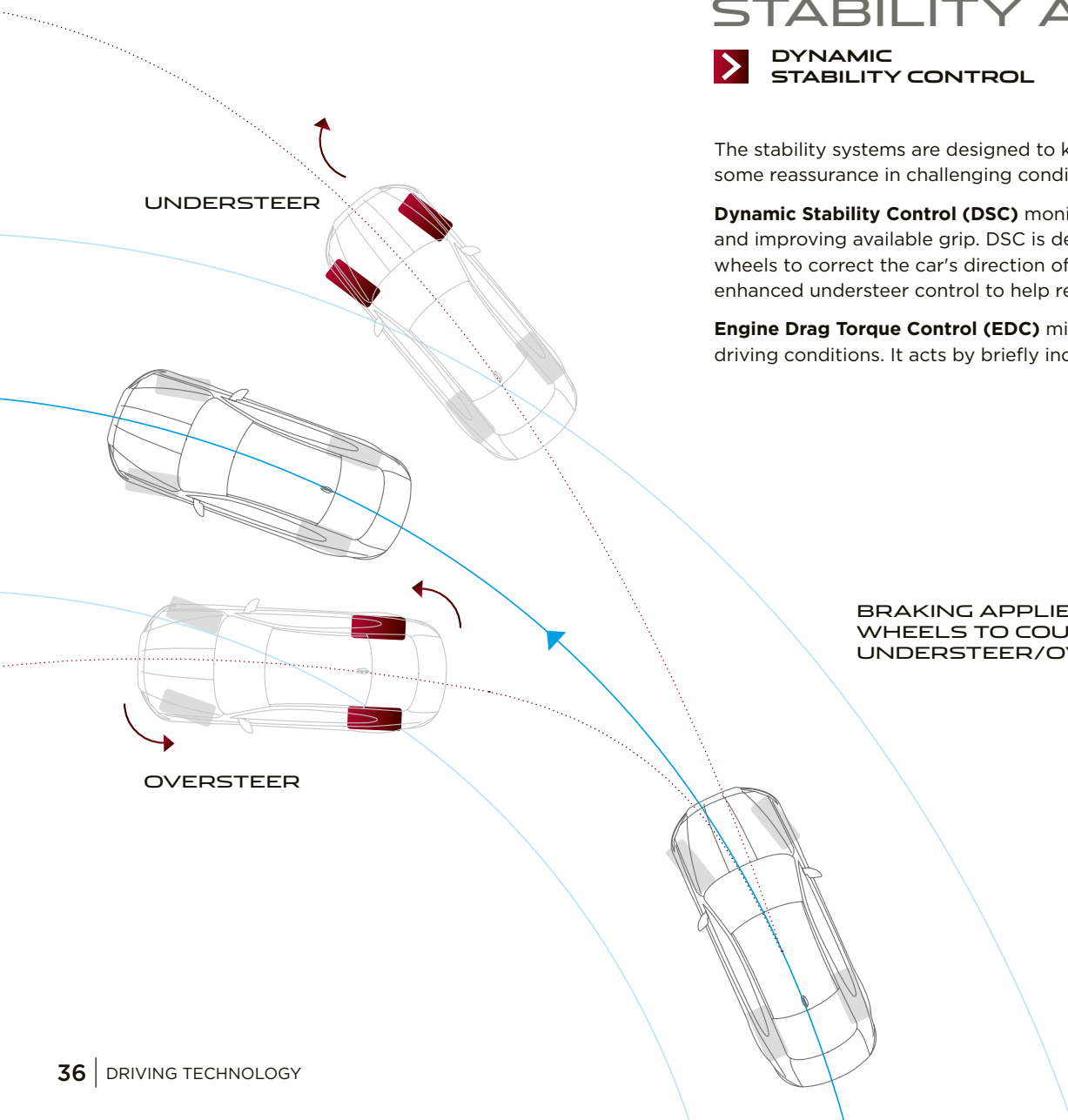

BRAKING APPLIED TO APPROPRIATE
WHEELS TO COUNTERACT
UNDERSTEER/OVERSTEER

*These systems are not a substitute for driving safely with due care and attention and will not function under all circumstances, speeds, weather and road conditions, etc. Driver should not assume that these features will correct errors of judgment in driving. Please consult the owner's manual or your local authorized Jaguar Retailer for more details.

VEHICLE SHOWN: JAGUAR XE S IN FIRENZE RED WITH OPTIONAL EQUIPMENT



EBS 756

JAGUAR

XE



Darkness
Over Duty
Endless
4-12

90 110
70 130
50 150
30 170
10 190

0
mph

3 4 5
2
1
P

HOME 2:56pm

Navigation Arlington Avenue
Leamington Spa
40m 4:55pm

Media Bluetooth audio
Young Before Your Time
Convidas

Phone My iPhone

71 62

sync

MAX MAX A/C A/C

60 200 300

TECHNOLOGY INFOTAINMENT

Delivering a wealth of information and entertainment, every Jaguar XE is equipped with our Jaguar InControl® infotainment system, Touch Pro. It features intuitive and advanced integrated technologies to ensure everyone can make the most of their trip*.



10" TOUCH PRO

The standard 10" Touchscreen at the heart of the center console supports swipe and pinch gestures and delivers our richest ever audio-visual entertainment. To enhance the in-car experience, Touch Pro offers customizable home screens and fast response times as well as voice control. Multi-tasking is also made easy thanks to the Interactive Side Panel. Touch Pro can be further enhanced by adding Navigation Pro.



INTERACTIVE DRIVER DISPLAY¹

The optional 12.3" high-definition Interactive Driver Display can receive and project a vast amount of driving information, entertainment and driver assistance data including navigation, phone and media. Its high resolution ensures the utmost clarity and its refined processing engine delivers smooth moving pin graphics. To help you find your way more easily, Navigation Pro enables you to display fullscreen navigation with 3D mapping**.



HEAD-UP DISPLAY¹

Minimizing distractions and the need to take your eyes off the road, Head-up Display is an option that presents key vehicle data such as vehicle speed, gear position and navigation directions on the windshield. It features crystal clear color graphics in high resolution, enabling you to see all driver inputs and information with ease[†]. It can display important information from Touch Pro and your phone. The feature can be turned on and off dependent on driver preference.

*Do not use Jaguar InControl® features under conditions that will affect your safety or the safety of others. Driving while distracted can result in loss of vehicle control.

**Driving while distracted can result in loss of vehicle control. Do not operate, adjust or view the navigation or multimedia systems under conditions that will affect your safety or the safety of others. Only use mobile phones, and other devices, even with voice commands, when it is safe to do so. [†]These features are not a substitute for driving safely with due care and attention and will not function under all circumstances, speeds, weather and road conditions, etc. Driver should not assume that these features will correct errors of judgment in driving. Please consult the owner's manual or your local authorized Jaguar Retailer for more details.

¹Not available on XE and XE Premium.

Remote contains subscription services that can be extended after the initial term advised by your Jaguar Retailer. InControl features, options and their availability remain market dependent - check with your Jaguar Retailer for local market availability and full terms. Information and images displayed in relation to the InControl technology, including screens or sequences, are subject to software updates, version control and other system/visual changes depending on options selected.

Mobile network connectivity cannot be guaranteed in all locations. InControl Apps and Remote App will need to be downloaded from the Apple/Play Store. All in-car features should be used by drivers only when safe for them to do so. Drivers must ensure they are in full control of the vehicle at all times.

CONNECTIVITY

Jaguar InControl® is our suite of standard and optional features that connects you to your vehicle and links you seamlessly with the outside world. With a selection of apps, even when you're away from your car, some of the InControl features stay with you, making sure the Jaguar experience is more enjoyable than ever*.

STANDARD FEATURES

PINPOINT TOUCH CONTROL*

Pinpoint touch control allows you to interact with information swiftly. The Touchscreen responds in the same manner as a smartphone or tablet computer, providing multitouch gestures such as pinch to zoom and swipe.

PERSONALIZED HOMEPAGE*

You can set up your homescreens the way you want them. With over 60 shortcuts and widgets, you can customize your system around the features you use most.

INTERACTIVE SIDE PANEL*

A choice of side panels means you can multi-task. For example, your main screen area can be used for navigation, while the side panel provides phone controls. Simply swipe up and down to switch between multiple panels.

MULTIMEDIA*

Enjoy a range of multimedia features on the Touchscreen. Connect your device and see details of playlists and music displayed by artist, album and genre. Create a list of songs you want to play and add to the line up at any time.

ENHANCED PHONE INTERFACE*

Making it easier, you can call a favorite contact with a single touch. Additional functionality includes direct access to voicemail, conference calling and homescreen integration.

VOICE RECOGNITION SYSTEM

Understands clear spoken instructions, so you can concentrate on the road ahead with less distraction.

*Do not use Jaguar InControl® features under conditions that will affect your safety or the safety of others. Driving while distracted can result in loss of vehicle control. Remote contains subscription services that can be extended after the initial term advised by your Jaguar Retailer. InControl features, options and their availability may vary – check with your Jaguar Retailer for availability and full terms. Information and images displayed in relation to the InControl technology, including screens or sequences, are subject to software updates, version control and other system/visual changes depending on options selected. Mobile network connectivity cannot be guaranteed in all locations. InControl Apps and Remote App will need to be downloaded from the Apple/Play Store. All in-car features should be used by drivers only when safe for them to do so. Drivers must ensure they are in full control of the vehicle at all times.



PROTECT

Jaguar Optimized Assistance – You can make a direct call to the Jaguar Assistance team by pressing the button on the overhead console or from the Assistance screen within the InControl Remote smartphone app.

SOS Emergency Call – Emergency services will be automatically notified if the airbags are deployed in an accident. For peace of mind, this service is provided for the first ten years from date of registration.

Remote – Remote provides information on your vehicle and enables you to interact with it remotely:

- **Remote Lock/Unlock** – Lock or unlock your doors remotely. Simply press the 'lock' button on the Vehicle Security screen of the Remote smartphone app to single lock the doors and fold in the side mirrors¹. Press the 'unlock' button to open your vehicle, unfold the side mirrors, turn on the dipped headlights and cause the hazard lights to flash twice to help you locate your vehicle.
- **Remote Climate** – Prepare your Jaguar XE in advance by pre-heating or pre-cooling the cabin, so that you and your passengers are comfortable from the moment you step inside.
- **Beep/Flash** – This feature turns on your Jaguar's hazard lights, dipped headlights and sounds an audible alert to help you locate your vehicle.

¹When power fold mirrors are specified.

OPTIONAL FEATURES

NAVIGATION PRO¹

Navigation Pro allows you to save your favorite places, use pinch and zoom gestures for simple map exploration and display a choice of either 2D or 3D crystal clear map graphics. Navigation Pro functionality is further enhanced by the Connect Pro Package*.

CONNECT PRO^{1 2}

Connect Pro consists of InControl Apps, a 4G Wi-Fi Hotspot** and Pro Services. It's designed to enhance your in-car and out-of-car experience, ensuring you and your passengers enjoy the journey while remaining connected to the world.

INCONTROL APPS

Jaguar InControl Apps technology allows vehicle-optimized apps on your Android™ or Apple® smartphone to be controlled through the vehicle's Touchscreen, including contacts, calendar and music player via a USB cable. You can also download third-party apps offering a range of services*.

- **Spotify³** – Access a library of more than 30 million songs with this seamlessly integrated app. Featuring all the same intuitive functionality as the Spotify smartphone app, you can search songs, stations and recommendations, create playlists and access your music in offline mode. Simply log in using your existing Spotify Free or Spotify Premium account.
- **Tile⁴** – Helps you find lost or misplaced items in seconds. Attach a tiny Bluetooth tracker Tile to your keys, wallet or bag. The easy-to-use Tile app can then help you find these items should they be misplaced. The app is accessible any time through your vehicle's Touchscreen, allowing you to make sure you have everything you need with you, before you set off on your journey*

4G WI-FI

The 4G Wi-Fi Hotspot provides in-car access to the Internet, enabling up to eight wireless devices to be used simultaneously in the car. Passengers can connect through the vehicle's wireless network to surf, work, update social media and stay entertained throughout the journey**.

PRO SERVICES

- **Real Time Traffic Information** – Uses live traffic data feeds to give you the most accurate picture of what the traffic is like on the way to your destination*.
- **One-box Search** – Wherever you are, you can search the surrounding area for places of interest. The system can access expert destination information, travel tips and inspiration as well as online travel reviews of the local area*.
- **Planning Routes and Door-to-Door Routing** – Before setting off, use the Route Planner app or online to search, save locations or set your destination. The app uses the Cloud to send your destination automatically to your vehicle's navigation screen. Once you've parked, the Route Planner app will guide you to your destination – a true door-to-door experience which includes public transportation options*
- **Satellite View** – When you want to get the context of your surroundings from overhead, simply switch to satellite view*.

*Do not use Jaguar InControl® features under conditions that will affect your safety or the safety of others. Driving while distracted can result in loss of vehicle control.

**The Wi-Fi Hotspot is intended for passenger use only. InControl features may require an additional subscription with separate terms and conditions.

¹Optional on XE and XE Premium, standard on all other models. ²Connect Pro Package is only available with Navigation Pro. ³Please check App Store and Google Play for availability. ⁴Bluetooth tracker tiles must be purchased separately. ©2016 Tile Inc. and the Tile design are trademarks of Tile, Inc.

- **Share ETA** – You can share your estimated time of arrival so your selected contact(s) will know exactly when you will arrive, as calculated by the navigation guidance system. If you're running late, Share ETA can then send automatic updates via text messages or email, without any further action from you*.
- **Commuter Mode** – Allows the system to learn your commutes and automatically advises you of the expected travel time based on live and historical traffic movements without you having to input a destination. The system learns the routes you take for a given destination and then advises which of those is the quickest. The feature can be turned on and off dependent on driver preference.
- **Parking Service** – As you approach your destination, you can see where parking is available. Simply tap on the parking and the navigation system updates to direct you to it.
- **Online Routing** – While you're on your way to a destination the system monitors live traffic conditions and takes into account typical traffic patterns for that time of day, keeping you on the optimum route.
- **Fuel Prices** – When you're going to fill up, the Fuel Price service not only finds gas stations along your route, it also enables you to compare fuel prices so you can keep your costs down.



Remote contains subscription services that can be extended after the initial term advised by your Jaguar Retailer. InControl features, options and their availability may vary – check with your Jaguar Retailer for availability and full terms. Information and images displayed in relation to the InControl technology, including screens or sequences, are subject to software updates, version control and other system/visual changes depending on options selected. Mobile network connectivity cannot be guaranteed in all locations. InControl Apps and Remote App will need to be downloaded from the Apple/Play Store. All in-car features should be used by drivers only when safe for them to do so. Drivers must ensure they are in full control of the vehicle at all times.

Please ensure iPhone compatibility is reviewed with your local Jaguar Retailer.

AUDIO

A vehicle's cabin is the ideal place within which to experience your personal choice of music and Jaguar XE has the option of three different audio systems to bring your music to life:



SOUND SYSTEM¹

Excellent acoustic range through six speakers.

MERIDIAN™ SOUND SYSTEM²

Great definition, crystal clear highs and full, deep bass – delivered through the careful arrangement of 10 speakers and a dual channel subwoofer.

MERIDIAN SURROUND SOUND SYSTEM³

All the fullness and clarity of a live performance delivered through an arrangement of 16 front, side and rear speakers and a dual channel subwoofer – seamlessly brought together using Trifield™ technology. Exclusive to Meridian, Trifield perfectly blends the center and surround channels with left and right channels ensuring an optimum, consistent sound experience for each passenger.

SIRIUSXM® SATELLITE RADIO*

Optional SiriusXM® Satellite radio technology offers a wide choice of stations and entertainment.

¹Standard on XE, not available on other models. ²Not available on XE and XE Portfolio, standard on other models. ³Standard on Portfolio, optional on other models. Not available on XE and XE Premium.







*A 3-month trial subscription to the SiriusXM All Access package is included with the vehicle, which gives you access to 175+ channels of premium programming. Plus you can stream SiriusXM on your computer, smartphone or tablet – it's included in your trial. If you decide to continue service after your trial, the subscription plan you choose will automatically renew thereafter and you will be charged according to your chosen payment method at then-current rates. Fees and taxes apply. To cancel you must call SiriusXM at 1-866-635-2349. See the SiriusXM Customer Agreement for complete terms at siriusxm.com. All fees and programming are subject to change. SiriusXM Satellite Radio is not available in Alaska, Hawaii, or Puerto Rico.

Please refer to page 62 for feature availability.

Image is representative of Meridian Surround Sound System

MERIDIAN

Formed in 1977 in Cambridgeshire, England, Jaguar's audio partner Meridian has pioneered many firsts including active speakers and the world's first digital surround sound processor. Meridian's audio technology input has helped ensure that the Jaguar XE is one of the most superb spaces. Meridian Cabin Correction technology was utilized to analyze cabin shape, acoustics and resonance characteristics in order to help remove unwanted sounds. The advanced algorithm ensures that the rhythm, punch and timing of any piece of music are heard precisely how the artist intended, providing a consistently exceptional quality audio experience for all passengers in the vehicle.

| | UNIQUE MERIDIAN TECHNOLOGY | SPEAKERS + SUBWOOFERS | WATTS |
|---------------------------------|---|-----------------------|-------|
| SOUND SYSTEM | N/A | 6 | 125 |
| MERIDIAN™ SOUND SYSTEM |    | 10 + 1 | 380 |
| MERIDIAN™ SURROUND SOUND SYSTEM |     | 16 + 1 | 825 |



DIGITAL SIGNAL PROCESSING

Brings all elements of the audio system together as one, for performance that would otherwise require significantly larger speakers.



MERIDIAN CABIN CORRECTION

The advanced algorithm of Meridian's Cabin Correction tailors the sound experience to the precise acoustics of the Jaguar XE interior.



MERIDIAN DIGITAL DITHER SHAPING

To maintain the quality of musical recordings, they are converted into a common digital format. Meridian Digital Dither Shaping ensures that digital signal conversions are made smoothly and seamlessly, preserving the finest details of the audio performance. The result is authentic musical conversion, evoking the emotions of the original recording.



TRIFIELD

Exclusive to Meridian, Trifield blends the center and surround channels seamlessly with left and right channels, delivering a consistent, concert-like experience for all occupants.

Please refer to page 62 for feature availability.

Meridian is a trademark of Meridian Audio Ltd.

Trifield and the "three fields" device is a trademark of Trifield Productions Ltd.

Features and their availability may differ by vehicle specification.

ASSISTANCE AND EFFICIENCY

DRIVER ASSISTANCE

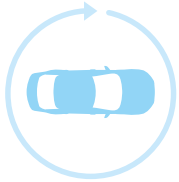

360° SURROUND CAMERA

Helping with various maneuvers, from parking by a curb to getting in and out of tight spaces and intersections, the optional Surround Camera System gives you 360° exterior vision on the Touchscreen. To enhance this system further, new Forward Vehicle Guidance and Forward Traffic Detection are also available. Forming part of the 360° Surround Camera, Forward Vehicle Guidance provides the driver with an onscreen visualisation of the vehicle and parking distance. Forward Traffic Detection helps avoid potential collisions in situations where forward maneuvers involve restricted views*.



REAR CAMERA

Standard Rear Camera provides improved visibility when reversing. This valuable parking aid also helps when hitching a trailer. Static lines representing the vehicle's outer perimeter and predicted path are superimposed on the rearward image, to make parking in tight spots as easy as possible*.

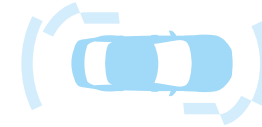

360° PARKING AID

Available 360° Parking Aid uses ultrasonic sensors to the front, rear and sides of the vehicle to alert you to the proximity of objects when parking or exiting from a parking spot*.



EMERGENCY BRAKING

Should a potential collision be detected, if fitted with EB, the XE gives an audible forward collision warning. Visual warnings follow. If the driver takes no action**, the system is designed to apply the brakes to help reduce the severity of the possible impact, when driving below 50 mph. This system also includes pedestrian sensing*.



PARK ASSIST

Optional Park Assist makes parking in tight spaces easier than ever. The XE can accurately steer itself during both parallel and perpendicular parking maneuvers - the driver only has to control the brakes and accelerator. An exit assist function can help guide the XE while leaving a parallel space*.

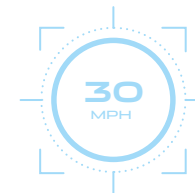

TRAFFIC SIGN RECOGNITION AND ADAPTIVE SPEED LIMITER

Optional Traffic Sign Recognition technology detects speed limits, including variable limits, and no passing signs via the forward-facing camera, then displays them to the driver. The optional Adaptive Speed Limiter uses detected traffic sign information to help keep the XE within the appropriate speed limit*. Where no traffic sign is detected, the Adaptive Speed Limiter can also use the map data from the optional Navigation System.

*These systems are not a substitute for driving safely with due care and attention and will not function under all circumstances, speeds, weather and road conditions, etc. Driver should not assume that these features will correct errors of judgment in driving. Please consult the owner's manual or your local authorized Jaguar Retailer for more details.

** Please note that if any action is taken, even minimal steering, the Emergency Braking system will assume the driver resumed control of the vehicle and the system will automatically disengage.

Please refer to page 59 for fitment requirements.



BLIND SPOT ASSIST

Blind Spot Assist uses radar sensors to detect quickly approaching vehicles and, if necessary, the system can provide assistance in preventing foreseeable collisions. If your vehicle detects another car in your blind spot when you begin to change lanes, a small warning light illuminates in the corresponding side mirror and a steering torque encourages you to guide your vehicle away from the approaching vehicle*.

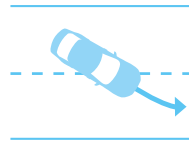

LANE DEPARTURE WARNING

The system senses when your vehicle is unintentionally drifting out of your lane, and notifies you with a visual alert and a gentle vibration of the steering wheel*.



LANE KEEP ASSIST AND DRIVER CONDITION MONITOR

Lane Keep Assist is designed to sense unintentional lane drift and to help steer the Jaguar XE back into its lane. Driver Condition Monitor is designed to detect lapses in concentration due to tiredness by monitoring driver inputs and suggests taking a break via an audible alert and a visual notification in the instrument cluster*.



REAR TRAFFIC MONITOR

Rear Traffic Monitor is particularly useful when reversing out of a parking space, the system is designed to warn you of vehicles, pedestrians or other hazards, approaching from either side of your vehicle. It will alert you with both audio and visual warnings even when the view is obstructed.

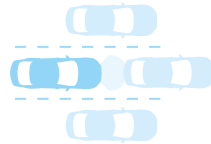

ADAPTIVE CRUISE CONTROL WITH QUEUE ASSIST*

Adaptive Cruise Control uses radar technology to automatically adjust your speed to maintain a set distance from the vehicle ahead. If that vehicle slows, your Jaguar XE reduces its speed to maintain a set distance. The Jaguar XE resumes its pre-set speed as soon as the road in front is clear. Should the car in front stop completely, the Queue Assist function is designed to help bring the Jaguar XE to a smooth halt. Once the traffic moves, touch the accelerator and the Jaguar XE will follow the car in front again*.



EFFICIENT TECHNOLOGIES

SUSTAINABLE CONSTRUCTION

Jaguar Land Rover are committed to producing vehicles that use more sustainable materials, produce less waste and use fewer natural resources as part of our approach to sustainability excellence. The XE development process has included a full life cycle assessment and has been designed to be 85 percent recyclable/re-usable and 95 percent recoverable at the end of the vehicle's life.

Recycled materials have been used in XE wherever possible. Each car contains up to 22 lbs of recycled plastics, which is the equivalent of 769 small plastic water bottles. The use of recycled material in XE means that approximately 6,290 tons of plastic are diverted away from landfill over its entire lifecycle. Parts containing recycled plastics include - the floor console base, wheel arch liners, and intersection box covers.

ENGINE MANUFACTURING CENTER

Jaguar Land Rover's Engine Manufacturing Center, where the XE engines are developed, has been built to the highest environmental standard (BREEAM Excellent) and features the largest rooftop solar panel installation in the UK. Comprising no fewer than 22,600 individual panels, which are capable of providing up to 6.2MW (enough energy to power 1,600 homes). The panels generate more than 30 percent of the site's energy, reducing the plant's CO₂ footprint by over 2,400 tons per year.

ADVANCED AERODYNAMICS

The streamlined shape of the XE navigates air around the rear wheels to reduce bumpiness. The smooth underfloor has been honed through exhaustive testing to perfect airflow efficiency.

Helping XE cut through the air and improve fuel efficiency, lower bumper intakes optimize airflow past the front wheels, by feeding air to the inner wheel arch from ducts in the front spoiler.

To reduce drag, which in turn reduces CO₂ emissions, an aero blade below the rear bumper helps redirect air away from the rear of the car. It also helps clean your rear windshield and lights.

ECO MODE

Eco Mode encourages fuel-efficient driving by reducing throttle sensitivity, selecting more economical engine mapping. It also reduces fuel consumption by minimizing the energy demands placed on the engine by climate control and audio systems. A display on the Touchscreen provides vehicle data and driving tips.

XE LANDMARK EDITION

The XE Landmark Edition's sporty and sleek look includes a unique front bumper, body-colored side sills, a trunk spoiler and unique 18" wheels. Adaptive Xenon headlights with LED signature and Black Package are standard. Exclusive to the Landmark Black Package are Black mirror caps. The car is available in three attractive colors - Yulong White, Firenze Red, Santorini Black. Inside, choose perforated leather in Ebony/Ebony with Light Oyster contrast twin-needle stitching, or Ebony/Pimento with contrast twin-needle stitching in Pimento. Other features include, a Luxtec wrapped instrument panel topper with contrast stitch, a Meshed Aluminum finisher and Ebony Morzine headlining.

To see the complete list of XE Landmark Edition standard features, and the extensive range of options and accessories available, visit jaguarusa.com

VEHICLES SHOWN: JAGUAR XE LANDMARK EDITION IN FIRENZE RED, SANTORINI BLACK AND YULONG WHITE WITH OPTIONAL EQUIPMENT





PERSONALIZATION THE XE - YOUR CHOICE

 Configure your vehicle at jaguarusa.com



CHOOSE YOUR ENGINE

Page 54

Select one of the powerful, gas or diesel engines to suit your driving style.

CHOOSE YOUR MODEL & OPTIONS

Page 56

Compare the wealth of standard features and options on XE models.

CHOOSE YOUR COLOR

Page 64

Express your individuality with one of the stunning exterior colors available on the XE.



CHOOSE YOUR
WHEELS

Page 66

Add the personal finishing touch to your new XE, and complement its stunning style, with a set of beautifully designed alloy wheels.



CHOOSE YOUR
INTERIOR

Page 68

There's a wide selection of premium materials, leathers, veneers and finishes for every personal taste.



CHOOSE YOUR
**JAGUAR GEAR -
ACCESSORIES**

Page 84

Really make it yours by adding style, practicality and versatility with official XE Gear Accessories from your local Jaguar Retailer.

1 CHOOSE YOUR ENGINE

 Configure your vehicle at jaguarusa.com

DIESEL ENGINES

2.0 LITER

4-CYLINDER TURBOCHARGED

MAXIMUM POWER 180HP

MAXIMUM TORQUE 317 lb-ft

ACCELERATION 0-60 mph
RWD 7.6 seconds / AWD 7.8 seconds*

TOP SPEED 120 mph*

XE, PREMIUM, PRESTIGE, R-SPORT



RWD 0-60 MPH



AWD 0-60 MPH



RWD TOP SPEED MPH



AWD TOP SPEED MPH

*Always follow local speed limits.

➤ GAS ENGINES

2.0 LITER

4-CYLINDER TURBOCHARGED

MAXIMUM POWER 247HP

MAXIMUM TORQUE 269 lb-ft

ACCELERATION 0-60 mph
RWD 6.2 seconds / AWD 6.3 seconds*

TOP SPEED 120 mph*

XE, PREMIUM, PRESTIGE, R-SPORT



RWD 0-60 MPH



AWD 0-60 MPH

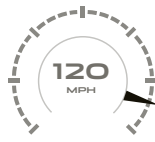

RWD TOP SPEED MPH

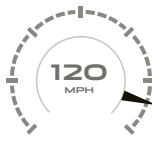

AWD TOP SPEED MPH

2.0 LITER

4-CYLINDER TURBOCHARGED

MAXIMUM POWER 296HP

MAXIMUM TORQUE 295 lb-ft

ACCELERATION 0-60 mph
RWD 5.6 seconds / AWD 5.4 seconds*

TOP SPEED RWD 120 mph / AWD 120 mph*

PREMIUM, PRESTIGE, PORTFOLIO, R-SPORT



RWD 0-60 MPH



AWD 0-60 MPH

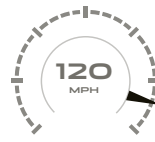

RWD TOP SPEED MPH

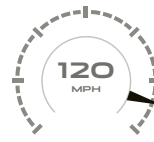

AWD TOP SPEED MPH

3.0 LITER V6

SUPERCHARGED

MAXIMUM POWER 380HP

MAXIMUM TORQUE 332 lb-ft

ACCELERATION 0-60 mph
RWD 4.8 seconds / AWD 4.8 seconds*

TOP SPEED 121 mph*

S



RWD 0-60 MPH



AWD 0-60 MPH

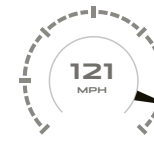

RWD TOP SPEED MPH

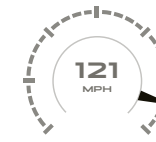

AWD TOP SPEED MPH

2 CHOOSE YOUR MODEL

 Configure your vehicle at jaguarusa.com

> LUXURY



XE

KEY FEATURES

17" alloy wheels
Halogen headlights
Luxtac seats
10-way front seats
Gloss Black finisher
All Surface Progress Control*
Electric tilt and slide glass moonroof
Chrome window surround
Soft grain leather steering wheel
Rear View Camera*
InControl Protect™
InControl Remote™
Metal Treadplates with Jaguar Script



PREMIUM

KEY FEATURES (IN ADDITION TO XE)

17" alloy wheels¹ / 18" alloy wheels²
Meridian™ Sound System
Memory function with 2 settings for driver seat and exterior mirrors
Auto-dimming, power fold, heated door mirrors with memory and approach lights
Garage Door Opener (HomeLink®)
Split-fold rear seat (40:20:40)



PRESTIGE

KEY FEATURES (IN ADDITION TO PREMIUM)

18" alloy wheels¹ / 19" alloy wheels²
Grained leather seats
Front seats 4-way power lumbar
Heated front seats
Dark Satin Brushed Aluminum finishers
Heated soft grain leather sport steering wheel
Keyless Entry
Power steering column with memory
Navigation Pro**
InControl Apps†
Pro Services and Wi-Fi Hotspot
Ambient Interior Lighting

*These features are not a substitute for driving safely with due care and attention and will not function under all circumstances, speeds, weather and road conditions, etc. Driver should not assume that these features will correct errors of judgment in driving. Please consult the owner's manual or your local Jaguar Retailer for more details. **Driving while distracted can result in loss of vehicle control. Do not operate, adjust or view the navigation or multimedia systems under conditions that will affect your safety or the safety of others. Only use mobile phones, and other devices, even with voice commands, when it is safe to do so. †Do not use Jaguar InControl® features under conditions that will affect your safety or the safety of others. Driving while distracted can result in loss of vehicle control. **Please note that if any action is taken, even minimal steering, the Emergency Braking system will assume the driver resumed control of the vehicle and the system will automatically disengage.

¹Available on 20d and 25t derivatives only. ²Available on 30t derivative only. ³Only available with 30t engine.

Images feature optional equipment. Please note that standard features may be replaced when selecting alternative trim levels. Standard features may also vary depending on engine variant and transmission, please refer to Specification Guide or jaguarusa.com

> SPORT



PORTFOLIO³

KEY FEATURES (IN ADDITION TO PRESTIGE)

- 14-way perforated Windsor leather seats
- Heated and cooled front seats with heated rear seats
- Gloss Figured Ebony veneer
- 12.3" Interactive Driver Display
- Meridian™ Surround Sound System
- Configurable Ambient Interior Lighting
- Head-up Display*
- Emergency Braking⁺⁺
- Blind Spot Monitor and Reverse Traffic Detection*
- Lane Keep Assist and Driver Condition Monitor*
- Front and Rear Parking Aid*
- Adaptive Xenon headlights with LED signature
- Auto High Beam Assist (AHBA)*
- Powered Gesture Trunk lid



R-SPORT

KEY FEATURES (IN ADDITION TO PRESTIGE)

- Perforated grained leather sports seats with contrast stitching
- R-Sport branded soft grain leather steering wheel
- Black radiator grille with Satin Chrome surround
- Etched Aluminum trim finishers
- Gloss Black window surround
- R-Sport bodykit - R-Sport front bumper, Body-colored extended side sills, Satin Chrome side power vents with R-Sport badge and trunk lid spoiler
- R-Sport branding on Metal Treadplates
- Adaptive Xenon headlights with LED signature
- Auto High Beam Assist (AHBA)*
- Lane Departure Warning, Lane Keep Assist, Driver Condition Monitor*
- Blind Spot Monitor and Reverse Traffic Detection*
- Front and Rear Parking Aids*
- Emergency Braking⁺⁺



S

KEY FEATURES (IN ADDITION TO R-SPORT)

- 19" 15 spoke 'Style 1015' with Gloss Black Diamond Turned finish alloy wheels
- S branded grained leather and suedecloth sports seats
- S branded soft grain leather steering wheel
- Black radiator grille with Satin Chrome surround
- Meshed Aluminum trim finishers
- S bodykit - S front bumper, S body-colored and Gloss Black extended side sills, S Gloss Black rear valance and trunk lid spoiler
- Red brake calipers
- S branding on Metal Treadplates
- Adaptive Dynamics*

2 CHOOSE YOUR OPTIONS

 Configure your vehicle at jaguarusa.com

| KEY STANDARD & OPTIONAL FEATURES | XE | PREMIUM | PRESTIGE | PORTFOLIO | R-SPORT | S |
|---|----|---------|----------|-----------|---------|---|
| TRANSMISSION, STEERING & DYNAMIC FEATURES | | | | | | |
| 8-speed Automatic Transmission | ● | ● | ● | ● | ● | ● |
| Power-assisted, speed sensitive, variable ratio, rack and pinion steering | ● | ● | ● | ● | ● | ● |
| Electric Power-Assisted Steering (EPAS)* | ● | ● | ● | ● | ● | ● |
| Torque Vectoring by Braking (TVBB)* | ● | ● | ● | ● | ● | ● |
| Hill Launch Assist* | ● | ● | ● | ● | ● | ● |
| All Surface Progress Control (ASPC)* | ● | ● | ● | ● | ● | ● |
| Steering wheel mounted shift paddles | ● | ● | ● | ● | ● | ● |
| JaguarDrive Control™ | ● | ● | ● | ● | ● | ● |
| Normal, Eco & Dynamic Modes* | ● | ● | ● | ● | ● | ● |
| Rain/Ice/Snow Mode* | ● | ● | ● | ● | ● | ● |
| JaguarDrive Selector™ rotary gear selector | ● | ● | ● | ● | ● | ● |
| Adaptive Surface Response (AdSR) (AWD only) | — | — | — | — | — | ● |
| SUSPENSION | | | | | | |
| Four-wheel independent suspension | ● | ● | ● | ● | ● | ● |
| Double wishbone front suspension architecture | ● | ● | ● | ● | ● | ● |
| Integral Link rear suspension | ● | ● | ● | ● | ● | ● |
| Adaptive Dynamics* | — | — | ○ | ○ | ○ | ● |
| BRAKES & STABILITY CONTROL | | | | | | |
| Anti-lock Braking System (ABS) | ● | ● | ● | ● | ● | ● |
| Brake pad wear indicator | ● | ● | ● | ● | ● | ● |
| Cornering Brake Control (CBC)* | ● | ● | ● | ● | ● | ● |
| Dynamic Stability Control (DSC) with TracDSC mode* | ● | ● | ● | ● | ● | ● |
| Electric Parking Brake (EPB) with drive away release* | ● | ● | ● | ● | ● | ● |
| Alloy space saver spare wheel | ● | ● | ● | ● | ● | ● |
| Red brake calipers | — | — | — | — | — | ● |

SAFETY & SECURITY

| SAFETY & SECURITY | XE | PREMIUM | PRESTIGE | PORTFOLIO | R-SPORT | S |
|--|----|---------|----------|-----------|---------|---|
| SAFETY | | | | | | |
| Passive front head restraints (whiplash reduction system) | ● | ● | ● | ● | ● | ● |
| Belt-minder system with audio reminder chime and flashing warning light engages if vehicle is moving more than 10 mph and safety belt is not buckled on occupied front or rear seats | ● | ● | ● | ● | ● | ● |
| Driver and front passenger safety belt pretensioners | ● | ● | ● | ● | ● | ● |
| ISOFIX child seat tethered-anchorage | ● | ● | ● | ● | ● | ● |
| Dual-stage front airbags and seat-mounted side airbags** for front occupants | ● | ● | ● | ● | ● | ● |
| Full length side-impact curtain airbags for front and rear** | ● | ● | ● | ● | ● | ● |
| Three-point restraints at all seating positions | ● | ● | ● | ● | ● | ● |
| Tire Pressure Monitoring System (TPMS) | ● | ● | ● | ● | ● | ● |
| SECURITY | | | | | | |
| Anti-theft engine immobilizer | ● | ● | ● | ● | ● | ● |
| Drive away locking | ● | ● | ● | ● | ● | ● |
| Security system with perimeter alarm | ● | ● | ● | ● | ● | ● |
| Emergency phosphorescent release in trunk | ● | ● | ● | ● | ● | ● |
| LOCKING | | | | | | |
| 2-stage unlock (programmable) | ● | ● | ● | ● | ● | ● |
| Central locking with drive-away door locking (programmable) | ● | ● | ● | ● | ● | ● |
| Jaguar Smart Key System™ with emergency key – provide remote locking/unlocking, access to trunk and activate panic alarm | ● | ● | ● | ● | ● | ● |
| Keyless Entry | — | ○ | ● | ● | ● | ● |
| Power operated child locks | ● | ● | ● | ● | ● | ● |
| Valet function for Touchscreen and trunk security | ● | ● | ● | ● | ● | ● |

● Standard ○ Option — Not available ■ Option as part of Package

P1 Cold Climate Package P2 Vision Assist Package P3 Comfort & Convenience Package P4 Driver Assistance Package P5 Black Design Package P6 Technology Package

*These features are not a substitute for driving safely with due care and attention and will not function under all circumstances, speeds, weather and road conditions, etc. Driver should not assume that these features will correct errors of judgment in driving. Please consult the owner's manual or your local Jaguar Retailer for more details. **Please remember that the safety belts in a vehicle constitute the primary protection system for driver and passengers in collisions. Airbags are not designed to deploy in all collisions. The airbag Supplemental Restraint System (SRS) is a supplement to the safety belts and is designed to work as a system with the safety belts. Although airbags provide additional protection, airbags without safety belts do not provide optimal protection in a crash. Always wear your safety belts. Children younger than 13 years old should always be properly restrained in a back seat, away from airbags. Never place an infant seat in the front seat.

DRIVERS AIDS*

| | XE | PREMIUM | PRESTIGE | PORTFOLIO | R-SPORT | S |
|---|----|---------|----------|-----------|---------|----|
| Cruise control | ● | ● | ● | ● | ● | ● |
| Adaptive Speed Limiter (ASL) | ● | ● | ● | ● | ● | ● |
| Blind Spot Monitor with Closing Vehicle Sensing and Reverse Traffic Detection | — | P2 | P2 | ● | ● | ● |
| Blind Spot Assist with Closing Vehicle Sensing and Reverse Traffic Detection | — | — | — | P4 | P4 | P4 |
| Rear View Camera with guidance lines on display | ● | ● | ● | ● | ● | ● |
| Rear Parking Aid sensors with Touchscreen visual indicators | — | P2 | P2 | ● | ● | ● |
| Front Parking Aid sensors with Touchscreen visual indicators | — | P2 | P2 | ● | ● | ● |
| 360° Surround Camera - 4 cameras for front, side and rear views with images shown on the Touchscreen | — | — | — | P4 | P4 | P4 |
| Park Assist - Parallel & Perpendicular Parking plus Parking Exit | — | — | — | P4 | P4 | P4 |
| 360° Parking Aid - additional sensors to alert the driver to potential side impacts | — | — | — | P4 | P4 | P4 |
| Traffic Sign Recognition and Adaptive Speed Limiter (ASL) | — | — | — | P4 | P4 | P4 |
| Adaptive Cruise Control (ACC) with Forward Alert, Queue Assist, Intelligent Emergency Braking and Follow Mode | — | — | — | P4 | P4 | P4 |
| Emergency Braking (uses forward facing camera) | — | P2 | P2 | ● | ● | ● |
| Lane Departure Warning | — | P2 | P2 | — | — | — |
| Lane Keep Assist and Driver Condition Monitor | — | — | — | ● | ● | ● |
| Head-up Display | — | — | ○ | ● | ○ | ○ |

CONVENIENCE FEATURES

| | XE | PREMIUM | PRESTIGE | PORTFOLIO | R-SPORT | S |
|---|----|---------|----------|-----------|---------|----|
| Approach illumination | ● | ● | ● | ● | ● | ● |
| Dual function trip computer in Driver Message Center | ● | ● | ● | ● | ● | ● |
| Outside temperature gauge | ● | ● | ● | ● | ● | ● |
| Lockable glovebox | ● | ● | ● | ● | ● | ● |
| HomeLink® System - compatible three-channel garage-door/entry-gate opener | — | ● | ● | ● | ● | ● |
| Keyless Push Button Start | ● | ● | ● | ● | ● | ● |
| Rain sensing, variable intermittent dual wipers | ● | ● | ● | ● | ● | ● |
| Shopping bag hook in trunk | ● | ● | ● | ● | ● | ● |
| Powered Gesture Trunk lid (requires Keyless Entry and Rear Parking Aid) | — | — | P3 | ● | P3 | P3 |
| Sunglasses holder in overhead console | ● | ● | ● | ● | ● | ● |
| Twin front cupholders plus auxiliary power socket in center console | ● | ● | ● | ● | ● | ● |
| Twin rear cupholders | ● | ● | ● | ● | ● | ● |
| 12V power sockets - located in rear and in trunk | ● | ● | ● | ● | ● | ● |

2 CHOOSE YOUR OPTIONS

 Configure your vehicle at jaguarusa.com

| EXTERIOR FEATURES | | XE | PREMIUM | PRESTIGE | PORTFOLIO | R-SPORT | S |
|--|--|----|---------|----------|-----------|---------|----|
| BODY EXTERIOR APPEARANCE | | | | | | | |
| Bumpers - Body-colored | | ● | ● | ● | ● | ● | ● |
| Exhaust tips | | ● | ● | ● | ● | ● | ● |
| Front Grille | Grained Black mesh insert with Chrome surround | ● | ● | ● | ● | — | — |
| | Grained Black mesh insert with Satin Chrome surround | — | — | — | — | ● | ● |
| | Gloss Black mesh insert with Satin Chrome surround | — | — | — | — | ○ | ○ |
| | Gloss Black mesh insert with Chrome surround | — | — | — | ○ | — | — |
| | Gloss Black mesh insert with Gloss Black surround | — | — | P5 | — | P5 | P5 |
| Window Surround Finishers | Bright Chrome | ● | ● | ● | ● | — | — |
| | Gloss Black | — | — | P5 | — | ● | ● |
| Side Power Vents | Bright Chrome | ● | ● | ● | ● | — | — |
| | Gloss Black | — | — | P5 | P5 | P5 | P5 |
| | "R-Sport" Badge | — | — | — | — | ● | — |
| Front Bumper | Satin Chrome | — | — | — | — | — | ● |
| | "R-Sport" Style bumper | — | — | — | — | ● | — |
| | "S" Style bumper | — | — | — | — | — | ● |
| Side Sills | Gloss Black front bumper blades | — | — | — | — | P5 | — |
| | Body-colored | — | — | — | — | ● | — |
| Rear Valance | Gloss Black | — | — | — | — | — | ● |
| | Gloss Black | ● | ● | ● | ● | ● | — |
| Rear Spoiler - Body-colored, trunk mounted | | — | — | — | — | ● | ● |

| EXTERIOR BADGING | | XE | PREMIUM | PRESTIGE | PORTFOLIO | R-SPORT | S |
|--|--------------------------------|----|---------|----------|-----------|---------|----|
| Trunk Left Side - Nameplate | | ● | ● | ● | ● | ● | ● |
| Center Trunk Lid - Jaguar and leaper wordmark | | ● | ● | ● | ● | ● | ● |
| Trunk Right Side | Powertrain | ● | ● | ● | ● | ● | — |
| | "AWD" with AWD models only | ● | — | ● | ● | — | ● |
| | "S" | — | — | — | — | — | ● |
| Side Power Vents | Chrome | ● | ● | ● | ● | — | — |
| | Satin Chrome with "R-Sport" | — | — | — | — | ● | — |
| | Satin Chrome | — | — | — | — | — | ● |
| | Side Power Vents - Gloss Black | — | — | P5 | — | P5 | P5 |
| ELECTRIC GLASS MOONROOF | | | | | | | |
| Electric with tilt/slide one touch operation and electric blind | | ● | ● | ● | ● | ● | ● |
| LIGHTS | | | | | | | |
| Halogen headlights | | ● | ● | ● | — | — | — |
| Adaptive Xenon headlights* with variable light distribution including turning lights and auto-leveling | | — | P2 | P2 | ● | ● | ● |
| LED signature "J" blade Daytime Running Lights | | — | P2 | P2 | ● | ● | ● |
| Headlight power wash | | — | P2 | P2 | ● | ● | ● |
| Auto High Beam Assist (AHBA)* | | — | P2 | P2 | ● | ● | ● |
| Partial LED tail lights | | ● | ● | ● | ● | ● | ● |
| MIRRORS & WINDOWS | | | | | | | |
| Exterior mirrors - body-colored, electrically adjustable, heated with clear side turn indicators | | ● | — | — | — | — | — |
| Exterior mirrors - body-colored, powerfolding, electrically adjustable, heated, auto-dimming with memory, approach lights and clear side turn indicators | | — | ● | ● | ● | ● | ● |
| Passenger side exterior mirror - dip in reverse | | — | ● | ● | ● | ● | ● |

● Standard ○ Option — Not available ■ Option as part of Package

P1 Cold Climate Package P2 Vision Assist Package P3 Comfort & Convenience Package P4 Driver Assistance Package P5 Black Design Package P6 Technology Package

*These features are not a substitute for driving safely with due care and attention and will not function under all circumstances, speeds, weather and road conditions, etc. Driver should not assume that these features will correct errors of judgment in driving. Please consult the owner's manual or your local Jaguar Retailer for more details.

INTERIOR FEATURES

| | XE | PREMIUM | PRESTIGE | PORTFOLIO | R-SPORT | S |
|---|----|---------|----------|-----------|---------|---|
| CLIMATE CONTROL | | | | | | |
| Automatic air conditioning with solar sensing, mist sensing, air filtration and dual temperature control for driver and front passenger | ● | ● | ● | ● | ● | ● |
| DOOR SILL FINISHERS | | | | | | |
| Metal with Jaguar script | ● | ● | ● | — | — | — |
| Illuminated metal treadplates with Jaguar script | — | — | — | ● | — | ○ |
| Metal with "R-Sport" script | — | — | — | — | ● | — |
| Metal with "S" script | — | — | — | — | — | ● |
| FOOTWELL RUGS | | | | | | |
| Premium carpet mats | ● | ● | ● | ● | ● | ● |
| Bright metal pedals | ● | ● | ● | ● | ● | ● |
| GEAR SELECTOR | | | | | | |
| JaguarDrive™ rotary gear selector - Bright Chrome finish | ● | ● | ● | ● | ● | ● |
| INTERIOR LIGHTING | | | | | | |
| Overhead light console with JaguarSense™ control | ● | ● | ● | ● | ● | ● |
| Interior Lighting - Switchgear & ICP lighting, front map lights, trunk illumination and front and rear downlighters | ● | ● | — | — | — | — |
| Driver and front passenger sunvisors with illuminated vanity mirrors | — | — | ● | ● | ● | ● |
| Ambient Lighting - Blue halo illumination on front and rear door signature lines and front and rear door release | — | — | ● | — | ● | ● |
| Configurable Ambient Interior Lighting | — | — | — | ● | — | — |
| Glovebox illumination | — | — | ● | ● | ● | ● |
| Front footwell and rear map lights | — | — | ● | ● | ● | ● |
| MIRRORS & WINDOWS | | | | | | |
| Auto-dimming interior rear view mirror | ● | ● | ● | ● | ● | ● |
| Front and rear electric windows with one-touch open/close and anti-trap | ● | ● | ● | ● | ● | ● |
| Infrared reflective front windshield glass | ● | ● | ● | ● | ● | ● |
| Heated rear window | ● | ● | ● | ● | ● | ● |
| Heated front windshield - heated with timer. Includes heated washer jets | ○ | ○ | ○ | ○ | ○ | ○ |

WINDOW SUNBLINDS

| | XE | PREMIUM | PRESTIGE | PORTFOLIO | R-SPORT | S |
|-------------------------------|----|---------|----------|-----------|---------|----|
| Electric rear window sunblind | — | — | P3 | ● | P3 | P3 |

SEATING

| | XE | PREMIUM | PRESTIGE | PORTFOLIO | R-SPORT | S |
|---|----|---------|----------|-----------|---------|----|
| 10x10 way Front seats with 8x8 electric movement - Fore/Aft (2), Cushion Height (2) & Tilt (2), Squab Recline (2) - plus manual Headrest Height (2) | ● | ● | ● | — | ● | — |
| Front seats 4-way power lumbar | — | — | ● | ● | ● | ● |
| 14x14 way front seats with 12x12 electric movement - Fore/Aft (2), Cushion Height (2), Cushion Tilt (2), Cushion Extension (2), Squab Recline (2), Bolster (2) & manual Headrest Height (2) | — | — | — | ● | — | ● |
| Sport-style front seats | — | — | — | — | ● | ● |
| 3-stage heated front seats | P1 | P1 | ● | — | ● | ● |
| 3-stage active ventilated heated and cooled front seats | — | — | P3 | ● | P3 | P3 |
| Driver memory | — | ● | ● | ● | ● | ● |
| Fixed rear seat | ● | — | — | — | — | — |
| 40:20:40 split fold rear seat | — | ● | ● | ● | ● | ● |
| Rear armrest with cupholders | ● | ● | ● | ● | ● | ● |
| 3 rear headrests | ● | ● | ● | ● | ● | ● |

STEERING WHEEL & CONTROLS

| | XE | PREMIUM | PRESTIGE | PORTFOLIO | R-SPORT | S |
|--|----|---------|----------|-----------|---------|---|
| Soft grain leather steering wheel with Jaguar Sequential Shift™ paddles and remote controls for audio, cruise control & Bluetooth® wireless technology | ● | ● | — | — | — | — |
| Soft grain leather sport steering wheel with Jaguar Sequential Shift™ paddles and remote controls for audio, cruise control, Bluetooth® wireless technology and JaguarVoice™ | — | — | ● | ● | ● | ● |
| Heated steering wheel | P1 | P1 | ● | ● | ● | ● |
| "R-Sport" script on steering wheel | — | — | — | — | ● | — |
| "S" script on steering wheel | — | — | — | — | — | ● |
| Power adjustable steering column (reach and rake) with memory | — | — | ● | ● | ● | ● |
| Three flash lane change/turn indicator | ● | ● | ● | ● | ● | ● |

2 CHOOSE YOUR OPTIONS

 Configure your vehicle at jaguarusa.com

INTERIOR FEATURES CONTINUED

| | XE | PREMIUM | PRESTIGE | PORTFOLIO | R-SPORT | S |
|--|----|---------|----------|-----------|---------|---|
| INTERIOR TRIM | | | | | | |
| Front center console with storage compartment, auxiliary power socket, 3.5mm stereo auxiliary input socket and armrest | ● | ● | ● | ● | ● | ● |
| Luxtec seats | ● | ● | — | — | — | — |
| Grained leather seats | — | — | ● | — | — | — |
| Perforated grained leather seats | — | — | ○ | — | ● | ○ |
| Perforated Windsor leather seats | — | — | — | ● | — | — |
| Grained leather and suedecloth seats | — | — | — | — | — | ● |
| Luxtec-wrapped instrument panel | — | — | — | ● | ● | ● |
| Seat back map pocket - Net | — | — | ● | ● | ● | ● |
| Morzine headliner - Light Oyster | ● | ● | ● | ● | — | ○ |
| Morzine headliner - Ebony | — | — | — | ○ | ● | ● |
| VENEER TRIM | | | | | | |
| Gloss Black | ● | ● | — | — | — | — |
| Dark Satin Brushed Aluminum | — | — | ● | — | — | — |
| Etched Aluminum | — | — | — | — | ● | — |
| Satin Burl Ash | — | — | — | — | ○ | ○ |
| Gloss Figured Ebony | — | — | ○ | ● | — | — |
| Carbon Fiber | — | — | — | — | ○ | ○ |
| Meshed Aluminum | — | — | — | — | — | ● |

INFORMATION, COMMUNICATION AND ENTERTAINMENT

| | XE | PREMIUM | PRESTIGE | PORTFOLIO | R-SPORT | S |
|--|----|---------|----------|-----------|---------|----|
| MULTIMEDIA | | | | | | |
| Physical dials with 5" full color TFT LCD display | ● | ● | ● | — | ● | ● |
| Full TFT / LCD Instrument Cluster | — | — | P6 | ● | P6 | P6 |
| InControl Touch Pro™ 10" capacitive Touchscreen display with controls for audio, climate control, Bluetooth, telephone connectivity and navigation* | ● | ● | ● | ● | ● | ● |
| ECO HMI - Includes Eco data analysis, parasitic load monitor and Driver Eco | ● | ● | ● | ● | ● | ● |
| Sound System with 6 speakers | ● | — | — | — | — | — |
| Meridian™ Sound System with 11 speakers incl 1 subwoofer | — | ● | ● | — | ● | ● |
| Meridian™ 7.1 Channel Digital Surround Sound System plus Meridian Trifield mode, 17 speakers including 1 subwoofer, separate DSP, Audyssey MultEQ and Meridian Cabin Correction | — | — | P6 | ● | P6 | P6 |
| Dynamic Volume Control | ● | ● | ● | ● | ● | ● |
| HD Radio™ | ● | ● | ● | ● | ● | ● |
| Front media interface (USB & iPod®) | ● | ● | ● | ● | ● | ● |
| SiriusXM® Satellite Radio** | ○ | ○ | ○ | ● | ● | ● |
| InControl Apps™ enables use of optimized third party smartphone apps installed on a phone through the vehicle's Touchscreen* | P7 | P7 | ● | ● | ● | ● |
| Bluetooth® wireless technology for cell phone and audio streaming† | ● | ● | ● | ● | ● | ● |
| NAVIGATION | | | | | | |
| InControl Touch Pro™ - Navigation System with 60GB Solid State Disk (SSD) Drive-based mapping*. Includes Pro Services, HDD-based virtual multichanger and single slot in dash CD/DVD player (Requires P7) | ○ | ○ | ● | ● | ● | ● |
| TELEMATICS | | | | | | |
| InControl Protect™ - SOS Emergency Call, Jaguar Assistance Call and Stolen Vehicle Locator. Service complimentary for 5 years | ● | ● | ● | ● | ● | ● |
| InControl Remote™ - Smartphone app for vehicle status (fuel level, security status, last parked, direction to vehicle), vehicle lock/unlock, air conditioning remote setting through engine start. Feature complimentary for 5 years | ● | ● | ● | ● | ● | ● |
| InControl Pro Services and Wi-Fi Hotspot - 4G Hotspot - includes 3GB or 3 months (whichever comes first) complimentary data subscription†† | P7 | P7 | ● | ● | ● | ● |

● Standard ○ Optional — Not available NCO No Cost Option

P1 Cold Climate Package P2 Vision Assist Package P3 Comfort & Convenience Package P4 Driver Assistance Package P5 Black Design Package P6 Technology Package P7 Connect Pro Package (Requires Navigation Pro)

*Do not use Jaguar InControl® features under conditions that will affect your safety or the safety of others. Driving while distracted can result in loss of vehicle control. **A 3-month trial subscription to the SiriusXM® All Access package is included with the vehicle, which gives you access to 175+ channels of premium programming. Plus you can stream SiriusXM® on your computer, smartphone or tablet - it's included in your trial. If you decide to continue service after your trial, the subscription plan you choose will automatically renew thereafter and you will be charged according to your chosen payment method at then-current rates. Fees and taxes apply. To cancel you must call SiriusXM® at 1-866-635-2349. See the SiriusXM® Customer Agreement for complete terms at siriusxm.com. All fees and programming are subject to change. SiriusXM® Satellite Radio is not available in Alaska, Hawaii, or Puerto Rico. †Driving while distracted can result in loss of vehicle control. Do not operate, adjust or view the navigation or multimedia systems under conditions that will affect your safety or the safety of others. Only use mobile phones, and other devices, even with voice commands, when it is safe to do so. ††The Wi-Fi Hotspot is intended for passenger use only. InControl® features may require an additional subscription with separate terms and conditions.

OPTION PACKAGES

| | CODE | XE | PREMIUM | PRESTIGE | PORTFOLIO | R-SPORT | S | DESCRIPTION |
|------------------------------------|-------|----|---------|----------|-----------|---------|---|---|
| Cold Climate Package (P1) | 017CA | ○ | ○ | — | — | — | — | Heated front seats, heated steering wheel, heated front windshield, heated washer jets |
| Vision Assist Package† (P2) | 017EK | — | ○ | ○ | — | — | — | Adaptive Xenon headlights with LED signature and Auto High Beam Assist (AHBA), Headlight power wash, Blind Spot Monitor with Closing Vehicle Sensing, Reverse Traffic Detection, Front and Rear Parking Aids, Lane Departure Warning (LDW), Emergency Braking |
| Comfort & Convenience Package (P3) | 017EO | — | — | ○ | — | ○ | ○ | Cooled front seats, heated rear seats, electric rear window sunblind, Powered Gesture Trunk lid |
| Driver Assistance Package† (P4) | 017DS | — | — | — | ○ | ○ | ○ | Adaptive Cruise Control (ACC) with Forward Alert, Queue Assist, Intelligent Emergency Braking and Follow Mode, Blind Spot Assist with Reverse Traffic Detection, 360° Surround Camera, 360° Parking Aid, Traffic Sign Recognition and Adaptive Speed Limiter, Park Assist – Parallel, Perpendicular, & Parallel Exit. |
| Black Design Package (P5) | 032EI | — | — | ○ | — | ○ | ○ | Radiator grille – Gloss Black insert with Gloss Black surround, Gloss Black side power vents, Gloss Black blades in R-Sport front bumper (R-Sport only), Gloss Black window surround (Prestige only) |
| Technology Package (P6) | 074PW | — | — | ○ | — | ○ | ○ | Meridian™ 825W Surround Sound System, 12.3" Full Digital Interactive Driver Display and Single slot in-dash CD/DVD player |
| Connect Pro Package (P7)‡ | 011CF | ○ | ○ | — | — | — | — | InControl Apps™ enables use of optimized third party smartphone apps installed on a phone through the vehicle's Touchscreen* and InControl Pro Services and Wi-Fi Hotspot – 4G Hotspot – includes 3GB or 3 months (whichever comes first) complimentary data subscription†† |

STAND ALONE OPTIONS

| | | | | | | | | |
|--|---------------|-----|-----|-----|-----|-----|---|------------------|
| Heated front windshield with heated washer jets | 040AK & 040AQ | ○ | ○ | ○ | ○ | ○ | ○ | — |
| Head-up Display‡‡ | 039IB | — | — | ○ | ● | ○ | ○ | Refer to page 39 |
| SiriusXM® Satellite Radio** (includes 3 month complimentary service) | 025LA | ○ | ○ | ○ | ● | ● | ● | — |
| Adaptive Dynamics with Configurable Dynamics‡‡ | 027CW | — | — | ○ | ○ | ○ | ● | Refer to page 29 |
| Powertrain debadging | 057EV | NCO | NCO | NCO | NCO | NCO | — | — |
| Illuminated Metal Treadplates with 'Jaguar' script | 048BD | — | — | — | ● | — | ○ | — |

†These features are not a substitute for driving safely with due care and attention and will not function under all circumstances, speeds, weather and road conditions, etc. Driver should not assume that these features will correct errors of judgment in driving. Please consult the owner's manual or your local Jaguar Retailer for more details.

‡‡Requires Navigation Pro.

3 CHOOSE YOUR COLOR

 Configure your vehicle at jaguarusa.com

SOLID

Fuji White

Narvik Black

Caldera Red

METALLIC

Yulong White

Santorini Black

Indus Silver

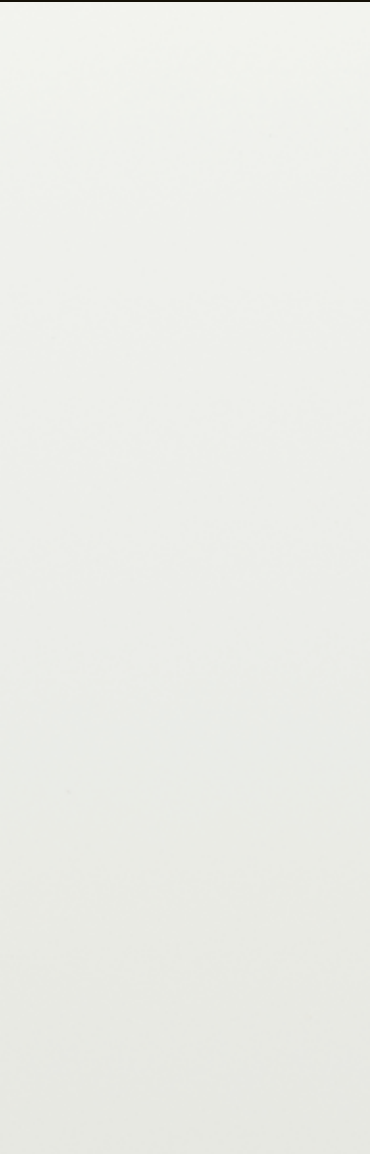

PREMIUM PALETTE

Corris Grey

Caesium Blue

Loire Blue

Firenze Red

Silicon Silver

Carpathian Grey



4 CHOOSE YOUR WHEELS

 Configure your vehicle at jaguarusa.com



17" 10 SPOKE
'STYLE 1047'

Sparkle Finish
7.0J x 17"
205/55 R17 | 225/50 R17
029UU



17" 7 SPLIT-SPOKE
'STYLE 7010'

Sparkle Finish
7.0J x 17"
205/55 R17 | 225/50 R17
029UV



18" 6 SPOKE
'STYLE 6006'

Sparkle Finish
7.5J x 18"
225/45 R18
029UK

| ALLOY WHEEL FINISH | Sparkle Finish | Sparkle Finish | Sparkle Finish |
|--------------------|-------------------------|-------------------------|---------------------------------|
| ALLOY WHEEL/SIZE | 7.0J x 17" | 7.0J x 17" | 7.5J x 18" |
| TIRE SIZE | 205/55 R17 225/50 R17 | 205/55 R17 225/50 R17 | 225/45 R18 |
| CODE | 029UU | 029UV | 029UK |
| XE | ● | — | — |
| Premium | — | ● (20d & 25t only) | ● (30t only)/○ (20d & 25t only) |
| Prestige | — | — | — |
| Portfolio | — | — | — |
| R-Sport | — | — | — |
| S | — | — | — |



18" 7 SPLIT-SPOKE
'STYLE 7009'

Sparkle Finish
7.5J x 18"
225/45 R18
029UL



18" 7 SPLIT-SPOKE
'STYLE 7009'

Black
7.5J x 18"
225/45 R18
029UN



18" 5 SPLIT-SPOKE
'STYLE 5029'

Silver/Diamond Turned
7.5J x 18" | 8.5J x 18"
225/45 R18 | 245/40 R18
029UH

| ALLOY WHEEL FINISH | Sparkle Finish | Black | Silver/Diamond Turned |
|--------------------|--------------------|--------------------|-------------------------|
| ALLOY WHEEL/SIZE | 7.5J x 18" | 7.5J x 18" | 7.5J x 18" 8.5J x 18" |
| TIRE SIZE | 225/45 R18 | 225/45 R18 | 225/45 R18 245/40 R18 |
| CODE | 029UL | 029UN | 029UH |
| XE | ○ | — | — |
| Premium | ○ | — | — |
| Prestige | ● (20d & 25t only) | ○ (20d & 25t only) | — |
| Portfolio | — | — | — |
| R-Sport | — | — | ● (20d & 25t only) |
| S | — | — | — |

● Standard ○ Option — Not Applicable



19" 5 SPLIT-SPOKE
'STYLE 5071'

Sparkle Finish
7.5J x 19" | 8.5J x 19"
225/40 R19 | 255/35 R19
029UP



19" 15 SPOKE
'STYLE 1015'

Sparkle Finish
7.5J x 19" | 8.5J x 19"
225/40 R19 | 255/35 R19
029UQ



19" 15 SPOKE
'STYLE 1015'

Black/Diamond Turned
7.5J x 19" | 8.5J x 19"
225/40 R19 | 255/35 R19
029UI

| | | | |
|--------------------|--------------|---|---|
| ALLOY WHEEL FINISH | | | |
| ALLOY WHEEL/SIZE | | | |
| TIRE SIZE | | | |
| CODE | | | |
| XE | — | — | — |
| Premium | ○ (30t only) | — | — |
| Prestige | ● (30t only) | — | — |
| Portfolio | — | ● | — |
| R-Sport | — | — | — |
| S | ○ | — | ● |



19" 5 SPLIT-SPOKE
'STYLE 5031'

Silver/Diamond Turned
7.5J x 19" | 8.5J x 19"
225/40 R19 | 255/35 R19
029UR



19" 5 SPLIT-SPOKE
'STYLE 5031'

Black
7.5J x 19" | 8.5J x 19"
225/40 R19 | 255/35 R19
029US



20" 10 SPOKE
'STYLE 1014'

Satin Grey/Diamond Turned
8J x 20" | 9J x 20"
235/35 R20 | 265/30 R20
029UG

| | | | |
|--------------------|---------------------------------|--------------|---|
| ALLOY WHEEL FINISH | | | |
| ALLOY WHEEL/SIZE | | | |
| TIRE SIZE | | | |
| CODE | | | |
| XE | — | — | — |
| Premium | — | — | — |
| Prestige | ○ | ○ (30t only) | — |
| Portfolio | — | — | — |
| R-Sport | ● (30t only)/○ (20d & 25t only) | ○ (30t only) | — |
| S | ○ | — | ○ |

5 CHOOSE YOUR INTERIOR

 Configure your vehicle at jaguarusa.com

| XE | | | | | | |
|----------------------------------|--------------------------------|---------------------------------|--------------------------------|---------------------------------|--------|-----------------------------|
| | SEAT | UPPER FASCIA | INTERIOR TRIM AND OPTION CODES | HEADLINING MORZINE | CARPET | FINISHER |
| Standard | | | | | | |
| Luxtec Seats | Ebony | Ebony | SEY | Light Oyster | Ebony | Gloss Black |
| | Latte | Ebony | SFA | Light Oyster | Ebony | Gloss Black |
| | Light Oyster | Oyster | TOZ | Light Oyster | Oyster | Gloss Black |
| PREMIUM | | | | | | |
| | SEAT | UPPER FASCIA | INTERIOR TRIM AND OPTION CODES | HEADLINING MORZINE | CARPET | FINISHER |
| Standard | | | | | | |
| Luxtec Seats | Ebony | Ebony | SEY | Light Oyster | Ebony | Gloss Black |
| | Latte | Ebony | SFA | Light Oyster | Ebony | Gloss Black |
| | Light Oyster | Oyster | TOZ | Light Oyster | Oyster | Gloss Black |
| PRESTIGE | | | | | | |
| | SEAT WITH CONTRAST STITCH | FASCIA UPPER/LOWER | INTERIOR TRIM AND OPTION CODES | HEADLINING MORZINE | CARPET | FINISHER |
| Standard | | | | | | |
| Grained leather seats | Latte with Ebony | Ebony with Latte | SFC | Light Oyster | Ebony | Dark Satin Brushed Aluminum |
| | Ebony with Sienna Tan | Ebony with Ebony | SFB | Light Oyster | Ebony | Dark Satin Brushed Aluminum |
| | Light Oyster with Pistachio | Oyster with Light Oyster | TPC | Light Oyster | Oyster | Dark Satin Brushed Aluminum |
| PORTFOLIO | | | | | | |
| | SEAT WITH TONAL STITCH | UPPER FASCIA WITH TONAL STITCH | INTERIOR TRIM AND OPTION CODES | HEADLINING MORZINE ¹ | CARPET | FINISHER |
| Standard | | | | | | |
| Perforated Windsor leather seats | Brogue with Brogue | Ebony with Ebony/Brogue | SFS | Light Oyster | Ebony | Gloss Figured Ebony |
| | Sienna Tan with Sienna Tan | Ebony with Ebony/Sienna Tan | SFR | Light Oyster | Ebony | Gloss Figured Ebony |
| | Ebony with Ebony | Ebony with Ebony/Ebony | SFQ | Light Oyster | Ebony | Gloss Figured Ebony |
| | Light Oyster with Light Oyster | Oyster with Oyster/Light Oyster | TPQ | Light Oyster | Oyster | Gloss Figured Ebony |

¹Ebony Morzine headlining available as an option.

²Light Oyster Morzine headlining available as an option.

| R-SPORT | | | | | | |
|--|--|------------------------------------|---------------------------------------|---------------------------------------|---------------|-----------------|
| | SEAT WITH CONTRAST STITCH | FASCIA | INTERIOR TRIM AND OPTION CODES | HEADLINING MORZINE | CARPET | FINISHER |
| Standard | | | | | | |
| Perforated grained leather sport seats | Ebony/Ebony with Light Oyster | Ebony with Light Oyster | SFE | Ebony | Ebony | Etched Aluminum |
| | Ebony/Pimento with Pimento | Ebony with Pimento | SFG | Ebony | Ebony | Etched Aluminum |
| | Ebony/Eclipse with Eclipse | Ebony with Eclipse | SFJ | Ebony | Ebony | Etched Aluminum |
| | Ebony/Light Oyster with Light Oyster | Ebony with Light Oyster | SFK | Ebony | Ebony | Etched Aluminum |
| S | | | | | | |
| | DUOTONE SEAT WITH CONTRAST STITCH | FASCIA WITH CONTRAST STITCH | INTERIOR TRIM AND OPTION CODES | HEADLINING MORZINE² | CARPET | FINISHER |
| Standard | | | | | | |
| Grained leather and Suedecloth sport seats | Pimento/Ebony with Ebony | Ebony with Pimento | SFM | Ebony | Ebony | Meshed Aluminum |
| | Eclipse/Ebony with Ebony | Ebony with Eclipse | SFN | Ebony | Ebony | Meshed Aluminum |
| | Light Oyster/Ebony with Ebony | Ebony with Light Oyster | SFP | Ebony | Ebony | Meshed Aluminum |
| | Ebony/Ebony with Light Oyster | Ebony with Light Oyster | SFL | Ebony | Ebony | Meshed Aluminum |
| Optional | | | | | | |
| Perforated grained leather sport seats | Pimento/Ebony with Ebony | Ebony with Pimento | SFM | Ebony | Ebony | Meshed Aluminum |
| | Eclipse/Ebony with Ebony | Ebony with Eclipse | SFN | Ebony | Ebony | Meshed Aluminum |
| | Light Oyster/Ebony with Ebony | Ebony with Light Oyster | SFP | Ebony | Ebony | Meshed Aluminum |
| | Ebony/Ebony with Light Oyster | Ebony with Light Oyster | SFL | Ebony | Ebony | Meshed Aluminum |

5 CHOOSE YOUR INTERIOR

Configure your vehicle at jaguarusa.com

Interior shown: Ebony luxtec seats with Gloss Black finisher, Light Oyster headlining and Ebony fascia.



XE & PREMIUM

INTERIOR COLOR COMBINATIONS

STANDARD

1

SEAT

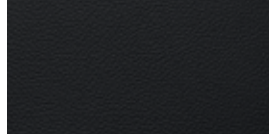

Ebony

2

FINISHER



Gloss Black

3

HEADLINING



Light Oyster

4

FASCIA



Ebony

5

CARPET



Ebony



Latte



Gloss Black



Light Oyster



Ebony



Ebony

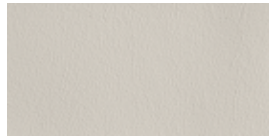

Light Oyster



Gloss Black



Light Oyster

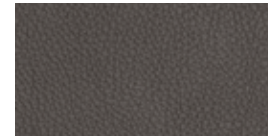

Oyster



Oyster

5 CHOOSE YOUR INTERIOR

Configure your vehicle at jaguarusa.com

Interior shown: Latte leather seats with Ebony contrast stitch, Brushed Aluminum finisher, Light Oyster headlining, Ebony upper fascia and Latte lower fascia.



PRESTIGE

INTERIOR COLOR COMBINATIONS

STANDARD

1

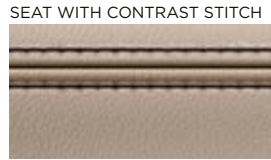

Latte with Ebony

2



Dark Satin Brushed Aluminum

3



Light Oyster

4

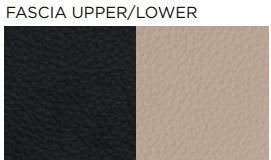

Ebony with Latte

5



Ebony



Ebony with Sienna Tan



Dark Satin Brushed Aluminum



Light Oyster



Ebony with Ebony



Ebony



Light Oyster with Pistachio



Dark Satin Brushed Aluminum



Light Oyster

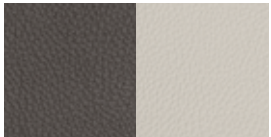

Oyster with Light Oyster



Oyster

FINISHER OPTIONS

Gloss Figured Ebony

*Console finisher is Gloss Black.

5 CHOOSE YOUR INTERIOR

Configure your vehicle at jaguarusa.com

Interior shown: Brogue leather seats with Herringbone perforations and Brogue tonal stitch. Gloss Figured Ebony veneer, Light Oyster headlining, Ebony upper fascia and Brogue lower fascia.



PORTFOLIO

INTERIOR COLOR COMBINATIONS

STANDARD

1

SEAT WITH TONAL STITCH



Brogue with Brogue

2

FINISHER*



Gloss Figured Ebony

3

HEADLINING



Light Oyster

4

FASCIA UPPER WITH TONAL STITCH/LOWER

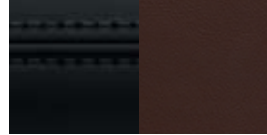

Ebony with Ebony/Brogue

5

CARPET



Ebony

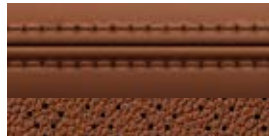

Sienna Tan with Sienna Tan



Gloss Figured Ebony



Light Oyster



Ebony with Ebony/Sienna Tan



Ebony



Ebony with Ebony



Gloss Figured Ebony



Light Oyster

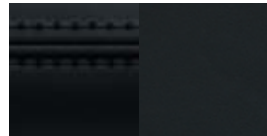

Ebony with Ebony



Ebony

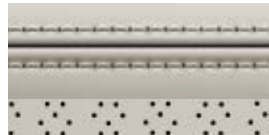

Light Oyster with Light Oyster



Gloss Figured Ebony



Light Oyster

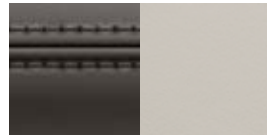

Oyster with Oyster/Light Oyster



Oyster

*Console finisher is Gloss Black.

5 CHOOSE YOUR INTERIOR

 Configure your vehicle at jaguarusa.com











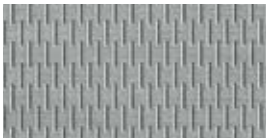

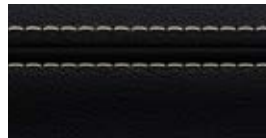

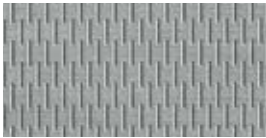

Interior shown: Ebony perforated leather sport seats with Light Oyster contrast stitch. Etched Aluminum finisher, Ebony headlining and Ebony fascia with Light Oyster contrast stitch.

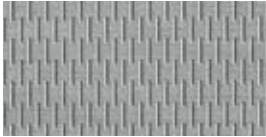

R-SPORT

INTERIOR COLOR COMBINATIONS

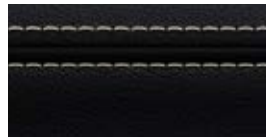
OPTIONS

| 1 | 2 | 3 | 4 | 5 |
|--|--|---|--|--|
| SEAT WITH CONTRAST STITCH | FINISHER* | HEADLINING | FASCIA | CARPET |
|  |  |  |  |  |
| Ebony/Ebony with Light Oyster | Etched Aluminum | Ebony | Ebony with Light Oyster | Ebony |
|  |  |  |  |  |
| Ebony/Pimento with Pimento | Etched Aluminum | Ebony | Ebony with Pimento | Ebony |
|  |  |  |  |  |
| Ebony/Eclipse with Eclipse | Etched Aluminum | Ebony | Ebony with Eclipse | Ebony |
|  |  |  |  |  |
| Ebony/Light Oyster with Light Oyster | Etched Aluminum | Ebony | Ebony with Light Oyster | Ebony |

FINISHER OPTIONS

Satin Burl Ash or Carbon Fiber

*Console finisher is Gloss Black.

5 CHOOSE YOUR INTERIOR

⚙️ Configure your vehicle at jaguarusa.com











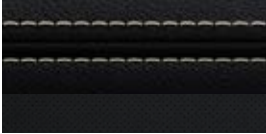
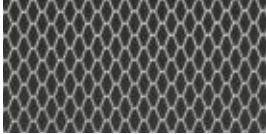

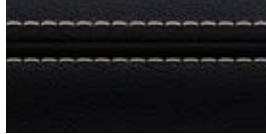

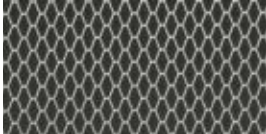

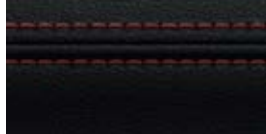
Interior shown: Pimento Leather Sport seats with Ebony Suedecloth inserts and Ebony contrast stitch. Meshed Aluminum finisher, Ebony headlining and Ebony fascia with Pimento contrast stitch.

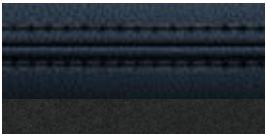
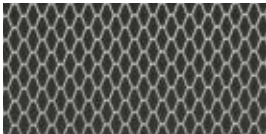

S

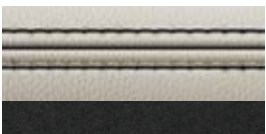
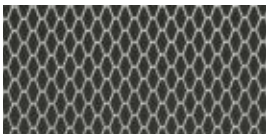
INTERIOR COLOR COMBINATIONS

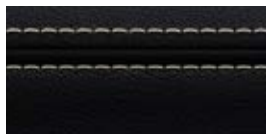
STANDARD

| 1 | 2 | 3 | 4 | 5 |
|---|---|---|---|---|
| <p>DUOTONE SEAT WITH CONTRAST STITCH</p>  <p>Ebony/Ebony with Light Oyster</p> | <p>FINISHER*</p>  <p>Meshed Aluminum</p> | <p>HEADLINING</p>  <p>Ebony</p> | <p>FASCIA WITH CONTRAST STITCH</p>  <p>Ebony with Light Oyster</p> | <p>CARPETS</p>  <p>Ebony</p> |
|  <p>Pimento Red/Ebony with Ebony</p> |  <p>Meshed Aluminum</p> |  <p>Ebony</p> |  <p>Ebony with Pimento Red</p> |  <p>Ebony</p> |
|  <p>Eclipse/Ebony with Ebony</p> |  <p>Meshed Aluminum</p> |  <p>Ebony</p> |  <p>Ebony with Eclipse</p> |  <p>Ebony</p> |
|  <p>Light Oyster/Ebony with Ebony</p> |  <p>Meshed Aluminum</p> |  <p>Ebony</p> |  <p>Ebony with Light Oyster</p> |  <p>Ebony</p> |

OPTIONS

| HEADLINING | FINISHER |
|--------------|--------------------------------|
| Light Oyster | Satin Burl Ash or Carbon Fiber |

*Console finisher is Gloss Black.

5 CHOOSE YOUR INTERIOR

⚙️ Configure your vehicle at jaguarusa.com











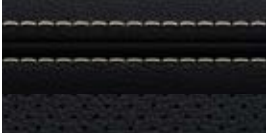
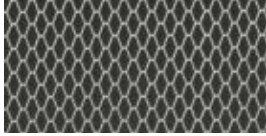

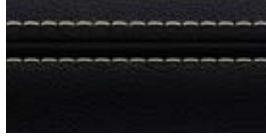

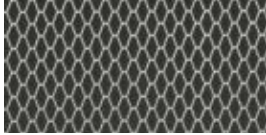

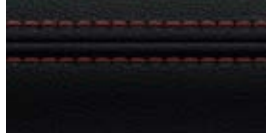
Interior shown: Ebony Perforated Leather seats with Light Oyster contrast stitch.
Meshed Aluminum finisher, Ebony headlining and Ebony fascia with Light Oyster contrast stitch.

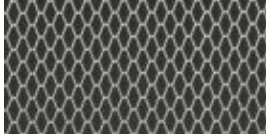

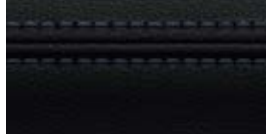
S

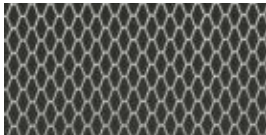
INTERIOR COLOR COMBINATIONS

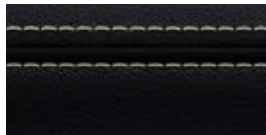
OPTIONS

| 1 | 2 | 3 | 4 | 5 |
|---|---|---|---|--|
| <p>DUOTONE SEAT WITH CONTRAST STITCH</p>  <p>Ebony/Ebony with Light Oyster</p> | <p>FINISHER*</p>  <p>Meshed Aluminum</p> | <p>HEADLINING</p>  <p>Ebony</p> | <p>FASCIA WITH CONTRAST STITCH</p>  <p>Ebony with Light Oyster</p> | <p>CARPET</p>  <p>Ebony</p> |
|  <p>Pimento Red/Ebony with Ebony</p> |  <p>Meshed Aluminum</p> |  <p>Ebony</p> |  <p>Ebony with Pimento Red</p> |  <p>Ebony</p> |
|  <p>Eclipse/Ebony with Ebony</p> |  <p>Meshed Aluminum</p> |  <p>Ebony</p> |  <p>Ebony with Eclipse</p> |  <p>Ebony</p> |
|  <p>Light Oyster/Ebony with Ebony</p> |  <p>Meshed Aluminum</p> |  <p>Ebony</p> |  <p>Ebony with Light Oyster</p> |  <p>Ebony</p> |

OPTIONS

| HEADLINING | FINISHER |
|--------------|--------------------------------|
| Light Oyster | Satin Burl Ash or Carbon Fiber |

*Console finisher is Gloss Black.

5 CHOOSE YOUR INTERIOR

 Configure your vehicle at jaguarusa.com

Gloss Black

Dark Satin Brushed Aluminum

Etched Aluminum

Meshed Aluminum

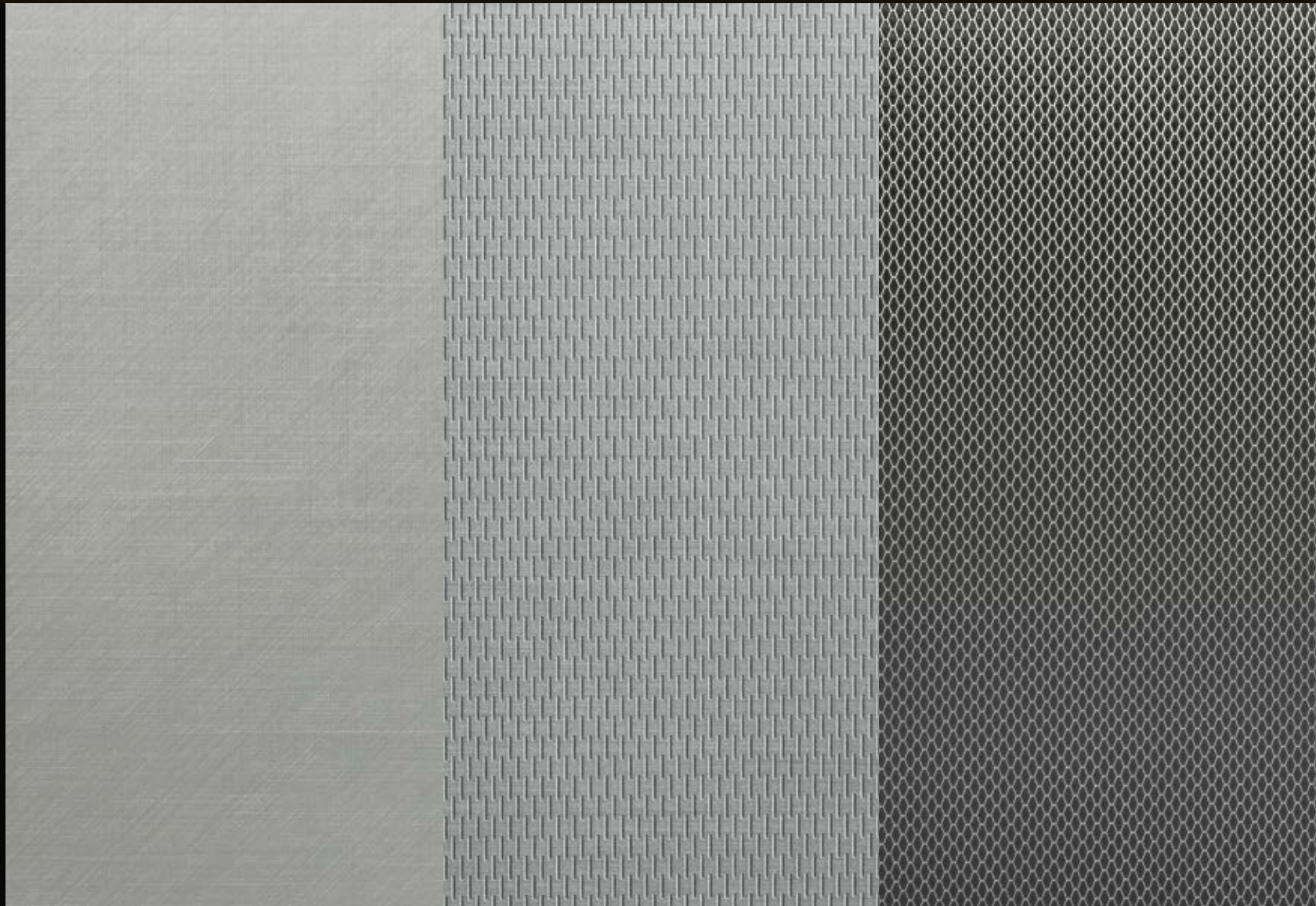

Carbon Fiber



Satin Burl Ash



Gloss Figured Ebony



6 CHOOSE YOUR JAGUAR GEAR - ACCESSORIES

The genuine range of accessories from Jaguar.



Roof Mounted Cycle Carrier¹ **C2A1539**

An easy to fit, roof mounted, lockable cycle carrier which carries one bike per holder. A maximum of three holders can be fitted.

¹Requires roof cross bars T4N20453.

VEHICLE SHOWN: JAGUAR XE S IN FIRENZE RED WITH OPTIONAL EQUIPMENT



Personalized Illuminated Sill Treadplates
T4N7511

Elegantly styled stainless steel sill treadplate finishers for driver or passenger doors. Illuminates when either the driver or passenger doors are opened. Highlighted by soft Phosphor Blue lighting. Allows customer to specify a monochrome 'motif' in a choice of approved typefaces/scripts.



Aluminum Gearshift Paddles
T2R6547MMU

Replacement steering wheel gearshift paddles offered in a premium aluminum material providing a high quality finish to a key contact point in the vehicle. Manufactured from billet machined aluminum, the paddles are hand brushed for a premium finish and anodized to ensure they will not deteriorate with wear.



Central Armrest Chiller/Warmer
T2H7739

Food and drinks chiller and warmer that acts as a rear center armrest. With a leather-covered top, it is held in place by the center seat belt and powered from the rear auxiliary socket. Ideal for long journeys with the family.



Sport Pedal Covers
T2H3746

Made from stainless steel and rubber, the pedal kit fits securely over existing pedals for a contemporary, sporting appearance.



Rubber Mats
T4N7496 - LHD
T4N16396 - LHD AWD

Hard wearing Jaguar branded rubber mats provide added protection for your vehicle's carpets.



Premium Luggage Compartment Carpet Mat
T4N7147PVJ

Luxurious soft luggage mat in Jet Black with the Jaguar logo. Deep premium 6.72oz/ft² pile with Nubuck edging and Dove contrast stitch.

6 CHOOSE YOUR JAGUAR GEAR ACCESSORIES

 Configure your vehicle at jaguarusa.com



Gloss Black Side Power Vent
T4N16033 - Left Side
T4N16029 - Right Side

Gloss Black side power vents provide a dynamic exterior styling enhancement.



Carbon Fiber Side Power Vent
T2H6208 - Left Side
T2H6209 - Right Side

High-grade Carbon Fiber side power vents provide a performance-inspired styling upgrade.



Chrome Grille
T4N10516

Provides a Chrome finish to the grille surround and bumper beam accentuating the XE's luxury appearance.



Gloss Black Mirror Cover
C2D6066PEC - Left Side
C2D6067PEC - Right Side

Gloss Black mirror covers accentuate the dynamic design of the exterior mirrors.



Carbon Fiber Mirror Cover
C2P24176 - Left Side
C2P24177 - Right Side

High-grade Carbon Fiber mirror covers provide a performance-inspired styling upgrade.



Chrome Mirror Cover
C2D5489 - Left Side
C2D5488 - Right Side

Chrome mirror covers accentuate the stylish design of the exterior mirrors.

¹Requires roof cross bars T4N4709. ²For XE, XE Premium, Prestige and Portfolio.



Roof Cross Bars
T4N20453

Jaguar branded cross bars required for fitting all roof carrying equipment. Engineered specifically for your vehicle.



Watersports Carrier¹
C2Z21730

A versatile system for transporting a variety of water sports equipment including surfboard, kayak or sailboard. Tilts to facilitate loading/unloading.



Roof Sport Box¹
C2C41627

Spacious 11 cubic feet capacity lockable roof box designed for sports equipment, measuring 81 x 33 x 13 inches.



Chrome Front Splitter²
T4N7599

Give the XE an even more stylish look with this bright finish front splitter blade. Body-colored rear spoiler is also available. (T4N5462LML)



Rear Splash Guards
T4N7514

Jaguar branded, rear splash guards complement the lines of your vehicle and provide protection from dirt and stone chippings.



All-Weather Car Cover
T4N7502

All-weather tailored cover for the XE with the Jaguar logo. Protect your XE from the elements, including showers, frost and dust. Quick and easy to fit.

TECHNICAL DETAILS

 Configure your vehicle at jaguarusa.com

| ENGINES | | 20d 2.0 LITER 4-CYLINDER TURBOCHARGED DIESEL | | 25t 2.0 LITER 4-CYLINDER TURBOCHARGED GAS | |
|--|------------|--|--|---|--|
| Capacity | cc | 1,999 | | 1,998 | |
| Maximum power | HP | 180 | | 247 | |
| @rev/min | rpm | 4,000 | | 5,500 | |
| Maximum torque | lb-ft | 317 | | 269 | |
| @rev/min | rpm | 1,750-2,500 | | 1,300-4,500 | |
| PERFORMANCE | | AUTO RWD | | AUTO AWD | |
| 0-60 mph | seconds | 7.6 | | 7.8 | |
| Top speed | mph | 120 limited | | 120 limited | |
| DIMENSIONS | | | | | |
| Overall length | in | 183.9 | | 183.9 | |
| Overall width (inc. mirrors) | in | 81.7 | | 81.7 | |
| Overall width (mirrors folded) | in | 77.4 | | 77.4 | |
| Overall height | in | 55.8 (RWD) 56.1 (AWD) | | 55.8 (RWD) 56.1 (AWD) | |
| Wheelbase | in | 111.6 | | 111.6 | |
| Front track | in | 62.9-63.1 | | 62.9-63.1 | |
| Rear track | in | 62.4-63.1 | | 62.4-63.1 | |
| Ground clearance | in | 3.9 | | 3.9 | |
| Turning circle diameter (curb-to-curb) | ft | 36.8 | | 36.8 | |
| Trunk volume | cu.ft. | 16.1 | | 16.1 | |
| Tank capacity (usable) | US gallons | 14.8 | | 16.6 | |
| WEIGHT ¹ | | | | | |
| Curb Weight | lb | 3,450 | | 3,545 | |
| Gross vehicle weight | lb | 4,825 | | 4,735 | |
| ENGINE AVAILABILITY | | | | | |
| XE | | ● | | ● | |
| Premium | | ● | | ● | |
| Prestige | | ● | | ● | |
| Portfolio | | — | | — | |
| R-Sport | | ● | | ● | |
| S | | — | | — | |

● Available — Not Available

¹Weights reflect vehicles to standard specifications. Optional extras increase weight.

| 3.0L 2.0 LITER 4-CYLINDER TURBOCHARGED GAS | | S 3.0 LITER V6 SUPERCHARGED GAS | |
|--|-----------------------|---------------------------------------|-----------------------|
| | 1,998 | | 2,995 |
| | 296 | | 380 |
| | 5,500 | | 6,500 |
| | 295 | | 332 |
| | 1,500-4,500 | | 4,500 |
| AUTO RWD | AUTO AWD | AUTO RWD | AUTO AWD |
| 5.6 | 5.4 | 4.8 | 4.8 |
| 120 limited | 120 limited | 121 limited | 121 limited |
| | 183.9 | | 183.9 |
| | 81.7 | | 81.7 |
| | 77.4 | | 77.4 |
| | 55.8 (RWD) 56.1 (AWD) | | 55.8 (RWD) 56.1 (AWD) |
| | 111.6 | | 111.6 |
| | 62.9-63.1 | | 62.9-63.1 |
| | 62.4-63.1 | | 62.4-63.1 |
| | 3.9 | | 3.9 |
| | 36.8 | | 36.8 |
| | 16.1 | | 16.1 |
| | 16.6 | | 16.6 |
| | 3,430 | | 3,635 |
| | 4,760 | | 4,915 |
| | 3,560 | | 3,915 |
| | 4,870 | | 5,025 |
| | — | | — |
| | ● | | — |
| | ● | | — |
| | ● | | — |
| | ● | | — |
| | — | | ● |

DIMENSIONS

Overall Width (inc mirrors) 81.7 inches

Overall Width (mirrors folded) 77.4 inches

Trunk Volume 16.1 cu.ft.



Turning Circle
Curb-to-Curb 36.8 ft

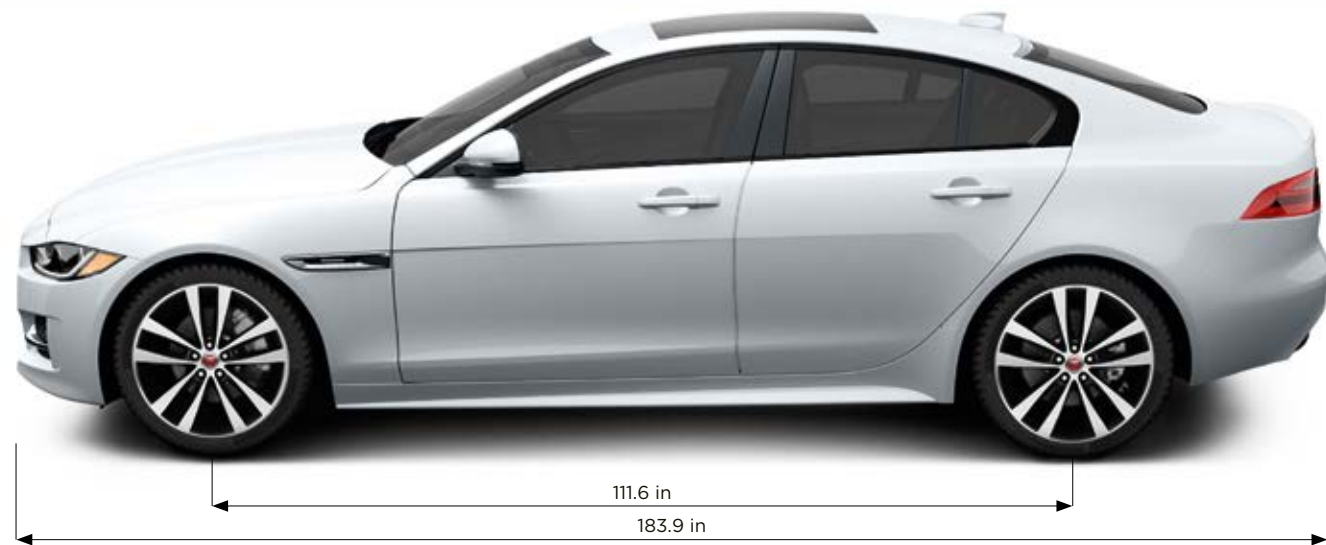

Dimensions were measured with vehicle at unladen mass
(measured by VDA standard test method using 200 x 100 x 50mm blocks).

VEHICLE SHOWN: JAGUAR XE R-SPORT IN YULONG WHITE WITH OPTIONAL EQUIPMENT

SPECIAL VEHICLE OPERATIONS



Special Vehicle Operations (SVO) designs and engineers products that amplify Jaguar and Land Rover core brand values; focusing on luxury, performance and capability.

Our team of specialists is completely focused on enhancing and personalizing our relationship with our most discerning and enthusiastic customers – delivering experiences that our customers will love for life.

SVO is responsible for the creation of a suite of halo products that showcase the pinnacle of Jaguar design and engineering capabilities, enabling our customers to indulge their passion for spectacular new vehicles.

THE NEW SVO TECHNICAL CENTER

In the heart of the British Midlands is SVO's brand new Technical Center. This state-of-the-art facility represents a \$25 million dollar investment by Jaguar Land Rover, and features four zones designed to support the creation of truly breath-taking vehicles. In addition to the Commissioning and Presentation suites, our manufacturing center is responsible for the assembly and hand-finishing of SVO halo and Collector's Edition vehicles, and a world-class paint facility ensures an exquisite finish for every vehicle we create.

BESPOKE BY SVO

Bespoke by SVO was born out of an innate understanding of what our most discerning clients value more than anything else – to own something completely unique to them. Something only they can have, reflecting who they are and what they hold most dear. With that in mind, SVO developed innovative Commissioning and Presentation suites enabling creation of the most refined and luxurious vehicles in the world. This special new facility is housed within the new SVO Technical Center in Warwickshire, England.





THE WORLD OF JAGUAR

Choose XE and you're joining the exciting World of Jaguar.

BEHIND THE SCENES

Our factory tours give you the unique opportunity to experience the whole process of how our vehicles are brought to life - from the molding of sheet metal to those intricate final touches. At our state-of-the-art production facilities, you'll get to see how skilled technicians and sophisticated machines work seamlessly together to perfect some of Jaguar's most breathtaking cars.

Find out more at jaguarusa.com

ICE DRIVE EXPERIENCES

Take your driving to the next level with the Jaguar Land Rover Ice Drive Experience. We currently offer an adventure in Arjeplog, Sweden, that will test and develop your performance driving skills in extreme conditions. It's a rare chance for owners and enthusiasts to tackle some of the harshest and most challenging tracks on earth, under the skilled guidance of our experts. Our driving instructors are of the highest-caliber and will be with you every step of the way - ready to impart years of driving wisdom. You will dance on ice, glide around some of the most awe-inspiring corners imaginable and realize the true exhilarating potential of Jaguar and Land Rover.

If you'd like to be part of the next adventure, find out more by visiting jaguarusa.com





FORMULA E

Jaguar's reputation for performance, technology and design was forged by the world's most challenging circuits and championships. From Le Mans to Formula 1, and now Formula E, the grid is our test-bed. Formula E provides the perfect proving ground for electric vehicle technology in a high performance environment. The racing series accelerates the development of Jaguar's electric powertrains. With every race, Formula E helps Jaguar engineers create better electric vehicles.



JAGUAR COLLECTION

The latest from the Jaguar Collection has been crafted with the same design execution and attention to detail that goes into all of our vehicles. This is evident in our clothing range, premium leather items and luxury travel goods. To celebrate Jaguar's heritage, we also have a collection that honors past achievements and features race inspired gift items and apparel.

Visit shop.jaguarusa.com to browse the Jaguar collection.

THE JAGUAR MAGAZINE

This is our own vibrant, cosmopolitan and contemporary magazine. Produced by a team of enthusiastic designers and feature writers, it goes behind the scenes at Jaguar as well as providing insight into the world of luxury, design, style and travel.





AT YOUR SERVICE

As well as providing a range of exclusive services and lifestyle products, the World of Jaguar makes owning and driving carefree and easy.

JAGUAR ELITECARE*

Enjoy your Jaguar with peace of mind. The Jaguar XE is backed by Jaguar EliteCare, our coverage program including New Vehicle Limited Warranty, Complimentary Scheduled Maintenance, Roadside Assistance and Jaguar InControl Remote & Protect™.

GENUINE PARTS

Jaguar vehicles Genuine Parts are designed, tested and manufactured to our uncompromising standards for quality, fit and durability. Each part is engineered specifically for your Jaguar XE to contribute to optimum performance and to help maximize its lifespan.

FLEET & BUSINESS

Jaguar vehicles are dynamic and distinctive and that help companies express the unique character and personality of their business. We are committed to providing customer focused aftersales services, ensuring that every Jaguar performs to the highest standard and in the most cost-efficient way for businesses. Visit jaguarusa.com for more information.

JAGUAR ASSISTANCE

Jaguar Assistance provides assistance in motoring emergencies, from immobilization due to mechanical breakdown to minor problems such as punctures. You can rely on our roadside assistance, whatever the situation, anywhere in North America during the vehicles warranty period.

JAGUAR FINANCIAL SERVICES

New or used, for personal or business use, we have a finance option that puts you in complete control. Please speak to your local Jaguar Retailer to find out more.

IMPORTANT NOTICE

Jaguar Land Rover Limited is constantly seeking ways to improve the specification, design and production of its vehicles, parts and accessories and alterations take place continually. Whilst every effort is made to produce up to date literature, this brochure should not be regarded as an infallible guide to current specifications or availability, nor does it constitute an offer for the sale of any particular vehicle, part or accessory. Distributors and retailers are not agents of Jaguar Land Rover Limited by any express or implied undertaking or representation.

COLORS

The colors reproduced here are subject to the limitations of the printing process and may therefore vary slightly from the actual vehicle. The company reserves the right to alter or withdraw any color finish without notice. Some of these colors may not be obtainable in your country. Please check availability of colors and current specifications with your Jaguar Retailer. Distributors and Retailers are not agents of Jaguar Land Rover Limited and have absolutely no authority to bind Jaguar Land Rover Limited to any express or implied undertaking or representation.

ENVIRONMENTAL INNOVATION AT JAGUAR

Jaguar is committed to reducing dependency on fossil fuels, using fewer natural resources and creating less waste as part of our approach to responsible and sustainable business development.

Search 'Jaguar Environmental Innovation' for more details.

*For complete details regarding Jaguar EliteCare coverage, please visit JAGUARUSA.COM, call 1.800.4.JAGUAR or visit your local Jaguar Retailer.

Castrol EDGE Professional recommended by Jaguar.

Meridian is the trademark of Meridian Audio Ltd.

The Bluetooth® word mark and logos are owned by the Bluetooth SIG, Inc. and any use of such marks by Jaguar Land Rover Limited is under license. iPhone is a trademark of Apple Inc., registered in the US and other countries.

VEHICLE SHOWN FRONT AND BACK COVER: JAGUAR XE LANDMARK EDITION IN YULONG WHITE WITH OPTIONAL EQUIPMENT

Jaguar Land Rover North America, LLC
100 Jaguar Land Rover Way
Mahwah, NJ 07495

jaguarusa.com

© 2018 Jaguar Land Rover North America, LLC

1X7601900000BUSEN01P

