



ABOVE & BEYOND

[CONTENTS](#)

[SPECIFICATIONS](#)

[FIND A RETAILER](#)

[BUILD YOUR OWN](#)

DISCOVERY

2018



ABOVE & BEYOND





ABOVE & BEYOND

CONTENTS

SPECIFICATIONS

FIND A RETAILER

BUILD YOUR OWN



BY APPOINTMENT TO
HM THE QUEEN
MANUFACTURERS OF
MOTOR VEHICLES
JAGUAR LAND ROVER LIMITED
COVENTRY



BY APPOINTMENT TO
HRH THE DUKE OF EDINBURGH
MANUFACTURERS OF
MOTOR VEHICLES
JAGUAR LAND ROVER LIMITED
COVENTRY



BY APPOINTMENT TO
HRH THE PRINCE OF WALES
MANUFACTURERS OF
MOTOR VEHICLES
JAGUAR LAND ROVER LIMITED
COVENTRY



ABOVE & BEYOND

Ever since the first Land Rover vehicle was conceived in 1947, we have built vehicles that challenge what is possible. These in turn have challenged their owners to explore new territories and conquer difficult terrains. Our vehicles epitomize the values of the designers and engineers who have created them. Each one instilled with iconic British design cues, delivering capability with composure. Which is how we continue to break new ground, defy conventions and encourage each other to go further. Land Rover truly enables you to make more of your world, to go above and beyond.





ABOVE & BEYOND

CONTENTS

SPECIFICATIONS

FIND A RETAILER

BUILD YOUR OWN



CONTENTS

INTRODUCTION

The Concept of the Discovery 6
Discovery – The Facts 8

DESIGN

Exterior 11
Interior 15
Seven Full-Size Seats 19
Remote Intelligent Seat Fold 19
Space and Comfort 21
Storage 22
Powered Inner Tailgate 24
Powered Gesture Tailgate 24
Cargo space Capacity 26

DRIVING TECHNOLOGY

Testing 28
All Terrain Technology 31
Terrain Response® 31
All Terrain Progress Control 31
Hill Descent Control (HDC®) 32
Permanent All Wheel Drive Systems 35

Suspension 35
Efficient Technologies 37
On-Road Dynamics 38

TECHNOLOGY

Infotainment 41
Audio 42
Connectivity 44

DRIVING TECHNOLOGY

Driver Assistance 50
Driving Aids 54
Towing Aids 56

COMFORT FOR ALL

Activity Key 61
65

ENGINES

8-Speed Automatic Transmission 67
Gas Engine 68
Diesel Engine 69

BODY AND CHASSIS

Strength and Stability 70

SAFETY

72

ENVIRONMENTAL

Sustainability 75

SPECIFICATIONS

Choose Your Engine 78
Choose Your Model and Options 80
Choose Your Color 100
Choose Your Wheels 104
Choose Your Interior 106
Choose Your Land Rover Gear – Accessories 114

TECHNICAL DETAILS

120

A WORLD OF LAND ROVER

122



Scan to view the Discovery in action.

Vehicles shown are from the Land Rover global range. Vehicles shown feature optional wheels and a number of optional features. Specifications, options and availability will vary between markets and should be verified with your nearest Land Rover Retailer. Vehicle shown left is HSE Luxury in Namib Orange.

DESIGN

DRIVING CAPABILITY

DRIVING TECHNOLOGY

COMFORT FOR ALL

ENGINES

BODY AND CHASSIS

SAFETY

ENVIRONMENTAL



ABOVE & BEYOND

CONTENTS

SPECIFICATIONS

FIND A RETAILER

BUILD YOUR OWN

INTRODUCTION

THE CONCEPT OF THE DISCOVERY

Ever since it first took to the streets, mud tracks and deserts in 1989, the Discovery has blazed its own trail. From Alaska to Zambia, it has become synonymous with capability and versatility, whether off-road or in the city. The Discovery takes those characteristics, together with several innovations pioneered by Land Rover, to uncharted territories.

The Discovery is a quantum leap forward in SUV Design. A radical and sharply focused approach to embodying Land Rover's vision of the most versatile and capable SUV.

The Discovery combines the flexibility of a beautifully crafted full-size seven seat* interior, packed full of ingenious design details, with dramatic proportions, clean modern lines and a dynamic silhouette.

So wherever you want to go, whoever and whatever you want to take, the Discovery is every vehicle you'll ever need.

*Available as part of a package on SE and HSE and standard on HSE Luxury. Vehicle shown right is HSE Luxury in Namib Orange.



DESIGN

DRIVING CAPABILITY

DRIVING TECHNOLOGY

COMFORT FOR ALL

ENGINES

BODY AND CHASSIS

SAFETY

ENVIRONMENTAL



ABOVE & BEYOND

CONTENTS

SPECIFICATIONS

FIND A RETAILER

BUILD YOUR OWN

DISCOVERY – THE FACTS

Form, function and exemplary levels of finesse are brought together to help create one of Land Rover’s most compelling vehicles to date. Its inherent strength and off-road capabilities are matched only by its bold contemporary looks and alluring touches of luxury. Inside, astute use of space coupled with high quality design and use of premium materials enhance the vehicle’s bold horizontal and vertical lines.

The versatility of the cabin is highlighted by the easily configurable seven seat* layout and plentiful storage, with clever use of space and refined comfort.

SEVEN FULL-SIZE SEATS* WITH INTELLIGENT SEAT FOLD**

Discovery features three rows of seats with Intelligent Seat Fold allowing you to configure the second and third row seating using switches located in the cargo space or on the main Touchscreen[†]. Furthermore, using technology pioneered by Land Rover, Discovery allows you to remotely configure the seats when you’re not in your vehicle, via an app on your smartphone. See page 19 for details.

UNCOMPROMISED CARGO SPACE CAPACITY

With over 82.7 cu.ft of cargo space, ideal for wet or dirty gear, and the flexibility of seven seats*, the Discovery is every vehicle you’ll ever need. See page 26 for details.

INTERACTIVE DRIVER DISPLAY AND HEAD-UP DISPLAY[°]

The Discovery ensures you’re always entertained, informed and connected with a high-resolution Interactive Driver Display. Head-up Display is an additional option that presents key vehicle data such as speed and navigation directions on the windshield. See page 41 for details.

ACTIVITY KEY

A first for Land Rover, the optional Activity Key lets you live life to the full. Housed in a robust and fully waterproof wristband, it allows you to pursue a range of activities from sailing to skydiving, safe in the knowledge that your vehicle is always protected. See page 65 for details.

POWERED INNER TAILGATE

This hands-free system provides a seating and loading platform and can also be used as a load retention barrier for when the tailgate is open. See page 24 for details.

TOWING ABILITY

Over the years, the Land Rover has earned many accolades around the world for its towing capabilities, which is why so many would naturally expect this vehicle to live up to the most demanding expectations. It doesn’t disappoint. The Discovery takes it to a new level, delivering an impressive towing capacity of up to 8,201 lbs[‡], ensuring it measures up to the vehicle’s proud DNA. See page 56 for details.

SUPREME CAPABILITY

The vehicle’s lineage and DNA are without question. Its all-terrain capability and features such as Terrain Response[®] 2^Δ ensure that the Discovery is always ready to get out there and tackle whatever comes over the horizon, no matter where that happens to be. See page 31 for details.

INTERIOR COMFORT

Passengers enjoy optimum comfort, unparalleled views and benefit from the new optional Cabin Air Ionization technology, helping improve the air quality within the vehicle cabin. See page 61 for details.

THOUGHTFUL STORAGE

From the fold down storage behind the climate controls, to the upper and lower glovebox and a comprehensive space below the center console cupholders, the Discovery has storage in places you simply would not expect. See page 22 for details.

INTUITIVE CONNECTIVITY

The Discovery features the very latest suite of technologies, including Land Rover InControl[®], multiple USB ports and the latest in infotainment to keep you and your passengers connected and entertained[†]. See page 46 for details.

*Available as part of a package on SE and HSE and standard on HSE Luxury.

**Available as part of a package on HSE and standard on HSE Luxury.

†Do not use Land Rover InControl[®] features under conditions that will affect your safety or the safety of others. Driving while distracted can result in loss of vehicle control.

‡Towing capacity on Si6 engine only. Towing capacity for Td6 engine is 7,716 lbs.

Δ These systems are not a substitute for driving safely with due care and attention and will not function under all circumstances, speeds, weather and road conditions, etc. Driver should not assume that these systems will correct errors of judgment in driving. Please consult the owner’s manual or your local authorized Land Rover Retailer for more details.

°Not available on SE models.

For full feature and option availability please refer to the accompanying Specification and Price Guide or visit your nearest Land Rover Retailer.



ABOVE & BEYOND

CONTENTS

SPECIFICATIONS

FIND A RETAILER

BUILD YOUR OWN



DESIGN

EXTERIOR

The vehicle's exterior design is a revolutionary re-imagining of Land Rover for the next generation.

The Discovery is beautifully proportioned for a full-size SUV, with sleek, wrap-around headlights and tail lights combining with short front and rear overhangs to reduce visual length. A pronounced windshield angle, rising belt line and elegant, smoothly contoured shape, result in a streamlined and dynamic form which combines aerodynamic efficiency with exceptional interior space. The body-colored c-pillar, stepped roof and asymmetric element on the rear number plate panel all refer to the rich lineage of previous Land Rover model designs.

Vehicle shown left is HSE Luxury in Namib Orange.



ABOVE & BEYOND

CONTENTS

SPECIFICATIONS

FIND A RETAILER

BUILD YOUR OWN



Clean flush elements, a dynamic rising waistline and wrap-around lights convey a strong sense of modernity. Beautifully designed LED lights have been developed to wrap-around the side of the vehicle to enable the indicators to be more visible. LED lights are fitted as standard on HSE and HSE Luxury and available as an option on SE.



The Discovery introduces a new level of refinement as demonstrated by its beautifully crafted and sculpted surfaces. The distinctive roof and feature lines rising towards the rear of the vehicle give it an assertive, recognizable stance that is further enhanced by the front and rear graphics. Sophisticated and urbane, the Discovery epitomizes the most compelling contemporary British design.



ABOVE & BEYOND

CONTENTS

SPECIFICATIONS

FIND A RETAILER

BUILD YOUR OWN



INTERIOR

The highly desirable interior is a re-imagining of the classic Land Rover design elements with the striking use of strong horizontal and vertical lines connecting through the main dashboard beam. The use of materials such as premium leather, authentic wood and metal trim, coupled with focused craftsmanship and precision, create an air of cultured modern living.

The 10" infotainment Touchscreen* helps you connect to the outside world and puts a wealth of entertainment and information at your fingertips. The astute use of both seating design and storage space helps deliver exceptional capability for you, your family and friends.

The new 12.3" Interactive Driver Display*† ensures you're always entertained, informed and connected. See page 41 for details.

*Driving while distracted can result in loss of vehicle control. Do not operate, adjust or view the navigation or multimedia systems under conditions that will affect your safety or the safety of others. Only use mobile phones and other devices, even with voice commands, when it is safe to do so. †Standard on HSE and HSE Luxury. Optional on SE.

Interior shown is HSE Luxury in Light Oyster/Espresso.



ABOVE & BEYOND

CONTENTS

SPECIFICATIONS

FIND A RETAILER

BUILD YOUR OWN



UNCOMPROMISING ATTENTION TO DETAIL

An eye for detail. The finest materials. These are the qualities that our designers have carefully considered to help shape the interior. Added to which, sumptuous leather, beautifully finished handcrafted wood veneers, Noble Chrome details, Brushed Aluminum finishers and crafted stitching can be incorporated throughout the interior for added luxury.



Interior shown is HSE Luxury in Light Oyster/Espresso.



ABOVE & BEYOND

CONTENTS

SPECIFICATIONS

FIND A RETAILER

BUILD YOUR OWN



SEVEN FULL-SIZE SEATS*

The seven full-size seats* truly exemplify comfort and versatility. Divided across three rows and readily deployable, the Discovery is very well appointed. For instance, the second row enjoys a 60:40 slide and recline configuration, coupled with a load-through capability. Stadium seating ensures everyone can see the road ahead in the greatest comfort while the stepped roof allows for greater headroom in the second and third rows; such thoughtful use of space ensures everyone travels in comfort. Added to which, there are a number of comfort features available including heated seats across all three rows and cooled seats on the first and second row; please refer to page 90 for a full list of available options.

REMOTE INTELLIGENT SEAT FOLD**

On HSE and HSE Luxury, with third row seats, there's a choice of ways you can easily deploy the seats with our optional Remote Intelligent Seat Fold: from the Touchscreen†, switches located in the cargo space or via our innovative app from your smartphone. Imagine standing in a grocery line, using your smartphone app to reconfigure the seats in your Discovery to accommodate your shopping bags plus your children. The powered seat folding mechanism uses an intelligent control system which ensures the seats, including the headrests, fold away seamlessly and conveniently. The system understands when seats are occupied or have heavy items on them and, when folding, automatically adjusts their position to prevent interference.

*Available as part of a package on SE and HSE and standard on HSE Luxury. **Available as part of a package on HSE and standard on HSE Luxury. †Driving while distracted can result in loss of vehicle control. Do not operate, adjust or view the navigation or multimedia systems under conditions that will affect your safety or the safety of others. Only use mobile phones and other devices, even with voice commands, when it is safe to do so.



ABOVE & BEYOND

CONTENTS

SPECIFICATIONS

FIND A RETAILER

BUILD YOUR OWN



1 Second row legroom 37.5"

2 Third row legroom 33.5"

SPACE AND COMFORT

Each and every passenger in the Discovery enjoys a truly comfortable ride, with a generous amount of legroom offered. Those in the second row will find they have 37.5", while in the optional third row, a plentiful 33.5" is provided.

Even a team of seven adults can travel in comfort. And with slide and recline specified, you can configure the second row to optimize the available room even further.

Vehicle shown left is HSE Luxury in Silicon Silver. Interior shown above is HSE Luxury in Light Oyster/Espresso.



ABOVE & BEYOND

CONTENTS

SPECIFICATIONS

FIND A RETAILER

BUILD YOUR OWN



STORAGE

The Discovery is brimming with thoughtful spaces in which to store away items you need to keep in your vehicle. From the upper and lower glovebox to central armrest storage with an optional cooler compartment, you'll find space in places you simply wouldn't expect.

The central armrest storage box can hinge back 180° to create a flat tray, should second row passengers require more storage, the door bins can also accommodate one liter bottles in the front and half liter bottles in second row. Standard on HSE and HSE Luxury, a neatly integrated push-operated hook to hang a small shopping bag sits flush in the front passenger footwell when not in use.

When third row seats* are selected, third row passengers benefit from individual storage spaces including within the side panel. In fact, across all rows there's more than enough space for even the most demanding of families.



Center console storage with an optional cooler compartment



Center console storage behind the climate controls**



Cupholders with additional storage beneath**



Upper and lower glovebox



Push operated hook**



Third row storage with lid



ABOVE & BEYOND

CONTENTS

SPECIFICATIONS

FIND A RETAILER

BUILD YOUR OWN



POWERED INNER TAILGATE

The Discovery features a powered inner tailgate, which when deployed can provide a platform for use at social and sporting events coupled with greater protection from the elements under the open tailgate. This platform also allows for easier loading and acts as a retainer when the cargo space area is filled. Powered inner tailgate is fitted as standard on HSE and HSE Luxury, and available as an option on SE.



POWERED GESTURE TAILGATE

Powered gesture tailgate allows you to operate the tailgate (both to open and close) from outside the vehicle without needing to physically touch the vehicle or the smart key.

Provided that the smart key is detected, the tailgate may be operated by foot movement underneath the rear corner of the vehicle.

Two sensors mounted on either side of the tailgate allow curbside operation, rather than needing to be immediately behind the vehicle. And as the system is compatible with towing solutions, you can still open and close the tailgate with the least amount of fuss. Powered gesture tailgate is fitted as standard on SE, HSE and HSE Luxury.

Additionally, a button located inside the tailgate or on the smart key allows the tailgate to be closed automatically.





ABOVE & BEYOND

CONTENTS

SPECIFICATIONS

FIND A RETAILER

BUILD YOUR OWN



CARGO SPACE CAPACITY

With a luggage-devouring 82.7* cu.ft. of space behind the first row of seats, the Discovery welcomes an active lifestyle. There's a generous 45* cu.ft. of space behind the second row of seats. Even when you utilize all seven seats you can still fit up to three carry-on bags behind the available third row. When it comes to carrying any load, having the option to fold all second and third row seats gives you more options, making life that much easier.



7 SEATS



6 SEATS



5 SEATS



4 SEATS



4 SEATS



3 SEATS



2 SEATS

*Cargo capacity figures represent vehicles fitted with Two or Three-zone Climate Control only. Vehicle shown is HSE Luxury in Silicon Silver. Interior shown is HSE Luxury in Light Oyster/Espresso.



ABOVE & BEYOND

CONTENTS

SPECIFICATIONS

FIND A RETAILER

BUILD YOUR OWN

DRIVING CAPABILITY

TESTING

Before any vehicle can carry the Land Rover badge, it must complete a series of rigorous tests to establish the very highest levels of luxury, performance and capability.



SUSPENSION

You're unlikely to push any Land Rover harder than we have. For an unrivalled breadth of dynamic capability both on and off-road, the vehicles have been exposed to ten years of the most extreme driving stresses in a fraction of the time using our state-of-the-art test rig.



WIND SPEED

The Discovery was developed in state-of-the-art wind tunnels and a suite of climatic chambers to recreate some of the most challenging aerodynamic conditions it will face. Only by pushing all systems to their limits do we develop true reliability.



HOT AND COLD CLIMATE

In real world environments and our climate chambers, we freeze vehicles to -40°F and bake them to 120°F. Key functions and systems are then scrutinized to our exacting standards. So even in the most remote locations, comfort and peace of mind are never far away.



OFF-ROAD

From the icy proving grounds of Arjeplog, Sweden, to Dubai's unforgiving desert sands, we ensure our legendary all-terrain performance is innate in every vehicle. Prototypes are developed across approximately 5,300 miles of the most demanding off-road routes.



SEMI-ANECHOIC CHAMBER

In the 'neutral sound' of our semi-anechoic chamber we precisely expose the cabin to a range of frequencies and vibrations, making certain that the Discovery sounds refined at every speed and across every surface.



MONSOON

Our water testing facilities ensure each vehicle can enter and exit a body of water without a single droplet entering the cabin. In the monsoon simulator, each one is drenched with some 19,000 gallons of specially dyed water, while tilting it by as much as 45°, checking for even the slightest leak with UV lights.



DESIGN

DRIVING CAPABILITY

DRIVING TECHNOLOGY

COMFORT FOR ALL

ENGINES

BODY AND CHASSIS

SAFETY

ENVIRONMENTAL



ABOVE & BEYOND

CONTENTS

SPECIFICATIONS

FIND A RETAILER

BUILD YOUR OWN



ALL TERRAIN TECHNOLOGY

The Discovery not only looks truly at home in its surrounding, but also drives impeccably off-road. Its optimized geometry coupled with unique Land Rover technologies ensure it delivers exceptional all-terrain capabilities.

TERRAIN RESPONSE®

With over 65 years of all terrain expertise, this vehicle has Land Rover capability at its heart. Our proprietary Terrain Response® systems help the driver to optimize the vehicle's engine, transmission center differential and chassis systems to match the demands of the terrain, by selecting one of the easily identifiable driving modes. It also includes additional Rock Crawl Mode when your vehicle is equipped with electronic air suspension and two-speed transfer case*.

The optional Terrain Response® 2 system enhances this system even further by monitoring driving conditions and automatically selecting the driving modes to achieve the best possible chassis and powertrain set up for the conditions*.

ALL TERRAIN PROGRESS CONTROL

All Terrain Progress Control (ATPC) is an optional** system that enables drivers to set and maintain a steady speed in challenging conditions*.

Operating like a cruise control system, it functions at very low speeds between 1 mph and 18 mph, helping the driver to maintain concentration on steering and finding a path through obstacles.

Developed by Land Rover all-terrain specialists, the system works seamlessly alongside the Terrain Response® 2 and Four Wheel Drive (4WD) traction and braking systems*.

Once ATPC is activated, the standard steering wheel +/- cruise control buttons are used to set the speed. Brake and accelerator pedals can still override the chosen settings, with gentle braking achieving a reduction in speed.

 General Driving

 Sand

 Grass, Gravel, Snow

 Rock Crawl

 Mud & Ruts

*These systems are not a substitute for driving safely with due care and attention and will not function under all circumstances, speeds, weather and road conditions, etc. Driver should not assume that these systems will correct errors of judgment in driving.
**Not available on SE.

Features and their availability may differ by vehicle. Please see pages 86-99, or contact your nearest Land Rover Retailer, for more information.
Vehicle shown left is HSE Luxury in Namib Orange.



ABOVE & BEYOND

CONTENTS

SPECIFICATIONS

FIND A RETAILER

BUILD YOUR OWN



HILL DESCENT CONTROL (HDC®)

Land Rover's patented Hill Descent Control (HDC®) is a standard feature. It assists the driver with controlled descents of difficult slopes by maintaining a constant speed and applying braking separately to each wheel*.

Hill Start Assist is designed to help prevent the vehicle from rolling backwards as it pulls away on an incline*.

The vehicle also utilizes **Gradient Release Control (GRC)** which is designed to prevent the vehicle from accelerating too quickly on a steep incline when the driver releases the brake*.

*These systems are not a substitute for driving safely with due care and attention and will not function under all circumstances, speeds, weather and road conditions, etc. Driver should not assume that these systems will correct errors of judgment in driving.
Vehicle shown is HSE Luxury in Namib Orange.



ABOVE & BEYOND

CONTENTS

SPECIFICATIONS

FIND A RETAILER

BUILD YOUR OWN



PERMANENT FOUR WHEEL DRIVE (4WD) SYSTEMS



The Discovery features a choice of intelligent, permanent Land Rover Four Wheel Drive (4WD) systems* designed to deliver unrivalled capability. You can select from the following systems depending on capability requirements:

SINGLE SPEED TRANSFER CASE

This system has a single set of high range, road biased gears with the intelligence to sense wheel slip and move torque to the other axle to provide additional traction. It normally delivers 42 percent drive to the front axle with 58 percent drive biased to the rear axle. The center differential is reactive to wheel slip on one axle and can change the amount of bias to add more torque and traction to the other axle to support. This system is standard on SE and HSE.

TWO-SPEED TRANSFER CASE

A low range gear set can prove invaluable in challenging conditions such as steep inclines or declines, off-road driving or when towing. This system gives you precise speed and control in such instances. The heart of the two-speed system is the electronic center differential that offers a 50:50 torque split between front and rear axles with the ability to pre-emptively lock the axles before slip commences. Available as a combined option on SE and HSE and standard on HSE Luxury.

ACTIVE REAR LOCKING DIFFERENTIAL

The Active Rear Locking Differential – an option** when the vehicle has air suspension and two speed transfer case – offers an additional benefit of controlling the slip between the left and right wheels on the rear axle. This can be especially useful in low grip conditions such as on wet grass where the vehicle monitors the slip and torque between front and rear axles and also from one wheel to another on the rear axle to deliver effortless capability.

*These systems are not a substitute for driving safely with due care and attention and will not function under all circumstances, speeds, weather and road conditions, etc. Driver should not assume that these systems will correct errors of judgment in driving. **Not available on SE. Please consult the owner's manual or your local authorized Land Rover Retailer for more details.

Features and their availability may differ by vehicle specification. Please see pages 86-99, or contact your nearest Land Rover Retailer, for more information.

Vehicle shown left is HSE Luxury in Namib Orange.

SUSPENSION

COIL SUSPENSION

Standard on the SE and HSE, Discovery has a fully independent coil sprung suspension system that combines double wishbones at the front with an advanced multi-link rear suspension design to create an agile and responsive chassis.

Ride comfort and stability when heavily laden are optimized through the use of additional secondary springs incorporated within the rear suspension.

ELECTRONIC AIR SUSPENSION

A sure-footed, composed drive is completed by the latest four-corner air suspension which provides exceptional wheel articulation and poise.

Capable of taking on tough situations, this system is designed to keep the Discovery composed even on rough terrain. For unprecedented ride quality, it switches heights seamlessly when necessary.

Air suspension also allows for innovative new access features to enhance versatility and ease of use.

Automatic Access Height is a feature which automatically lowers the ride height by 1.6" when the vehicle is parked.

Rear Height Adjust allows the use of switches in the cargo space or on the key fob to lower the rear ride height. See page 56 for more information.

Available as a combined option on SE and HSE with two-speed transfer case and standard on HSE Luxury.



ABOVE & BEYOND

CONTENTS

SPECIFICATIONS

FIND A RETAILER

BUILD YOUR OWN



EFFICIENT TECHNOLOGIES

SUSTAINABLE CONSTRUCTION

The aluminum alloy used for much of the Discovery construction is from a high level of recycled aluminum. Using significantly less energy than primary aluminum to produce, it minimizes the vehicle's environmental impact.

STOP/START

Discovery engines are all available with Stop/Start. This system shuts down the engine when you come to a complete stop and restarts the engine immediately when required.

LIGHTWEIGHT MATERIALS

At every stage of the development process, engineers maximized weight saving across all the vehicle's elements. This produces an optimum balance between performance and weight saving for greater efficiency. The Discovery adopts an advanced all-aluminum body structure, delivering significantly reduced weight, improved performance and enhanced sustainability. Its tailgate is made from a lightweight plastic composite material which is also very stiff and strong, while high-precision lightweight magnesium castings are used for some of the body and chassis components.

DIESEL EXHAUST FLUID SYSTEM

Diesel models are equipped with a Diesel Fluid Exhaust (DEF) system to help clean exhaust gases. DEF is a non-toxic, non-flammable, biodegradable liquid that cleanses the gases in the vehicle's exhaust system to reduce harmful nitrogen oxide emissions.

LOW FRICTION TECHNOLOGIES

The Discovery gas and diesel engine range uses smart coating technologies on pistons, needle roller bearings and other mechanical parts. This helps to reduce friction, especially at low engine temperatures, so the vehicle performs at its peak efficiency.

ADVANCED AERODYNAMICS

The modern streamlined design has been carefully optimized using advanced Computational Fluid Dynamics software and a wind tunnel. This has led to an improvement of up to 15 percent drag reduction when compared to its predecessor while still maintaining stadium seating and two additional seats in the optional third row. An enhanced rear spoiler has been designed with slots to direct airflow over the tailgate to minimize rear window soiling and produce a reduction in drag.

Vehicles equipped with electronic air suspension benefit from speed lowering where the vehicle automatically lowers by 0.5" to reduce drag when cruising at highway speeds.

Vehicle shown left is HSE Luxury in Silicon Silver.



ABOVE & BEYOND

CONTENTS

SPECIFICATIONS

FIND A RETAILER

BUILD YOUR OWN



ON-ROAD DYNAMICS

The Discovery has been designed to deliver a confident, comfortable and engaging driving experience to make the miles go by virtually unnoticed.

With its wide-spaced double-wishbone design at the front and advanced multi-link layout at the rear, the suspension delivers more responsive handling without compromising Land Rover's hallmark all-terrain capability.

Dynamic Stability Control (DSC) monitors the vehicle's dynamic behavior, and it is designed to intervene if the system determines that the vehicle is not responding according to the driver's inputs*.

The DSC system operates by reducing engine torque and/or applying the brakes on selected wheels to correct the vehicle's cornering attitude and in addition can counteract understeer or oversteer conditions effectively. This system is standard on all models.

The Discovery's sublime ride quality is heightened further by such features as Electronic Power Assisted Steering (EPAS), a variable ratio system and speed sensitive steering. Standard on all models, EPAS is integrated into driver and chassis systems, helping to reduce the engine load to aid efficiency and deliver a confident and intuitive drive*.

The variable ratio system has been tuned to provide ease of control, on or off-road, when driving in a straight line or when turning. Different gear ratios within the steering rack help to reduce steering sensitivity when driving straight, but enhances steering input when turning.

Speed sensitive steering increases the feel of the steering as your speed increases to give stability and a greater feel of confidence. It also assists you at lower speeds to aid maneuverability by lightening the required steering effort. This system is standard on all models.

*These systems are not a substitute for driving safely with due care and attention and will not function under all circumstances, speeds, weather and road conditions, etc. Driver should not assume that these systems will correct errors of judgment in driving. Please consult the owner's manual or your local authorized Land Rover Retailer for more details.



DESIGN

DRIVING CAPABILITY

DRIVING TECHNOLOGY

COMFORT FOR ALL

ENGINES

BODY AND CHASSIS

SAFETY

ENVIRONMENTAL



ABOVE & BEYOND

CONTENTS

SPECIFICATIONS

FIND A RETAILER

BUILD YOUR OWN



TECHNOLOGY

INFOTAINMENT

Unique to Land Rover, the Land Rover InControl® infotainment system, the Touch Pro not only looks like no other, it performs like no other. Delivering a wealth of information and entertainment, it features intuitive and advanced integrated technologies to ensure everyone can make the most of their trip^Δ.

Search 'Discovery Infotainment System' for more details.



TOUCH PRO

Touch Pro is our state-of-the-art infotainment system that connects you to your world, delivers a plethora of entertainment options and puts all the information in one place.



INTERACTIVE DRIVER DISPLAY

The Discovery ensures you're always entertained, informed and connected. It features a 12.3" high-definition Interactive Driver Display* that can receive and project a vast amount of driving information, entertainment and data including navigation, phone and media. Its high resolution ensures the utmost clarity and its refined processing engine delivers smooth moving pin sharp graphics.



HEAD-UP DISPLAY**

Without distraction or the need for you to take your eyes off the road, our enhanced next generation Head-up Display** is an option on HSE and HSE Luxury that presents key vehicle data such as your speed, gear position and navigation directions on the windshield in the most innovative way^Δ. It features crystal clear full-color graphics in high resolution, enabling you to see all driver inputs and information with ease. It can display important information from the Touch Pro Touchscreen including phone and media information such as the name of the track you are listening to, as well as information and guidance for off-road driving via the All Terrain Info Center^Δ. The feature can be turned on and off dependent on driver preference.



REAR SEAT ENTERTAINMENT

The Rear Seat Entertainment[†] System provides two 8" screens built in to the rear of the front headrests. It includes 'Trip Status', a Navigation Summary screen which displays a pop-up for the rear occupant detailing the time and distance to destination. The system comes with a pair of WhiteFire[®] digital wireless headphones and HDMI, Mobile High-Definition Link (MHL) and USB connections.

*Standard on HSE and HSE Luxury. Optional on SE. **Requires infrared reflective glass. †Optional on HSE and HSE Luxury. ‡These systems are not a substitute for driving safely with due care and attention and will not function under all circumstances, speeds, weather and road conditions, etc. Driver should not assume that these systems will correct errors of judgment in driving. Please consult the owner's manual or your local authorized Land Rover Retailer for more details. †Driving while distracted can result in loss of vehicle control. Do not operate, adjust or view the navigation or multimedia systems under conditions that will affect your safety or the safety of others. Only use mobile phones and other devices, even with voice commands, when it is safe to do so.

Interior shown left and above is HSE Luxury in Light Oyster/Espresso.



ABOVE & BEYOND

CONTENTS

SPECIFICATIONS

FIND A RETAILER

BUILD YOUR OWN

AUDIO

A vehicle's cabin is the ideal place within which to experience your personal choice of music and Discovery has the option of three different audio systems to bring your music to life:

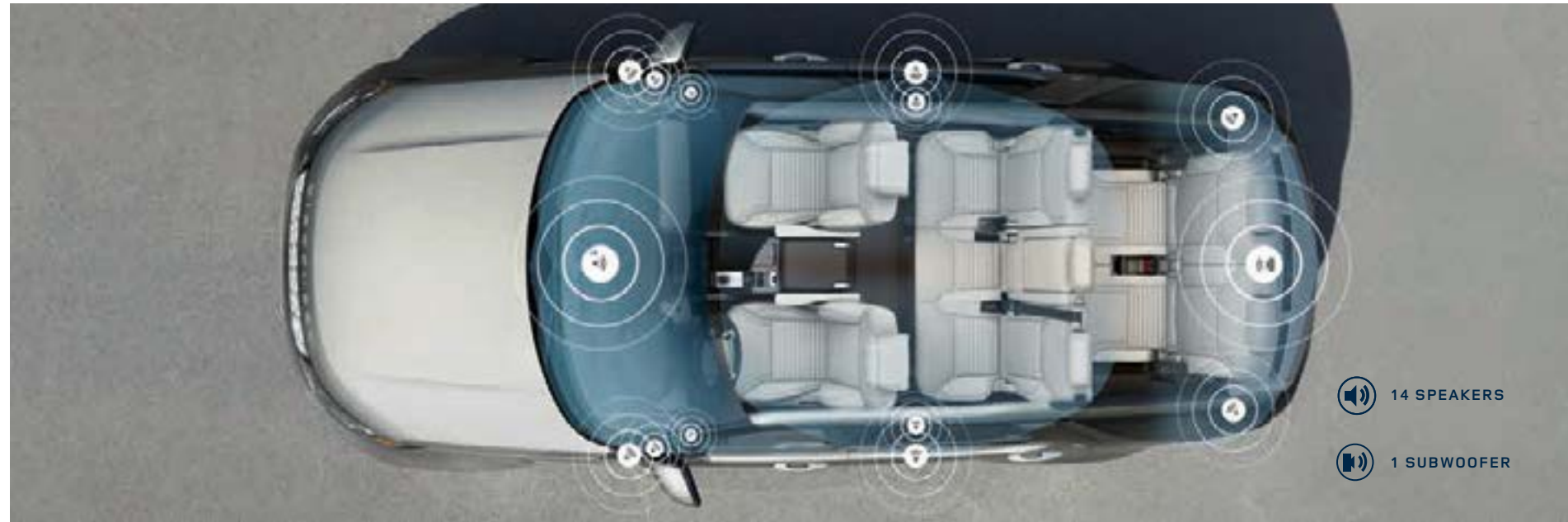

ENHANCED SOUND SYSTEM

The Land Rover 250W Enhanced Sound System features 10 speakers and is standard on SE models.

MERIDIAN™ SOUND SYSTEM

Great definition, crystal clear highs and full, deep bass – delivered through this 380W system's careful arrangement of 10 speakers plus a dual channel subwoofer. It is standard on HSE and available as an optional upgrade on SE models.

MERIDIAN SURROUND SOUND SYSTEM

All the fullness and clarity of a live performance delivered through an arrangement of this 825W system's 14 front, side and rear speakers plus a dual channel subwoofer – seamlessly brought together using Meridian Trifield™ technology and exclusive to Meridian, Trifield perfectly blends the center and surround channels with left and right channels ensuring an optimum, consistent sound experience for each passenger. It is standard on HSE Luxury models and available as an optional upgrade on HSE models.

SIRIUSXM® SATELLITE RADIO AND HD RADIO™

The HD satellite radio technology offers improved sound quality, and a wide choice of stations and entertainment*. Standard on HSE and HSE Luxury and available as an option on SE.

MERIDIAN

Formed in 1977 in Cambridgeshire, England, Land Rover's audio partner Meridian has pioneered many firsts including active speakers and the world's first digital surround sound processor.

Meridian's audio technology input has helped ensure that the Discovery is one of the most superb spaces within which to experience sound. Meridian Cabin Correction technology was utilized to analyze cabin shape, acoustics and resonance characteristics in order to help remove unwanted sounds.

The advanced algorithm ensures that the rhythm, punch and timing of any piece of music are heard precisely how the artist intended, providing a consistently exceptional quality audio experience for all passengers in the vehicle.



DIGITAL SIGNAL PROCESSING

Brings all elements of the audio system together as one, for performance that would otherwise require significantly larger speakers.



MERIDIAN CABIN CORRECTION

The advanced algorithm of Meridian's Cabin Correction tailors the sound experience to the precise acoustics of the Discovery interior.



MERIDIAN DIGITAL DITHER SHAPING

To maintain the quality of musical recordings, they are converted into a common digital format. Meridian Digital Dither Shaping ensures that digital signal conversions are made smoothly and seamlessly, preserving the finest details of the audio performance. The result is authentic musical conversion, evoking the emotions of the original recording.



TRIFIELD

Exclusive to Meridian, Trifield blends the center and surround channels seamlessly with left and right channels, delivering a consistent, concert-like experience for all occupants.

	UNIQUE MERIDIAN TECHNOLOGY	SPEAKERS	DUAL-CHANNEL SUBWOOFER	WATTS
ENHANCED SOUND SYSTEM	N/A	10	N/A	250
MERIDIAN SOUND SYSTEM		10	1	380
MERIDIAN SURROUND SOUND SYSTEM		14	1	825

*A 3-month trial subscription to the SiriusXM All Access package is included with the vehicle, which gives you access to 150+ channels of premium programming. Plus you can stream SiriusXM on your computer, smartphone or tablet – it's included in your trial. If you decide to continue service after your trial, the subscription plan you choose will automatically renew thereafter and you will be charged according to your chosen payment method at then-current rates. Fees and taxes apply. To cancel you must call SiriusXM at 1-866-635-2349. See the 22 SiriusXM Customer Agreement for complete terms at siriusxm.com. All fees and programming are subject to change. SiriusXM Satellite Radio is not available in Alaska or Hawaii.

42 Interior shown with Meridian™ Surround Sound System 825W with 14 speakers including a dual channel subwoofer.

Meridian is a trademark of Meridian Audio Ltd. Trifield and the "three fields" device is a trademark of Trifield Productions Ltd.



ABOVE & BEYOND



CONNECTIVITY

Land Rover InControl® is the suite of standard and optional features that connects you to your vehicle and links you seamlessly, with the outside world. With a selection of apps, even when you're away from your vehicle, some of the InControl features stay with you, making sure the Land Rover experience is more enjoyable than ever*.

Search 'InControl' for more details.

*Do not use Land Rover InControl® features under conditions that will affect your safety or the safety of others. Driving while distracted can result in loss of vehicle control. Vehicle shown above and right is HSE Luxury in Namib Orange.

CONTENTS

SPECIFICATIONS

FIND A RETAILER

BUILD YOUR OWN

STANDARD FEATURES

VOICE RECOGNITION SYSTEM

Understands clear spoken instructions, so you can concentrate on the road ahead without distractions**.

NAVIGATION PRO*

Fitted as standard on SE, HSE and HSE Luxury, Navigation Pro allows you to save your favorite places, use pinch and zoom gestures for simple map exploration and can display a choice of either 2D or 3D crystal clear map graphics.

CONNECT PRO PACKAGE*

Connect Pro consists of 4G Wi-Fi Hotspot¹, and Pro Services, and is designed to enhance your in-car and out-of-car experience, ensuring you and your passengers enjoy the journey while remaining connected to the world.

Pro Services include:

- **Real Time Traffic Information** – Uses live traffic data feeds to give you the most accurate picture of what the traffic is like on the way to your destination.
- **Online Search** – Wherever you are, you can search the surrounding area for places of interest. The system can access expert destination information, travel tips and inspiration as well as online travel reviews of the local area.
- **Planning Routes and Door-to-Door Routing** – Before setting off, use the optional Route Planner app or online to search, save locations or set your destination. The app uses the Cloud to send your destination automatically to your vehicle's navigation screen. Once you've parked, the Route Planner app will guide you to your destination – a true door-to-door experience which includes public transportation options.
- **Share ETA** – You can share your estimated time of arrival so your selected contact(s) will know exactly when you will arrive, as calculated by the navigation guidance system. If you're running late, Share ETA can then send automatic updates via text messages or email, without any further action from you.
- **Satellite View** – There may be times when you want to get the context of your surroundings from overhead. With Connect Pro you can switch to satellite view with a single tap.
- **Street Level Imagery** – To help you recognize your destination as you approach it, the screen can display a 360 degree panoramic street level image.

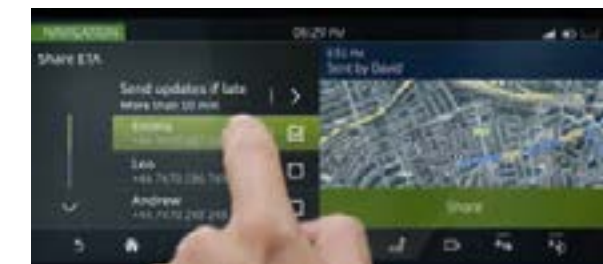
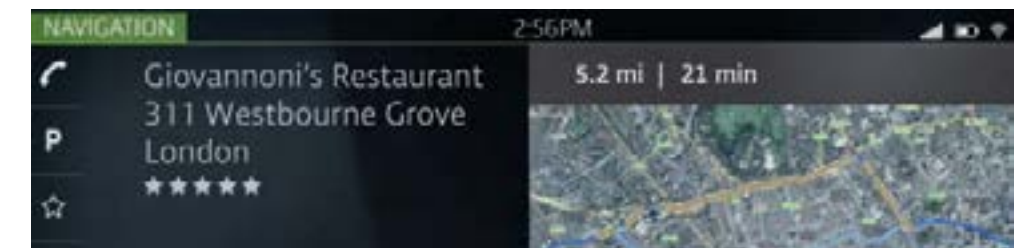

**Driving while distracted can result in loss of vehicle control. Do not operate, adjust or view the navigation or multimedia systems under conditions that will affect your safety or the safety of others. Only use mobile phones and other devices, even with voice commands, when it is safe to do so. ¹Wi-Fi Hotspot is intended for passenger use only. InControl features may require an additional subscription with separate terms and conditions.

DESIGN

DRIVING CAPABILITY

DRIVING TECHNOLOGY

COMFORT FOR ALL

ENGINES

BODY AND CHASSIS

SAFETY

ENVIRONMENTAL



ABOVE & BEYOND

CONTENTS

SPECIFICATIONS

FIND A RETAILER

BUILD YOUR OWN

STANDARD FEATURES CONTINUED

CONNECT PRO PACKAGE* CONTINUED

- **Fuel Prices** – This service not only finds gas stations along your route, it also enables you to compare fuel prices so you can keep your costs down.
- **Commute Mode** – Allows the system to learn your commutes and automatically advises you of the expected travel time based on live and historical traffic movements without you having to input a destination. The system learns the routes you take for a given destination and then advises which of those is the quickest.
- **Parking Service** – As you approach your destination, you can see where parking is available. Simply tap on your preferred parking and the navigation system updates to direct you to it.
- **Online Routing** – While you're on your way to a destination the system monitors live traffic conditions and takes into account typical traffic patterns for that time of day, keeping you on the optimum route.

Remote app provides upgraded information on your vehicle and enables you to interact with it remotely. Compatible with most smartphones, Android™ Wear or the Apple Watch®, this service includes:

- **Remote Lock/Unlock** – Lock or unlock your doors remotely with the click of a button.
- **Remote Climate** – Prepare your Land Rover in advance by pre-heating or pre-cooling the cabin, so that you and your passengers are comfortable from the moment you step inside.
- **Beep/Flash** – This feature turns on your Land Rover's hazard lights, flashes headlights and sounds an audible alert to help you locate your vehicle.
- **Journey Tracking** – This opt-in feature can automatically record your journey history including your route and mileage statistics. This information can be exported by email to use for expense reporting.
- **Vehicles Status Check** – Check current fuel level and range, and status of door and window position and locks. See the last parked location of the vehicle and find your way back to it with on-foot directions.

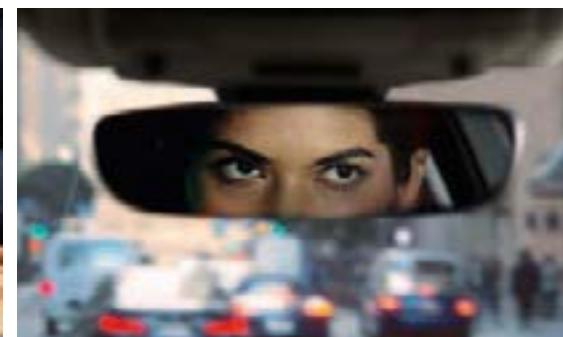
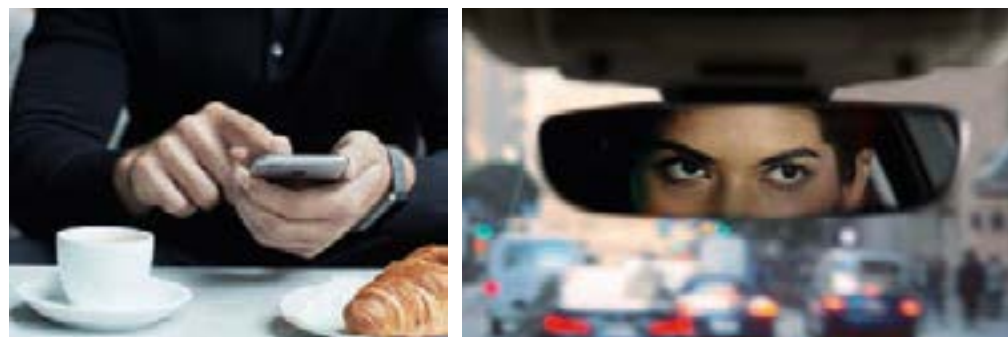

CONNECT PRO PACKAGE* CONTINUED

InControl Apps™ technology allows vehicle-optimized apps on your Android or Apple smartphone to be controlled through the vehicle's Touchscreen, including contacts, calendar and music player via a USB cable to the USB slot. You can also download third-party apps offering a vast range of services†. Applications include:

- **Spotify**** – Access a library of more than 30 million songs with this seamlessly integrated app – the first true in-car, Spotify experience. Featuring all the same intuitive functionality as the Spotify smartphone app, you can search songs, stations and recommendations, create playlists and access your music in offline mode.
- **Tile††** – Helps you find lost or misplaced items in seconds. Attach a tiny Bluetooth® tracker Tile to your keys, wallet or bag. The easy-to-use Tile app can then help you find these items should they be misplaced. The app is accessible any time through your vehicle's Touchscreen, allowing you to make sure you have everything you need with you, before you set off on your journey.

PROTECT

Land Rover Optimized Assistance – If you break down you can make a direct call to the Land Rover Assistance team by pressing the button on the overhead console or from the Assistance screen within the InControl Remote smartphone app.



*Driving while distracted can result in loss of vehicle control. Do not operate, adjust or view the navigation or multimedia systems under conditions that will affect your safety or the safety of others. Only use mobile phones and other devices, even with voice commands, when it is safe to do so.

**Only available on Apple smartphones. Not available on Android smartphones. †Do not use Land Rover InControl® features under conditions that will affect your safety or the safety of others. Driving while distracted can result in loss of vehicle control. ††Requires InControl Apps ©2017 Tile Inc. Tile and the Tile design are trademarks of Tile, Inc.



ABOVE & BEYOND

CONTENTS

SPECIFICATIONS

FIND A RETAILER

BUILD YOUR OWN



INTERIOR ELECTRICAL OUTLETS

The Discovery is packed with the latest innovative technologies and USB charging points are available for all three rows of seats. So no matter where they sit, every single passenger can stay entertained; whether on their tablets, mobile phones or other devices*.

It includes a 12V port in the upper glovebox, one in the instrument panel, a USB port in the center console, one 12V and two USB ports in the cubby box, two 12V or USB ports in rear center console, two USB ports in the row three storage, one 12V in the luggage compartment, and two additional USB ports when Rear Seat Entertainment is fitted.

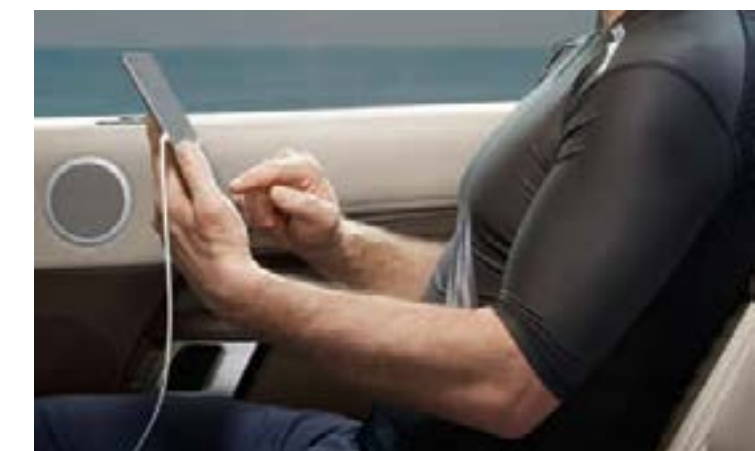

*Fitment of USB ports and 12V locations varies by trim level. Interior shown is HSE Luxury in Light Oyster/Espresso.



ABOVE & BEYOND

CONTENTS

SPECIFICATIONS

FIND A RETAILER

BUILD YOUR OWN

DRIVING TECHNOLOGY

DRIVER ASSISTANCE

MAKING DRIVING EASIER

From negotiating city traffic or the highway, to providing additional safety for you and your passengers, there's a wealth of innovative technologies available; either as standard, optional or as part of an optional package. Whichever you choose, you'll find every single feature has been designed and engineered to heighten your enjoyment of the vehicle.

Search 'Discovery Driver Assist' for more details.

STANDARD DRIVE FEATURES



Cruise Control with Speed Limiter

Cruise Control with Speed Limiter allows the driver to maintain the current speed of the vehicle without the need for continued use of the accelerator pedal, making driving easier and more enjoyable. The Speed Limiter will also allow the driver to pre-set a maximum specified speed which the vehicle will not exceed. Both functions can be easily turned on or off by the driver as desired*.

Emergency Braking can help to prevent foreseeable collisions with other vehicles or pedestrians. If a potential frontal collision is detected, a warning is displayed giving you time to take action. A camera at the front of the vehicle monitors at speeds from 3 to 50 mph for frontal collisions and 3 to 37 mph** for pedestrians. If a collision is still anticipated and you have taken no action, this system will apply the brakes to help reduce the severity of the possible impact*.

OPTIONAL DRIVE FEATURES



Lane Departure Warning

Adaptive Cruise Control with Queue Assist and Intelligent Emergency Braking system works when you're cruising on the highway or travelling in slow-moving traffic, it is designed to keep your vehicle a set distance from the one in front should it slow or stop. Should the vehicle in front stop completely, your vehicle is designed to come to a smooth stop. Once the traffic moves, simply touch the accelerator and Adaptive Cruise Control will resume following the vehicle in front. The system can be activated from 10 mph up to highway speeds*.

If a collision is unavoidable, Adaptive Cruise Control will engage Intelligent Emergency Braking. This system is designed to help reduce injuries and damage by automatically applying the brakes*.

Lane Departure Warning can help make long trips more enjoyable. The system senses when your vehicle is unintentionally drifting out of your lane, and notifies you with a visual alert and a gentle vibration of the steering wheel*.

OPTIONAL DRIVE PACKAGE†



Traffic Sign Recognition with Adaptive Speed Limiter

The optional Drive Package offers a range of features that help keep you informed.

The Drive Package includes:

Driver Condition Monitor is designed to detect if you're starting to feel drowsy and gives you an early warning when you need to take a break*.

Blind Spot Monitor and Reverse Traffic Detection is designed to alert you to vehicles in, or quickly approaching your blind spot. When a vehicle is detected, a small warning light will illuminate in the corresponding side mirror. If you indicate in the direction of the obstacle, the warning light will flash to highlight potential danger. Reverse Traffic Detection will also alert you with both audio and visual warnings so you know what's behind you even when the view is obstructed*.

Traffic Sign Recognition and Adaptive Speed Limiter keeps you informed and aware on the road, by displaying speed limits and no passing signs in the instrument cluster, where they can easily be seen. When activated, **Adaptive Speed Limiter** uses Traffic Sign Recognition information to adjust your vehicle's speed accordingly*.

OPTIONAL DRIVE PRO PACKAGE‡



Blind Spot Assist

Making every trip more relaxing. The optional Drive Pro Package contains all the technologies within the Drive Package, plus the following enhancements:

Lane Keep Assist† is designed to detect when your vehicle is unintentionally drifting out of your lane, and to gently steer you back*.

Blind Spot Assist is designed to help prevent foreseeable collisions. If your vehicle detects another car in your blind spot when you begin to change lanes, this system provides precisely calculated steering torque – guiding your vehicle away from the approaching car.

Adaptive Cruise Control with Queue Assist and Intelligent Emergency Braking – See page 50 for description.

*These systems are not a substitute for driving safely with due care and attention and will not function under all circumstances, speeds, weather and road conditions, etc. Driver should not assume that these systems will correct errors of judgment in driving. Please consult the owner's manual or your local authorized Land Rover Retailer for more details. **Always follow local speed limits.

†Available on Discovery models when auto-dimming exterior mirrors are fitted. ‡Not available on SE models.



ABOVE & BEYOND

CONTENTS

SPECIFICATIONS

FIND A RETAILER

BUILD YOUR OWN

ENJOY STRESS-FREE PARKING

The Discovery offers the most advanced technologies to deliver intuitive and easy parking solutions. Whether reversing, parallel parking or getting into or out of tight spaces, these features make life easier. Available as standard, optional or as part of an optional package.

Search 'Discovery Parking Assist' for more details.

PARK FEATURES



Rear Parking Aid

Rear Parking Aid* helps make reversing into tight spaces easier. When you select Reverse, sensors located in the rear bumper are automatically triggered. As you park, the Touchscreen display and audio feedback indicates how close you are to obstacles¹.

CAMERAS



Surround Camera System

Rear View Camera* provides improved visibility when reversing. This valuable parking aid also helps when hitching a trailer. Static lines representing the vehicle's outer perimeter and predicted path are superimposed on the rearward image, designed to make parking in tight spots as easy as possible¹.

Surround Camera System** uses four digital cameras discretely placed around the vehicle, providing a 360° overhead view on the Touchscreen. With the capacity to display several different views at the same time, this helps with various maneuvers from parking by a curb, to getting in and out of tight spaces and intersections¹.

PARKING AIDS



360° Parking Aid

Front[‡] and Rear Parking Aid* helps make maneuvering even easier. When you select Reverse, or choose to activate them manually, sensors located in the front and rear bumpers are triggered. As you park, the Touchscreen display and audio feedback indicates how close you are to obstacles¹.

360° Parking Aid^Δ gives you confidence when maneuvering in tight spaces. Sensors located around the vehicle are automatically triggered when Reverse is selected, or can be manually activated, with a graphic appearing on the Touchscreen showing an overhead view of the vehicle. As you park, the Touchscreen display and audio feedback indicates how close you are to obstacles¹.

PARK ASSIST



Park Assist

Park Assist^Δ (includes 360° Parking Aid) makes parallel and perpendicular parking easier than ever by steering your vehicle into a suitable space. You just have to select the appropriate gear and control the vehicle's speed with the brake and accelerator pedals. Graphics and notifications guide you through the maneuvers. Park Assist will also steer you out of a space[§], taking the stress out of parking¹.

*Standard on SE, HSE and HSE Luxury. **Optional on HSE and HSE Luxury as part of the Vision Assist Package. Not available on SE. ¹These systems are not a substitute for driving safely with due care and attention and will not function under all circumstances, speeds, weather and road conditions, etc. Driver should not assume that these systems will correct errors of judgment in driving. Please consult the owner's manual or your local authorized Land Rover Retailer for more details.

[‡]Optional on SE and standard on HSE and HSE Luxury. ^ΔOptional on SE, HSE and HSE Luxury. [§]Park Assist is only programmed to steer you out of a parallel parking space. Park Assist is not designed to steer out of a perpendicular parking space.



ABOVE & BEYOND

CONTENTS

SPECIFICATIONS

FIND A RETAILER

BUILD YOUR OWN

DRIVING AIDS



LOW TRACTION LAUNCH*

The Discovery features a dedicated launch function, which is designed to assist launching on tricky low-friction surfaces like snow or wet grass. The software adapts the system's behavior according to the current Terrain Response® setting. When you pull away, you do so with composure and greater ease.

ALL TERRAIN INFO CENTER



The All Terrain Info Center** within your navigation system allows you to view and activate various features and provides access to All Wheel Drive (AWD) information and guidance features for off-road driving*.

The Touchscreen† displays information about the vehicle's wheels, suspension, transmission and driveline including suspension movements and articulation for vehicles with electronic air suspension.

The system can show the angle and pitch of the vehicle on slopes and inclines, and includes a useful compass together with current latitude, longitude and altitude details.

The Info Center provides a host of other helpful guidance such as vehicle dimensions, useful for entering tighter spots and can be used to activate additional capability features, such as Low Traction Launch*.

Using the optional Surround Camera System**††, the Info Center can also show the area directly ahead of the vehicle that may not be visible to the driver to help ensure the vehicle isn't damaged on unseen terrain.

*These systems are not a substitute for driving safely with due care and attention and will not function under all circumstances, speeds, weather and road conditions, etc. Driver should not assume that these systems will correct errors of judgment in driving. **The number of features displayed on the All Terrain Info Center is dependent upon the specification of the vehicle. †Driving while distracted can result in loss of vehicle control. Do not operate, adjust or view the navigation or multimedia systems under conditions that will affect your safety or the safety of others. Only use mobile phones and other devices, even with voice commands, when it is safe to do so. ††Not available on SE. Interior shown above is the HSE Luxury in Light Oyster/Espresso.



ABOVE & BEYOND

CONTENTS

SPECIFICATIONS

FIND A RETAILER

BUILD YOUR OWN

TOWING AIDS

The Discovery takes towing capability to a new level, with a capacity of up to 8,201 lbs* and a suite of features available to help make towing effortless and assured.

1 TOW HITCH ASSIST

Tow Hitch Assist** makes coupling a trailer to the vehicle much easier by helping you visualize the hitching process; it displays the predicted path of the vehicle tow ball towards the trailer coupler on the Touchscreen. Standard with Surround Camera System.

2 REAR HEIGHT ADJUST

Rear Height Adjust allows the use of switches in the cargo space or on the key fob to lower the rear ride height – useful when loading or unloading cumbersome items, or when hitching, unhitching or loading a trailer. This feature is included with electronic air suspension.

3 TOW ASSIST

On the road, the Tow Assist feature helps with reversing by predicting the trailer's direction**. You can even choose your trailer's width for precise guidelines displayed on the Touchscreen. Standard with Surround Camera System.



*Towing capacity on Si6 engine only. Towing capacity for Td6 engine is 7,716 lbs. **These systems are not a substitute for driving safely with due care and attention and will not function under all circumstances, speeds, weather and road conditions, etc. Driver should not assume that these systems will correct errors of judgment in driving. Please ensure you comply with relevant legislation in the USA. Vehicle shown is HSE Luxury in Namib Orange.



ABOVE & BEYOND

CONTENTS

SPECIFICATIONS

FIND A RETAILER

BUILD YOUR OWN

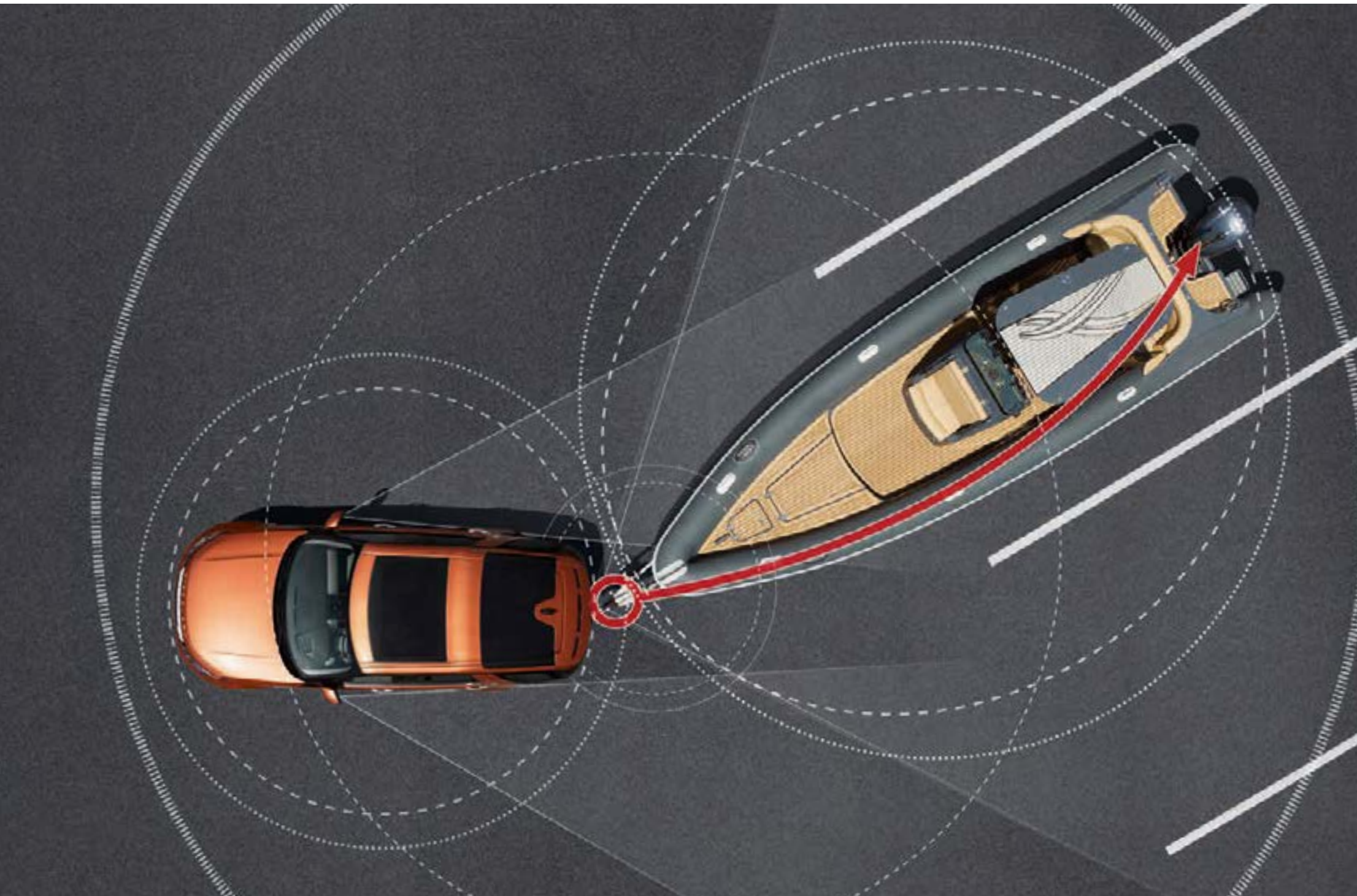

ADVANCED TOW ASSIST

The Discovery features our most advanced trailer reversing aid. Advanced Tow Assist* enables the driver to guide a trailer into position by simply following its trajectory on the main Touchscreen, and controlling its path using the rotary knob from the Terrain Response® 2 system on the center console*. This is much more intuitive than using the steering wheel because within one field of vision it effectively steers the trailer along the desired path. This is rather than the opposing direction method which is what happens with conventional steering.

In addition to significantly reducing driver workload, the feature enhances maneuverability when reversing, and will alert the driver when approaching a jack-knife situation.

Advanced Tow Assist is only available with Surround Camera, 360° Parking Aid and Terrain Response® 2*. A Land Rover approved tow hitch receiver is required in order to enable this feature.

SURROUND CAMERA SYSTEM*

For a complete, all-round view, the optional Surround Camera System*¹ incorporating Intersection View helps to see everything clearly on the high-resolution full-color Touchscreen. Using four digital cameras discreetly placed around the vehicle, the system provides an almost complete 360° view including a birds-eye overhead view. It is perfect for more complex driving assignments such as towing a sailboat or horse trailer. Along with the ability to display several different views at the same time, this technology can also zoom and pan, ensuring objects and angles, normally below the line of sight, can be seen*.

TRAILER STABILITY ASSIST

Trailer Stability Assist (TSA) monitors the vehicle to detect movements in the trailer and then uses selective braking to help correct potentially hazardous situations*.

*These systems are not a substitute for driving safely with due care and attention and will not function under all circumstances, speeds, weather and road conditions, etc. Driver should not assume that these systems will correct errors of judgment in driving. ¹Not available on SE. Please ensure you comply with relevant legislation in the USA. Vehicle shown is HSE Luxury in Namib Orange.



ABOVE & BEYOND

CONTENTS

SPECIFICATIONS

FIND A RETAILER

BUILD YOUR OWN



COMFORT FOR ALL

AUTOMATIC ACCESS HEIGHT

It's always good to arrive in style, so that's why we've introduced Automatic Access Height*. When you pull up at your chosen destination and the ignition is switched off or the seat belts are unclipped, the vehicle lowers by an initial 0.6". Then, as you open the door, it drops to its full access height of 1.6" lower, making exit – and entry – that much more relaxed and elegant. The ride height automatically returns to its normal height as you pull away.

GARAGE DOOR OPENER (HOMELINK®)

The HomeLink® system is a universal transmitter fitted to the underside of the interior rear view mirror. This transmitter can be programmed to operate up to three home or office wireless controlled systems, such as garage doors, automatic gates, or security lighting. By replacing the individual remote control units normally required for each system, the driver no longer needs to search the car interior for the correct remote when needed.

CABIN AIR IONIZATION

This technology ionizes particles in the air, making them attract to surfaces and thus helping to cleanse the air. It can be switched on or off.

*Standard with electronic air suspension.
Vehicle shown is HSE Luxury in Silicon Silver.



DESIGN

DRIVING CAPABILITY

DRIVING TECHNOLOGY

COMFORT FOR ALL

ENGINES

BODY AND CHASSIS

SAFETY

ENVIRONMENTAL



ABOVE & BEYOND

CONTENTS

SPECIFICATIONS

FIND A RETAILER

BUILD YOUR OWN



PANORAMIC ROOF

The full glass fixed* or front opening** panoramic sunroof enhances the sense of space in the vehicle's interior and floods it with natural light, benefiting the entire interior cabin, as well as providing enhanced views of the surrounding environment.

Importantly, the toughened glass has a dark tint to maintain a comfortable temperature inside the cabin and protect occupants and the interior from the sun's rays. Powered interior blinds are also provided for added comfort.

CONFIGURABLE AMBIENT INTERIOR LIGHTING

New levels of ambient refinement and personalization have been reached with Configurable Ambient Interior Lighting, standard on HSE Luxury.

This feature allows you to vary the color and brightness, changing the ambience of the cabin to suit your mood. There are five colors in total, ranging from Ice White through to Moon Light and Racing Red.

CLIMATE CONTROL

To ensure that the interior is maintained at the perfect temperature, whatever the weather outside, the Discovery features a highly efficient climate control system. The result of an incredibly rigorous development program, the system has been tested in real-world conditions in temperatures ranging from -40°F to +120°F.

Three versions are available, ranging from a Two-zone automatic system to a Four-zone automatic system. The Four-zone system is available as an option on HSE and HSE Luxury, which has separate climate controls for driver, front passenger and each side of the rear cabin.

With its independent heating and cooling capability, the Four-zone system offers a significant improvement in rear seat luxury, with multiple outlets at face and foot level.

SEATING

Heated front and second row outboard seats are available as part of a package on SE and HSE, standard on HSE Luxury. Optional heated third row seats are also available on HSE and HSE Luxury.

No matter the temperature, optional heated and cooled front and rear seats with heated third row seats are also available on HSE and HSE Luxury. This enables both the driver and passenger to set their preferred temperature independently and is controlled via the Touchscreen.

For the ultimate in comfort, optional massage front seats are available on HSE Luxury allowing both the driver and front passenger to select individual programs via the Touchscreen. Varying in intensity, there are five settings to choose from; each one delivers a soothing massage to improve both the driver and passenger's comfort.



*Standard on SE. **Standard on HSE and HSE Luxury. Optional on SE.

Features and their availability may differ by vehicle specification. Please see pages 88-99, or contact your nearest Land Rover Retailer, for more information.

Interior shown is HSE Luxury in Light Oyster/Espresso.

DESIGN

DRIVING CAPABILITY

DRIVING TECHNOLOGY

COMFORT FOR ALL

ENGINES

BODY AND CHASSIS

SAFETY

ENVIRONMENTAL



ABOVE & BEYOND

CONTENTS

SPECIFICATIONS

FIND A RETAILER

BUILD YOUR OWN



ACTIVITY KEY

The Activity Key makes living life to the fullest easier. For convenience, you can wear the Activity Key if you prefer not to carry a key fob. The wristband is robust and fully waterproof, allowing you to enjoy a range of activities – from sailing to skydiving – and keep your car key with you. The Activity Key has been tested in a number of extreme environments and is therefore capable in depths of up to 98 ft. of water and in temperatures ranging from -40°F to +185°F.

You can use the Activity Key to lock and unlock your vehicle. When exiting, you can secure the conventional key fob in the vehicle and hold the Activity Key to the tailgate to lock it. The conventional key fob is then automatically deactivated for security. The Activity Key can be ordered as an optional feature or as a Land Rover Retailer fit accessory.

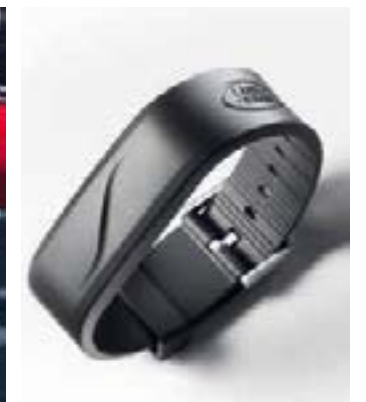

Vehicle shown left is HSE Luxury in Silicon Silver.

DESIGN

DRIVING CAPABILITY

DRIVING TECHNOLOGY

COMFORT FOR ALL

ENGINES

BODY AND CHASSIS

SAFETY

ENVIRONMENTAL



ABOVE & BEYOND

CONTENTS

SPECIFICATIONS

FIND A RETAILER

BUILD YOUR OWN



ENGINES

8-SPEED AUTOMATIC TRANSMISSION

Both engines are paired with the advanced electronically controlled 8-speed Automatic Transmission, which has been tuned to combine silky-smooth shifting with exceptionally rapid response. With eight closely spaced ratios, gear changes are almost imperceptible, with each shift completed in just 200 milliseconds.

Controls include steering wheel-mounted paddle shifters, enabling the driver to take control of gear shifting manually.

The optimized lightweight 8-speed Automatic Transmission is the perfect partner to the torque-rich engines.

The transmission is tuned to select torque converter lock-up as early as possible to reduce slip and energy loss. Transmission Idle Control disengages 70 percent of the drive when the vehicle is stationary and the engine is idling in Drive, significantly reducing fuel consumption in urban conditions.

In cold conditions, the transmission selects a lower gear to promote fast warm up and get the engine up to its efficient operating temperature as soon as possible.

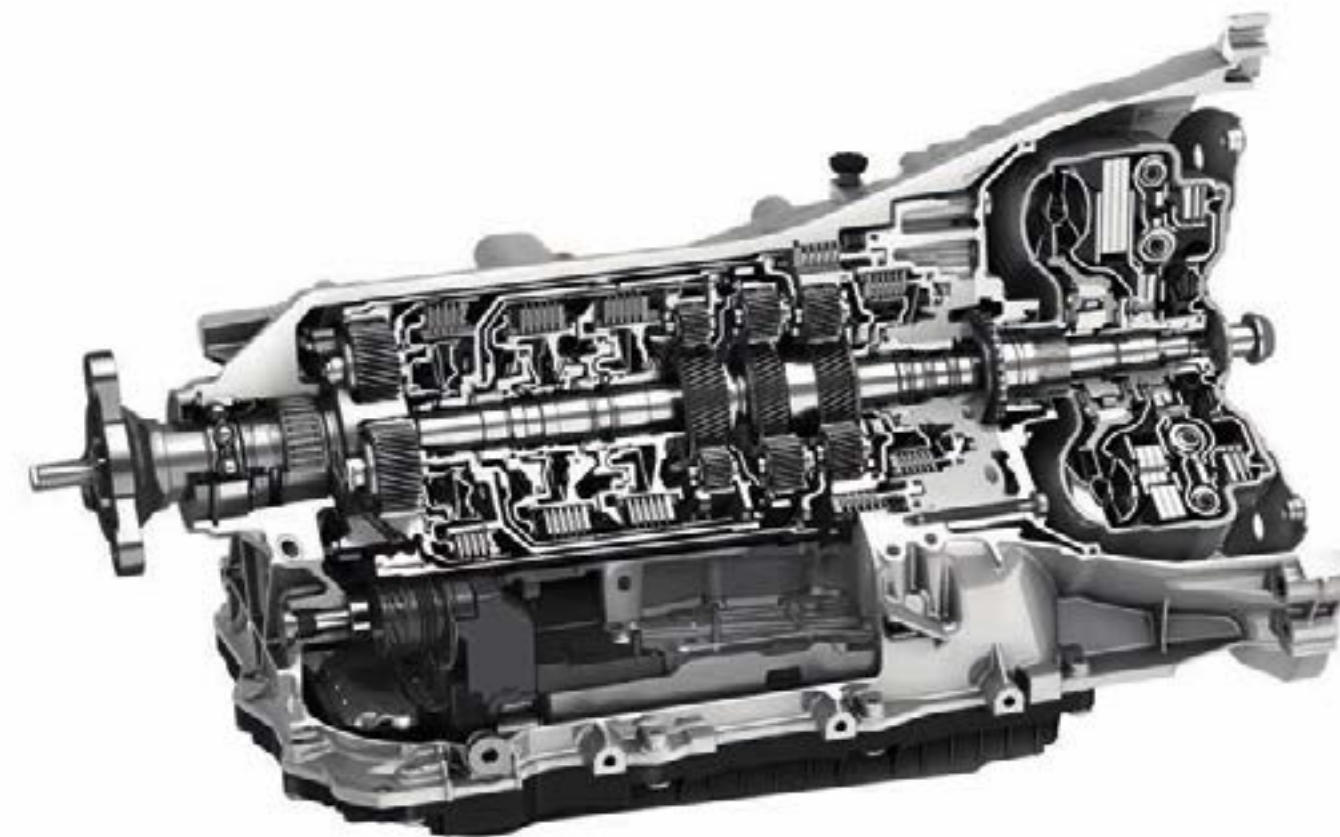

Vehicle shown left is HSE Luxury in Namib Orange.



ABOVE & BEYOND

CONTENTS

SPECIFICATIONS

FIND A RETAILER

BUILD YOUR OWN



GAS ENGINE

Si6 340HP

A Roots-type twin vortex supercharger is mounted in the 'V' between the two rows of cylinders for compact dimensions. Supercharging provides linear delivery of power and optimizes responsiveness.

The V6 engine also features dual independent variable cam timing to vary inlet and exhaust valve operation, working alongside lightweight pistons with ultra-low friction piston rings, for increased performance. For added refinement there is a counter-rotating balancer shaft system.

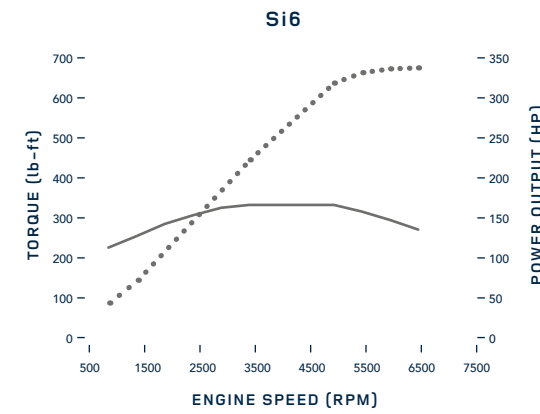

— Torque (lb-ft)
..... Power (HP)



DIESEL ENGINE

Td6 254HP

The Land Rover Discovery features an available 3.0 liter Turbocharged Diesel engine. Its design utilizes a single turbocharger and ceramic ball bearing technology to reduce friction for smooth, more immediate delivery of power at all engine speeds.

The engine uses an eight-nozzle low-flow injector designed for more precise injection and improved fuel atomization. Delivering substantial maximum torque of 443 lb-ft, the Td6 is capable of refined and smooth responsive performance.

The intake system with twin intercoolers ensures charge cooling. The engine also features the latest tandem solenoid intelligent Stop/Start system to reduce fuel consumption.

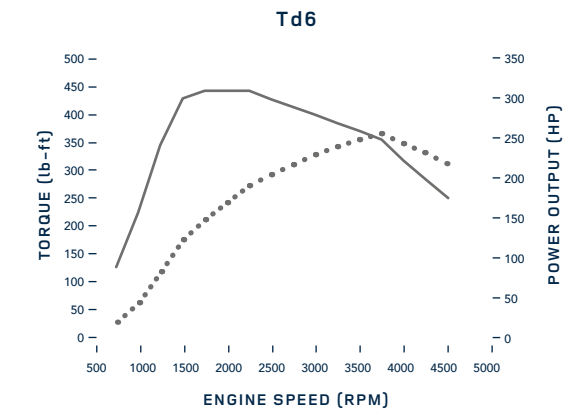

— Torque (lb-ft)
..... Power (HP)



ACCELERATION
0-60 MPH* (SECONDS)

3.0L Si6 Gas 340HP

6.9



TOP SPEED
(MPH)*

130

CC

CAPACITY
(CC)

2,995



ACCELERATION
0-60MPH* (SECONDS)

3.0L Td6 Diesel 254HP

7.7



TOP SPEED
(MPH)*

130

CC

CAPACITY
(CC)

2,993



ABOVE & BEYOND

CONTENTS

SPECIFICATIONS

FIND A RETAILER

BUILD YOUR OWN

BODY AND CHASSIS

STRENGTH AND STABILITY

HIGH STRENGTH ALUMINUM CONSTRUCTION

With an advanced aluminum unibody, the Discovery enjoys greater levels of performance, together with improved strength and sustainability. It is nearly 1,000 lbs lighter than its predecessor*. Added to which, thanks to utilizing the latest in materials and build technologies, the vehicle can readily take the rugged use associated with off-road driving.

RUGGED SUSPENSION ARCHITECTURE

Another key factor in the driving capability of the Discovery is the rugged suspension architecture. Primarily constructed from aluminum components, the suspension is fully independent, with a widespaced double-wishbone design at the front and an advanced multi-link layout at the rear.

The suspension concept is specifically developed to maximize the unrivalled breadth of capability, offering responsive and agile handling together with supreme ride quality and refinement.

To see the available suspension options please see page 35.

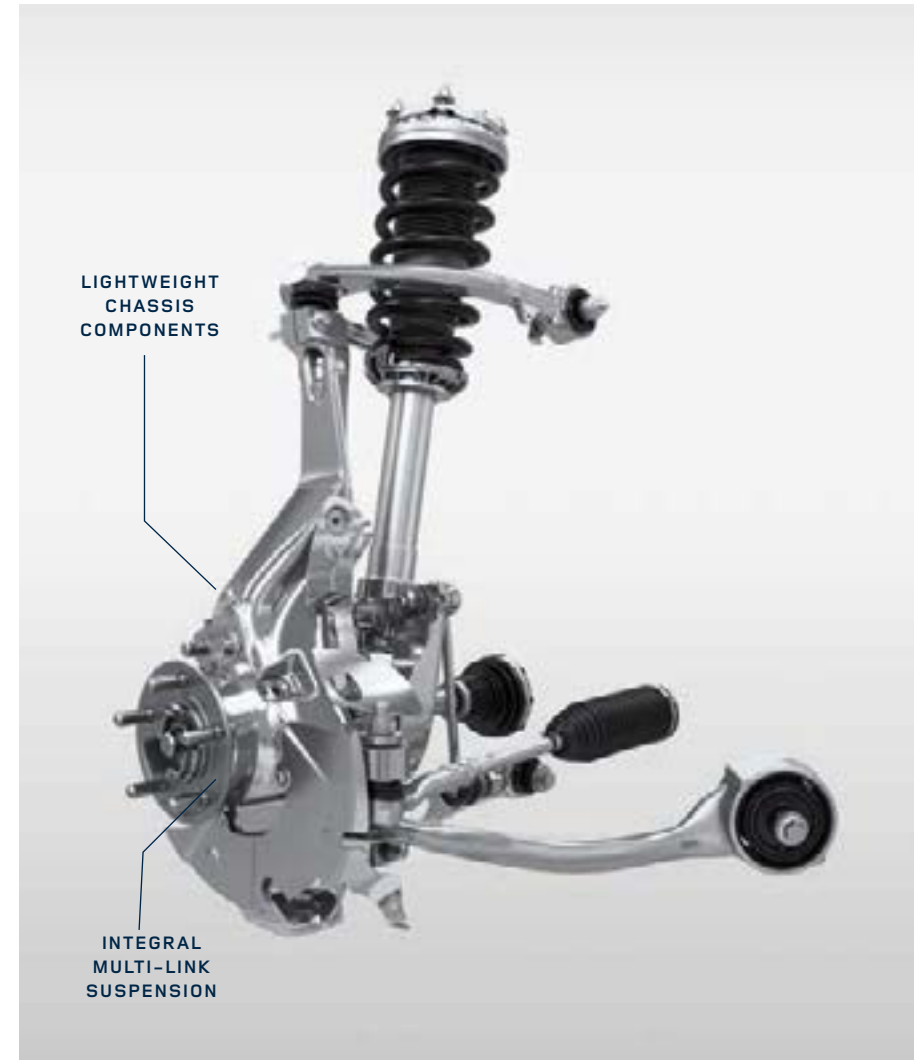



ABOVE & BEYOND

SAFETY

OCCUPANT SAFETY PROTECTION

The body structure protects occupants using a strong and stable safety cell. The crash structure is optimized using computer simulation tools which allows engineers to conduct a significant number of 'virtual' crash tests long before physical prototypes are available.

The occupant safety package includes a comprehensive system of airbags and restraint systems including driver and passenger airbags, side curtain and thorax airbags and seat belt pretensioners*.

The Discovery features six standard airbags and eight airbags when seven seats** are specified.

SEAT BELT PRETENSIONERS*

Acting in conjunction with the airbags, they provide additional protection in the event of a front impact by reducing the forward movement of the occupant.

LATCH CHILD SEAT RESTRAINT SYSTEM POINTS

Up to four* lower LATCH/ISOFIX mountings and associated top tether anchor points are featured on the second and third row seats**. These provide a more secure and easier way of installing child restraints.

CURTAIN AIRBAGS† WITH ROLLOVER SENSING

In the event of a side impact or rollover, curtain airbags are deployed to provide protection against head injuries.

DRIVING AND PARKING AIDS

The Discovery has been designed with driver assistance in mind. There are extensive driving and parking aids available including Autonomous Emergency Braking, Blind Spot Assist and Reverse Traffic Detection, Park Assist and Surround Camera System. In addition, LED lights have been cleverly developed to wrap around the side of the vehicle to enable the indicators to be more visible to improve safety. Adaptive LED headlights, available as an option on SE, HSE and HSE Luxury, combine practicality with distinctive design. For more relaxed night-time driving, adaptive lighting varies the light cast ahead of the vehicle so that the beams follow the curve of the road.

To see the range of driving assistance aids available please see pages 50-51.

To see the range of parking assistance aids available please see page 52-53.

PASSENGER SEAT BELT CHECK SYSTEM



CONTENTS

SPECIFICATIONS

FIND A RETAILER

BUILD YOUR OWN



SAFETY SYSTEMS

- 1 DRIVER AIRBAG
- 2 PASSENGER AIRBAG
- 3 CURTAIN AIRBAGS

- 4 SIDE THORAX AIRBAGS
- 5 SEAT BELT PRETENSIONERS
- 6 SEAT BELT REMINDER

- 7 LATCH CHILD SEAT RESTRAINT SYSTEM/ISOFIX POINTS

*Outboard second row and third row seats only. **Available as part of a package on SE and HSE and fitted as standard on HSE Luxury. †Where third row seats are specified. ‡Please remember that the safety belts in a vehicle constitute the primary protection system for driver and passengers in collisions. Airbags are not designed to deploy in all collisions. The airbag Supplemental Restraint System (SRS) is a supplement to the safety belts and is designed to work as a system with the safety belts. Although airbags provide additional protection, airbags without safety belts do not provide optimal protection in a crash. Always wear your safety belts. Children younger than 13 years old should always be properly restrained in a back seat, away from airbags. Never place an infant seat in the front seat.

Vehicle shown above is HSE Luxury in Namib Orange with optional third row seats**.



ABOVE & BEYOND

CONTENTS

SPECIFICATIONS

FIND A RETAILER

BUILD YOUR OWN



ENVIRONMENTAL

SUSTAINABILITY

The Discovery demonstrates our continuing commitment to enhancing the sustainable performance of our products and operations and our determination to deliver vehicles that are both relevant and highly desirable. As part of our commitment to reducing our environmental footprint, our Engine Manufacturing Center in the UK features over 22,000 solar panels – the largest roof-mounted solar-array in the country.

The Discovery has been designed with a life cycle approach, aiming to use fewer resources, more environmentally sustainable materials and minimize the CO₂ emissions over the entire vehicle's life cycle. Its aluminum structure and optimized powertrains have reduced the environmental impact from material production and development, through to customer use.

The Discovery is built in manufacturing facilities operating to some of the highest environmental standards. By focusing on innovation and efficiency in every aspect of its processes, the company has achieved a 30 percent* reduction in operational CO₂ per vehicle. Manufacturing waste to landfill has been reduced by 79 percent* per vehicle and water use reduced by 34 percent* per vehicle. Investment, commitment and focus in these areas continue to drive further efficiencies. Responsible resource management is integral to the company's long-term sustainability strategy.

*JLR Data 2014/15 vs. 2007.
Vehicle shown is HSE Luxury in Namib Orange.

LIGHTWEIGHT AND SUSTAINABLE MATERIALS

The Discovery incorporates sustainable design with intelligent material choices. The use of aluminum in the body structure enables a reduction in CO₂ emissions over its life cycle. Our closed-loop aluminum supply chain also ensures any surplus high-grade aluminum from our sheet stamping process is re-used. This reduces the need for primary aluminum production, conserving energy and reducing CO₂ emissions in material production while maintaining the highest quality aluminum for our vehicles.

Recycled materials have been used wherever possible, including up to 50 percent closed loop and recycled aluminum in the body. The Discovery HSE Luxury models use over 41 lbs of recycled plastics in the instrument panel, wheel arch liners and bumpers, helping to divert over 8,650 tons of plastic from landfill during the vehicle's production life. The vehicle is designed to meet a requirement of 85 percent Recyclability/Re-usability and 95 percent Recoverability at the end of the vehicle's life.



ABOVE & BEYOND

CONTENTS

SPECIFICATIONS

FIND A RETAILER

BUILD YOUR OWN

THE DISCOVERY OFFERS YOU GREAT OPTIONS AND FLEXIBILITY TO PERSONALIZE YOUR VEHICLE.

The following pages take you through a logical series of steps to make it suit your lifestyle. There are several choices: from selecting your engine and model to exterior and interior colors, wheels, finishes and those detailed touches to enable you to personalize your vehicle. If you'd like to bring your options to life, go to our online configurator at landroverusa.com

78-79

1

**STEP 1
CHOOSE YOUR ENGINE**

You can select from a powerful gasoline or diesel engine.

80-99

2

**STEP 2
CHOOSE YOUR MODEL AND OPTIONS**

Compare the standard and optional features on each model. There's also a choice of package options to personalize your vehicle.

100-103

3

**STEP 3
CHOOSE YOUR COLOR**

A wide range of colors to enable you to express yourself.

104-105

4

**STEP 4
CHOOSE YOUR WHEELS**

There's a range of wheel styles, each one designed to complement the bold exterior.

106-113

5

**STEP 5
CHOOSE YOUR INTERIOR**

When you choose your interior, you can personalize it by selecting your optimum seat configuration, the ideal color combination of seats, materials and your preferred trim. These three considerations help celebrate and enhance a sense of your own style.

114-119

6

**STEP 6
CHOOSE YOUR ACCESSORIES**

This range of stylish and practical accessories can be tailored to suit any lifestyle.

120-121

TECHNICAL DETAILS

Technical information and data for dimensions, performance and specifications.



ABOVE & BEYOND

CONTENTS

SPECIFICATIONS

FIND A RETAILER

BUILD YOUR OWN

STEP 1
CHOOSE YOUR ENGINE



DRIVELINE AND ENGINE PERFORMANCE

The Discovery delivers strong performance from its advanced line-up of refined gas and diesel engines, which are paired with a smooth and responsive 8-speed Automatic Transmission.

	GASOLINE 3.0L Si6	DIESEL 3.0L Td6
	340	254
POWER (HP)		
Driveline	AWD	AWD
Maximum power (hp @ rpm)	340 @ 6,500	254 @ 3,750
Maximum torque (lb/ft @ rpm)	332 @ 3,500-5,000	443 @ 1,750-2,250
Capacity (cc)	2,995	2,993
No. of cylinders	6	6
Valves per cylinder	4	4
Cylinder layout	Longitudinal V6	Longitudinal V6

MODELS BY ENGINE

	SE	HSE	HSE LUXURY
3.0L Si6 Gas 340HP	■	■	■
3.0L Td6 Diesel 254HP	■	■	■

■ Standard.



ABOVE & BEYOND

CONTENTS

SPECIFICATIONS

FIND A RETAILER

BUILD YOUR OWN

STEP 2
CHOOSE YOUR MODEL AND OPTIONS

2

EACH MODEL HAS A CHOICE OF UNIQUE FEATURES

This guide will help you to select your ideal Discovery. On the following pages you'll see the standard features for each model.

DISCOVERY SE



- Dark Atlas grille with Narvik Black surround
- Dark Atlas fender vent ingots with Narvik Black surround
- Dark Techno Silver tow eye covers
- 19" 5 split-spoke 'Style 5021' alloy wheels
- Halogen headlights
- Automatic headlights
- Rain sensing windshield wipers
- Power fold, heated door mirrors with approach lights
- Fixed panoramic roof
- Infrared reflective windshield
- Rear Parking Aid*
- Rear View Camera*
- Keyless Entry
- Powered gesture tailgate
- Two-zone Climate Control
- Seat Package 2 – grained leather seats and 12-way – (10-way electric) front seats
- 60:40 load through rear seats with manual slide and recline
- Ambient Interior Lighting
- Enhanced Sound System 250W with 10 speakers (Touch Pro).

DISCOVERY HSE



- Contents of SE, plus:
- Signature hi-line tail lights
 - Powered inner tailgate
 - Front Parking Aid*
 - SiriusXM Satellite Radio** & HD Radio.
- Replaces SE content:
- Atlas grille with Narvik Black surround
 - Atlas fender vent ingots with Narvik Black surround
 - White Silver tow eye covers
 - Electric sunroof (tilt/slide front glass) with fixed rear glass pano (including power blinds)
 - LED headlights with LED signature

- 20" 5 split-spoke 'Style 5011' alloy wheels
- Interactive Driver Display
- Meridian™ Sound System 380W with 10 speakers plus a dual channel subwoofer (Touch Pro)
- Three-zone Climate Control
- Seat Package 3 – grained leather seats and 12-way – (10-way electric) front seats with driver seat memory.

DISCOVERY HSE LUXURY



- Contents of HSE, plus:
- Front fog lights.

- Replaces HSE content:
- Atlas Discovery script (hood and tailgate)
 - Body-colored door handles with Atlas surround
 - 20" 10 split-spoke 'Style 1011' alloy wheels
 - Meridian™ Surround Sound System 825W with 14 speakers plus a dual channel subwoofer (Touch Pro)
 - Configurable Ambient Interior Lighting
 - Seat Package 4 – Windsor leather seats with 16-way (14-way electric) front seats with driver seat memory
 - Third Row Seating
 - Two Speed Transfer Case
 - Air Suspension.

*These systems are not a substitute for driving safely with due care and attention and will not function under all circumstances, speeds, weather and road conditions, etc. Driver should not assume that these systems will correct errors of judgment in driving. Please consult the owner's manual or your local authorized Land Rover Retailer for more details. To view the full list of standard and optional features available on each Discovery derivative please see the accompanying Specification and Price Guide or visit landroverusa.com

**A 3-month trial subscription to the SiriusXM All Access package is included with the vehicle, which gives you access to 150+ channels of premium programming. Plus you can stream SiriusXM on your computer, smartphone or tablet – it's included in your trial. If you decide to continue service after your trial, the subscription plan you choose will automatically renew thereafter and you will be charged according to your chosen payment method at then-current rates. Fees and taxes apply. To cancel you must call SiriusXM at 1-866-635-2349. See the 22 SiriusXM Customer Agreement for complete terms at siriusxm.com. All fees and programming are subject to change. SiriusXM Satellite Radio is not available in Alaska or Hawaii.



ABOVE & BEYOND

CONTENTS

SPECIFICATIONS

FIND A RETAILER

BUILD YOUR OWN

STEP 2
CHOOSE YOUR MODEL AND OPTIONS



PERSONALIZING YOUR DISCOVERY

COMPLETE DYNAMIC DESIGN PACKAGE

Bold. Arresting. This option, available on HSE and HSE Luxury models, allows you to enhance the vehicle's design cues.

A unique front bumper design gives the exterior a more sporty feel. 21" Satin Dark Grey or 22"*** Satin Dark Grey Diamond Turned finish alloy wheels and a choice of Black or Grey contrast roof* add to the vehicle's presence. Narvik Black features include the mesh grille, fender vents, Discovery hood and tailgate lettering, tailgate appliqué, and mirror caps to enhance the appearance. Carefully selected interior touches add to the impact of the three color choices available in Windsor leather, with premium details including contrast stitching and micropiping.

Dark Brushed Aluminum center stack side rails and the distinctive Titanium Mesh trim complete the look. The interior is enhanced with bespoke premium carpet mats, Bright finish paddle shifters and aluminum sport pedals. Please refer to page 97 for Complete Dynamic Design Package options.



Rear tailgate trim



Ebony seat with Light Oyster contrast micropiping



Titanium Mesh trim finisher



Satin Dark Grey Diamond Turned finish alloy wheels



ENGINE

MODEL AND OPTIONS

COLOR

WHEELS

INTERIOR

ACCESSORIES

TECHNICAL DETAILS





ABOVE & BEYOND

CONTENTS

SPECIFICATIONS

FIND A RETAILER

BUILD YOUR OWN

STEP 2
CHOOSE YOUR MODEL AND OPTIONS



PERSONALIZING YOUR DISCOVERY

BLACK DESIGN PACKAGE

For a striking effect the All-New Discovery can be personalized with the optional Black Design Package. The Black Design Package is available with all exterior color options and includes a Narvik Black grille, fender vents and mirror caps, with Black 'DISCOVERY' hood and tailgate lettering. A choice of 20", 21"* and 22"** Gloss Black alloy wheels are available.



Narvik Black grille



Gloss Black alloy wheels



Narvik Black mirror caps



Narvik Black fender vents

ENGINE

MODEL AND OPTIONS

COLOR

WHEELS

INTERIOR

ACCESSORIES

TECHNICAL DETAILS



ABOVE & BEYOND

CONTENTS

SPECIFICATIONS

FIND A RETAILER

BUILD YOUR OWN

STEP 2
CHOOSE YOUR MODEL AND OPTIONS

STANDARD AND OPTIONAL FEATURES

Engine Transmission, Suspension and Driving Dynamics

	OPTION CODE	3.0L Si6	3.0L Td6	DESCRIPTION
8-speed Automatic Transmission		■	■	Please refer to page 67.
Single-speed transfer box (high range only) (1)		■	■	
Two-speed transfer box (high/low range) (2) (3)		■	■	Please refer to page 35.
Coil suspension (5 seat only) (1)		■	■	Please refer to page 35.
Electronic air suspension (2) (3)		■	■	Please refer to page 35.
Active rear locking differential (4)	027DB	□	□	Please refer to page 35.
Manual center differential (1)		■	■	Standard fitment with single-speed transfer box (high range) only.
Electronic center differential (2) (3)		■	■	Standard fitment with twin-speed transfer box (high/low range) only.
Terrain Response® 4-mode (1) (5)		■	■	Please refer to page 31.
Terrain Response® 5-mode (including Rock Crawl mode) (5)		■	■	Please refer to page 31.
Terrain Response® 2 (5)	088IA	□	□	Please refer to page 31.
All Terrain Progress Control (ATPC) (4) (5)	095CB	□	□	Please refer to page 31.
Stop/Start technology		■	■	Please refer to page 37.
Emergency Braking (EB) (5)		■	■	Please refer to page 50.
Hill Descent Control (HDC®) (5)		■	■	Please refer to page 33.
Anti-lock Braking System (ABS)		■	■	
Electric Power Assisted Steering (EPAS) (5)		■	■	Please refer to page 38.
Electronic Traction Control (ETC) (5)		■	■	
Hill Start Assist Dynamic (5)		■	■	Please refer to page 33.
Stability Control (DSC) (5)		■	■	Please refer to page 38.
Roll Stability Control (RSC) (5)		■	■	
Electric Parking Brake (EPB)		■	■	
Emergency Brake Assist (EBA) (5)		■	■	
Electronic Brake-Force Distribution (EBD) (5)		■	■	
Gradient Acceleration Control (GAC)		■	■	
Trip computer		■	■	

■ Standard □ Optional.

(1) Standard on SE and HSE models. (2) Standard on HSE Luxury models. (3) Only available as part of specific option packages on SE and HSE models. (4) Only available as part of Capability Plus Package. (5) These systems are not a substitute for driving safely with due care and attention and will not function under all circumstances, speeds, weather and road conditions, etc. Driver should not assume that these systems will correct errors of judgment in driving. Please consult the owner's manual or your local authorized Land Rover Retailer for more details.

Exterior Features and Finishers

	OPTION CODE	SE	HSE	HSE LUXURY	DESCRIPTION
ROOF AND EXTERIOR DESIGN					
Black contrast roof (6)	080AN	–	□	□	Please refer to pages 100-103.
Grey contrast roof (6)	080EE	–	□	□	Please refer to pages 100-103.
Electric sunroof (tilt/slide front glass) with fixed rear glass pano (including power blinds)	041CR	□	■	■	Includes rear reading lights. Please refer to page 63.
Fixed panoramic roof (including manual blinds)	041CS	■	Δ	Δ	Includes rear reading lights. Please refer to page 63.
Black roof rails	060AW	□	□	□	
Silver roof rails	060BC	□	□	□	
Brunel grille with Narvik Black surround		–	–	–	
Narvik Black fender vents (7)		–	–	–	
Dark Atlas grille with Narvik Black surround		■	–	–	
Dark Atlas fender vent ingots with Narvik Black surround		■	–	–	
Atlas grille with Narvik Black surround		–	■	■	
Atlas fender vent ingots with Narvik Black surround		–	■	■	
Body-colored door handles	080AW	■	■	□ (8)	
Body-colored door handles with Atlas surround		–	–	■	
Gloss Black tailgate finisher		■	■	■	
Brunel Discovery script (hood and tailgate)		■	■	–	
Atlas Discovery script (hood and tailgate)		–	–	■	
Anthracite tow eye covers		–	–	–	
Dark Techno Silver tow eye covers (7)		■	–	–	
White Silver tow eye covers		–	■	■	

■ Standard □ Optional Δ No Cost Option – Not Available.

(6) Only available as part of Dynamic Design Packages. Availability varies dependent upon exterior paint color. Please refer to pages 100-103. (7) Standard as part of Black Design Package. (8) Standard as part of Dynamic Design Packages and Black Design Package. Replaces body-colored door handles with Atlas surround.



ABOVE & BEYOND

CONTENTS

SPECIFICATIONS

FIND A RETAILER

BUILD YOUR OWN

STEP 2
CHOOSE YOUR MODEL AND OPTIONS

STANDARD AND OPTIONAL FEATURES

Exterior Features and Finishers (continued)

	OPTION CODE	SE	HSE	HSE LUXURY	DESCRIPTION
GLASS AND EXTERIOR MIRRORS					
Acoustic laminated windshield		■	■	■	
Heated rear window with rear wiper		■	■	■	
Door puddle lights		■	■	■	
Heated windshield	040AK	□	□	□	
Heated washer jets (1)	040AQ	□	□	■	
Infrared reflective windshield		■	■	■	This is a fine metallic coating made up of several layers of titanium and silver to create an infrared reflective coating, keeping the vehicle cooler in hot conditions.
Privacy glass		■	■	■	Provides increased privacy for rear passengers by restricting vision into the cabin.
Rain sensing windshield wipers		■	■	■	
Power fold, heated door mirrors with approach lights		■	■	■	
Auto-dimming exterior mirrors (2)	031EB	□	□	□	
TOWING					
Trailer Stability Assist (TSA) (3) (4)		■	■	■	Please refer to page 59.
Front and rear recovery hooks		■	■	■	
Advanced Tow Assist (3) (4) (5)	062CE	-	□	□	Please refer to page 59.
Trailer Hitch with wiring	028BT	□	□	□	

■ Standard □ Optional - Not Available.

(1) Only available as part of specific option packages on HSE and HSE Luxury models. Please refer to pages 97-101 for option packages availability. (2) Only available with Blind Spot Monitor. (3) A Land Rover approved tow bar is required in order to enable this feature. (4) These systems are not a substitute for driving safely with due care and attention and will not function under all circumstances, speeds, weather and road conditions, etc. Driver should not assume that these systems will correct errors of judgment in driving. Please consult the owner's manual or your local authorized Land Rover Retailer for more details. (5) Only available with twin-speed transfer box (high/low range), electronic air suspension, All Terrain Progress Control (ATPC), Surround Camera System, 360° Parking Aid and Terrain Response® 2.

Exterior Features and Finishers (continued)

	OPTION CODE	SE	HSE	HSE LUXURY	DESCRIPTION
WHEEL FEATURES					
Compact alloy spare tire		■	■	■	Includes toolkit.
Full size spare tire	050AQ	□	□	□	Includes toolkit.
Tire Pressure Monitoring System (TPMS)		■	■	■	
HEADLIGHTS AND LIGHTING					
Daytime Running Lights (DRL)		■	■	■	
Front fog lights	064AP	-	□	■	
Halogen headlights		■	-	-	
LED headlights with LED signature	064GK	□	■	■	Signature design LED lights combine distinctive design with highly practical capabilities. Includes headlight power wash.
Signature hi-line tail lights		-	■	■	
Automatic headlights		■	■	■	
Auto High Beam Assist (AHBA) (4)	030NT	□ (6)	□ (7)	□ (7)	Automatic High Beam Assist headlights automatically dip when traffic is detected, reverting when vehicles have passed.
PAINT					
Solid paint		■	■	■	Please refer to pages 100-103.
Metallic paint		□	□	□	Please refer to pages 100-103.
Premium metallic paint		□	□	□	Please refer to pages 100-103.

■ Standard □ Optional - Not Available.

(6) Only available with LED headlights with LED signature. (7) Only available as part of Vision Assist Package.



ABOVE & BEYOND

CONTENTS

SPECIFICATIONS

FIND A RETAILER

BUILD YOUR OWN

STEP 2
CHOOSE YOUR MODEL AND OPTIONS

STANDARD AND OPTIONAL FEATURES

Seating, Interior Features and Finishers

	OPTION CODE	SE	HSE	HSE LUXURY	DESCRIPTION
SEATS					
5 seats		■	■	-	
Third row seats (1)	033BI	□	□	■	Please refer to page 106-107.
Powered third row seats (2)	033QB	-	□	■	Please refer to page 106-107.
60:40 load through rear seats with manual slide and recline		■	■	■	Please refer to page 106-107.
Electrically reclining rear seats (2)	033IR	-	□ (3)	■ (4)	Please refer to page 106-107.
Winged front headrests	033QU	-	□ (4)	■	
Seat Package 2 – consists of Grained leather seats and 12-way (10-way electric) front seats		■	-	-	
Seat Package 3 – Grained leather seats and 12-way (10-way electric) front seats with driver seat memory		-	■	-	
Seat Package 4 – Windsor leather seats with 16-way (14-way electric) front seats with driver seat memory	033VL	-	□	■	
Seat Package 5 – Windsor leather seats with 16-way power front seats with driver seat memory and massage function (5)	033VN	-	-	□	
Heated front and rear seats (6)	033EQ	□ (7)	□ (7)	■	Please refer to page 63.
Heated and cooled front and rear seats (8) (9)	033IN	-	□	□	Please refer to page 63.
Heated and cooled front and rear seats with heated third row seats (2) (9) (10)	033BL	-	□ (11)	□	Please refer to page 63.
Intelligent Seat Fold (12)	095HB	-	□	□	Please refer to page 19.

■ Standard □ Optional – Not Available.

(1) Only available as part of 7 Seat Package. Not available with coil suspension. (2) Only available with third row seats and electrically reclining rear seats. (3) Only available as part of Remote Intelligent Seat Fold Package. (4) Only available on HSE models with Rear Seat Entertainment. (5) Only available as part of Luxury Climate Comfort Package or 7 seat Luxury Climate Comfort Package. (6) Only available with heated front windshield. (7) Only available as part of Cold Climate Package. (8) Only available as part of Luxury Climate Comfort Package. (9) Only available with Seat Package 4 or 5. (10) Only available as part of 7 Luxury Climate Comfort Package. (11) Only available with powered third row seats. (12) Only available with third row seats, electrically reclining rear seats and powered third row seats.

Seating, Interior Features and Finishers (continued)

	OPTION CODE	SE	HSE	HSE LUXURY	DESCRIPTION
STEERING WHEEL					
Manually adjustable steering column (4-way)		■	-	-	
Power adjustable steering column (4-way)		-	■	■	
Premium leather steering wheel with multi-functional controls and gearshift paddles		■	■	■	
Heated steering wheel	032DV	□ (13)	□ (13)	■	A heated leather steering wheel is available for the ultimate driver comfort.
INTERIOR FINISHERS					
Gloss Black finisher		■	-	-	Please refer to page 113.
Dark Satin Brushed Aluminum trim finisher	088HP	□	□	□	Please refer to page 113.
Natural Shadow Oak veneer	088JU	□	■	■	Please refer to page 113.
Natural Charcoal Oak veneer	088HY	-	□	□	Please refer to page 113.
High Gloss Charcoal Oak veneer	088JO	-	□	□	Please refer to page 113.
Titanium Mesh trim finisher (14)	088JV	-	□	□	Please refer to page 113.
Front and rear premium carpet mats	079BO	□	□	■	
HEADLINING					
Light Oyster headlining (15)		■	■	■	
Ebony headlining (16)	005BJ	□	□	□	

■ Standard □ Optional – Not Available.

(13) Only available as part of Cold and Climate option Packages, please refer to pages 100-101. (14) Only available as part of Complete Dynamic Design Package. (15) Not available with Dynamic Design Packages. (16) Standard as part of Complete Dynamic Design Packages. Not available with Light Oyster/Espresso interior colorway.



ABOVE & BEYOND

CONTENTS

SPECIFICATIONS

FIND A RETAILER

BUILD YOUR OWN

STEP 2
CHOOSE YOUR MODEL AND OPTIONS

STANDARD AND OPTIONAL FEATURES

Seating, Interior Features and Finishers (continued)

	OPTION CODE	SE	HSE	HSE LUXURY	DESCRIPTION
INTERIOR FEATURES					
Driver and passenger sunvisors with illuminated vanity mirrors		■	■	■	
Front and rear grab handles		■	■	■	
Illuminated glovebox, overhead console downlight, cargo space light and map light		■	■	■	
Smoker's Package	094AA	□	□	□	Includes ashtray and cigar lighter in front row.
Auto-dimming interior rear view mirror		■	■	■	
Ambient Interior Lighting		■	■	-	
Configurable Ambient Interior Lighting		-	-	■	Please refer to page 63.
Rear reading lights		-	■	■	
Front cupholders		■	-	-	
Front cupholders with cover		-	■	■	Please refer to page 23.
Shopping bag hook (grocery hook)		-	■	■	Please refer to page 23.
Upper secondary glove box		■	■	■	Please refer to page 23.
Front center console cooler compartment	038EA	□	□	□	Please refer to page 23.
Two-zone Climate Control		■	-	-	Please refer to page 63.
Three-zone Climate Control		-	■	■	Please refer to page 63.
Four-zone Climate Control	022BR	-	□	□	Please refer to page 63.
STORAGE					
Overhead storage for sunglasses (1)		■	■	■	
Rear armrest with cupholders		■	■	■	Please refer to page 22.
Center console with central hinged twin lidded storage		■	■	■	Please refer to page 23.
Lower center console storage		■	■	■	Please refer to page 23.
Third row side storage with lid and single 5V charging point (2)		■	■	■	Please refer to page 23.
In-dash storage		-	■	■	Please refer to page 23.

■ Standard □ Optional - Not Available.

(1) Not available when Rear Seat Entertainment is fitted. (2) Only available with third row seats.

Safety and Security

	OPTION CODE	SE	HSE	HSE LUXURY	DESCRIPTION
Seat belt reminder (including third row)		■	■	■	Please refer to page 73.
Front side impact airbags (3)		■	■	■	Please refer to page 73.
Perimetric alarm		■	■	■	
Rollover deployment of restraints		■	■	■	Please refer to page 73.
Side curtain airbags (3)		■	■	■	Please refer to page 72.
Third row LATCH		■	■	■	Standard when third row seats are specified. Please refer to page 72.

■ Standard.

(3) Please remember that the safety belts in a vehicle constitute the primary protection system for driver and passengers in collisions. Airbags are not designed to deploy in all collisions. The airbag Supplemental Restraint System (SRS) is a supplement to the safety belts and is designed to work as a system with the safety belts. Although airbags provide additional protection, airbags without safety belts do not provide optimal protection in a crash. Always wear your safety belts. Children younger than 13 years old should always be properly restrained in a back seat, away from airbags. Never place an infant seat in the front seat.



ABOVE & BEYOND

CONTENTS

SPECIFICATIONS

FIND A RETAILER

BUILD YOUR OWN

STEP 2
CHOOSE YOUR MODEL AND OPTIONS

STANDARD AND OPTIONAL FEATURES

Driver Assistance, Convenience and Cargo space Features

	OPTION CODE	SE	HSE	HSE LUXURY	DESCRIPTION
Push Button Start		■	■	■	
Cruise Control (1)		■	■	■	
Adaptive Cruise Control with Queue Assist (1) (2)	065AG	□	□	□	Please refer to page 50.
Lane Departure Warning (1)		□	□	□	
Driver Condition Monitor (1) (3)	086DH	□	□	□	Please refer to page 51.
Lane Keep Assist (1) (2)	086BG	-	□	□	Please refer to page 51.
Rear Parking Aid (1)		■	■	■	
Front Parking Aid (1)	086EG	□	■	■	
360° Parking Aid	036MB	□	□	□	Sensors located around the vehicle are automatically triggered when reverse is selected, or can be manually activated, with a display appearing on the Touchscreen showing an overhead view of the vehicle. As you park, the Touchscreen display and audio feedback indicates how close you are to obstacles.
Park Assist (1) (4)	086HA	□	□	□	Please refer to page 53.
Rear View Camera (1)		■	■	■	Please refer to page 52.
Surround Camera System (1) (5)	086GC	□	□	□	Please refer to page 52.
Traffic Sign Recognition and Intelligent Speed Limiter (1) (3)	086DC	□	□	□	Please refer to page 51.
Blind Spot Monitor and Reverse Traffic Detection (1) (6) (7)	086GF	□	□	□	Please refer to page 51.
Blind Spot Assist (1) (2) (7)	086GG	□	□	□	Please refer to page 51.

■ Standard □ Optional – Not Available.

(1) These systems are not a substitute for driving safely with due care and attention and will not function under all circumstances, speeds, weather and road conditions, etc. Driver should not assume that these systems will correct errors of judgment in driving. Please consult the owner's manual or your local authorized Land Rover Retailer for more details. (2) Option only available as part of Drive Pro Package. (3) Option only available as part of Drive Package or Drive Pro Package. (4) Requires 360° Parking Aid. (5) Option only available as part of Vision Assist Package. (6) Option only available as part of Drive Package. (7) Option only available with auto-dimming exterior mirrors.

Driver Assistance, Convenience and Cargo space Features (continued)

	OPTION CODE	SE	HSE	HSE LUXURY	DESCRIPTION
Keyless Entry		■	■	■	The driver is able to access the vehicle without the need to take the remote smart key out of a bag or pocket.
Activity Key	066CA	□	□	□	Please refer to page 65.
Garage Door Opener (HomeLink®)		■	■	■	Please refer to page 61.
Cabin Air Ionization	022GB	□	□	□	
CARGO SPACE FEATURES					
Luggage retention loops		■	■	■	
Cargo space cover	063AH	□	□	□	
Cargo space storage rails (8)	135AH	□	□	-	
Cargo space partition net	026EU	□	□	□	
Powered gesture tailgate		■	■	■	
Powered inner tailgate	079EC	□	■	■	

■ Standard □ Optional – Not Available.
(8) Only available with 5 seats.



ABOVE & BEYOND

CONTENTS

SPECIFICATIONS

FIND A RETAILER

BUILD YOUR OWN

STEP 2
CHOOSE YOUR MODEL AND OPTIONS

STANDARD AND OPTIONAL FEATURES

Information, Communication and Entertainment

	OPTION CODE	SE	HSE	HSE LUXURY	DESCRIPTION
10" Touchscreen (1)		■	■	■	
Enhanced Sound System 250W with 10 speakers		■	-	-	Please refer to page 42.
Meridian™ Sound System 380W with 10 speakers and a dual channel subwoofer	025LM	□	■	-	Please refer to page 42.
Meridian™ Surround Sound System 825W with 14 speakers and a dual channel subwoofer	025LN	-	□	■	Please refer to page 42.
Bluetooth® connectivity (1)		■	■	■	
SiriusXM® Satellite Radio & HD Radio™ (2)	025LA	□	■	■	
Rear Seat Entertainment (3)	129AH	-	□	□	Please refer to page 41.
Protect (1)		■	■	■	Please refer to page 47.
Navigation Pro (1)		■	■	■	Please refer to page 45.
Remote (1)		■	■	■	Please refer to page 46.
Pro Services (1) and Wi-Fi Hotspot (4)		■	■	■	Please refer to page 45.
InControl Apps (1)		■	■	■	Please refer to page 47.
Head-up Display (5)	039IB	-	□	□	Please refer to page 41.
Analog Dials with Central TFT Display		■	-	-	
Interactive Driver Display	038ID	□	■	■	
Single 12V auxiliary charging point (upper glovebox)		■	■	■	
Twin 12V auxiliary charging points (second row)	054AM	■	□	□	
USB sockets (second row)	054AN	□	■	■	Please refer to page 49.

■ Standard □ Optional - Not Available.

The Bluetooth® word mark and logos are owned by the Bluetooth SIG, Inc. and any use of such marks by Land Rover is under license.

(1) Driving while distracted can result in loss of vehicle control. Do not operate, adjust or view the navigation or multimedia systems under conditions that will affect your safety or the safety of others. Only use mobile phones and other devices, even with voice commands, when it is safe to do so. (2) A 3-month trial subscription to the SiriusXM All Access package is included with the vehicle, which gives you access to 150+ channels of premium programming. Plus you can stream SiriusXM on your computer, smartphone or tablet – it's included in your trial. If you decide to continue service after your trial, the subscription plan you choose will automatically renew thereafter and you will be charged according to your chosen payment method at then-current rates. Fees and taxes apply. To cancel you must call SiriusXM at 1-866-635-2349. See the SiriusXM Customer Agreement for complete terms at siriusxm.com. All fees and programming are subject to change. SiriusXM Satellite Radio is not available in Alaska or Hawaii. Certain features require a Micro SIM with a suitable. (3) Overhead storage for sunglasses is not available with Rear Seat Entertainment. HSE models require winged headrests. (4) The Wi-Fi Hotspot is intended for passenger use only. InControl features may require an additional subscription with separate terms and conditions. (5) Requires Infrared Reflective Windshield.

Option Packages

	OPTION CODE	SE	HSE	HSE LUXURY
COMPLETE DYNAMIC DESIGN PACKAGE (6)	032IN			
Black or Grey contrast roof (7)		-	□	□
Dynamic exterior		-	□	□
Dynamic interior (8)		-	□	□
BLACK DESIGN PACKAGE	074LN			
Black exterior		□	□	□
CONNECT PRO PACKAGE	011CF			
Pro Services and Wi-Fi Hotspot		■	■	■
InControl Apps		■	■	■
Remote Premium		■	■	■
DRIVE PACKAGE	074VX			
Driver Condition Monitor		□	□	□
Blind Spot Monitor and Reverse Traffic Detection		□	□	□
Traffic Sign Recognition and Adaptive Speed Limiter		□	□	□
DRIVE PRO PACKAGE	074VY			
Driver Condition Monitor		□	□	□
Blind Spot Assist and Reverse Traffic Detection		□	□	□
Traffic Sign Recognition and Adaptive Speed Limiter		□	□	□
Adaptive Cruise Control with Queue Assist		□	□	□
Lane Keep Assist		-	□	□

■ Standard □ Optional - Not Available.

(6) Not available with Black Design Package. (7) Dependent on exterior paint Package. Please refer to pages 100-103. Body-colored roofs are also available. (8) Please refer to pages 110-112 for available interior colorways.



ABOVE & BEYOND

CONTENTS

SPECIFICATIONS

FIND A RETAILER

BUILD YOUR OWN

STEP 2
CHOOSE YOUR MODEL AND OPTIONS

STANDARD AND OPTIONAL FEATURES

Option Packages (continued)

	OPTION CODE	SE	HSE	HSE LUXURY
7 SEAT PACKAGE (1)	074SC			
Third row seats		<input type="checkbox"/>	<input type="checkbox"/>	-
Electronic air suspension		<input type="checkbox"/>	<input type="checkbox"/>	-
Two-speed transfer case (high/low range)		<input type="checkbox"/>	<input type="checkbox"/>	-
CAPABILITY PACKAGE (2) (3)	074GU			
Two-speed transfer case (high/low range)		<input type="checkbox"/>	<input type="checkbox"/>	-
Terrain Response® 2		<input type="checkbox"/>	<input type="checkbox"/>	-
Electronic air suspension		<input type="checkbox"/>	<input type="checkbox"/>	-
CAPABILITY PLUS PACKAGE (2) (4)	074PM			
Active rear locking differential		-	<input type="checkbox"/>	<input type="checkbox"/>
Terrain Response® 2		-	<input type="checkbox"/>	<input type="checkbox"/>
All Terrain Progress Control (ATPC)		-	<input type="checkbox"/>	<input type="checkbox"/>
COLD CLIMATE PACKAGE (5) (6)	072AC			
Heated washer jets		<input type="checkbox"/>	<input type="checkbox"/>	-
Heated steering wheel		<input type="checkbox"/>	<input type="checkbox"/>	-
Heated front and rear seats		<input type="checkbox"/>	<input type="checkbox"/>	-

Optional – Not Available.

(1) Not available with Capability Package or Capability Plus Package. (2) These systems are not a substitute for driving safely with due care and attention and will not function under all circumstances, speeds, weather and road conditions, etc. Driver should not assume that these systems will correct errors of judgment in driving. Please consult the owner's manual or your local authorized Land Rover Retailer for more details. (3) Not available with Capability Plus Package and 7 Seat Package. (4) Not available with Capability Package. Only available with third row seats on HSE. (5) Not available with other Climate Package options. (6) Not available with Seat Package 5.

Option Packages (continued)

	OPTION CODE	SE	HSE	HSE LUXURY
LUXURY CLIMATE COMFORT PACKAGE (7)	072BL			
Heated and cooled front and rear seats		-	<input type="checkbox"/>	-
Four-zone Climate Control		-	<input type="checkbox"/>	-
Seat Package 4		-	<input type="checkbox"/>	-
Heated windshield		-	<input type="checkbox"/>	-
Heated washer jets		-	<input type="checkbox"/>	-
Heated steering wheel		-	<input type="checkbox"/>	-
7 SEAT LUXURY CLIMATE COMFORT PACKAGE (7) (8)	072BP			
Heated and cooled front and rear seats with heated third row seats		-	<input type="checkbox"/>	<input type="checkbox"/>
Four-zone Climate Control		-	<input type="checkbox"/>	<input type="checkbox"/>
Seat Package 4		-	<input type="checkbox"/>	-
Seat Package 5		-	-	<input type="checkbox"/>
Heated windshield		-	<input type="checkbox"/>	<input type="checkbox"/>
Heated washer jets		-	<input type="checkbox"/>	-
Heated steering wheel		-	<input type="checkbox"/>	-
REMOTE INTELLIGENT SEAT FOLD PACKAGE (8)	074VP			
Intelligent Seat Fold		-	<input type="checkbox"/>	-
Electrically reclining rear seats		-	<input type="checkbox"/>	-
Powered third row seats		-	<input type="checkbox"/>	-
VISION ASSIST PACKAGE (9)	041CB			
Auto High Beam Assist (AHBA)		-	<input type="checkbox"/>	<input type="checkbox"/>
Auto-dimming exterior mirrors		-	<input type="checkbox"/>	<input type="checkbox"/>
Surround Camera System		-	<input type="checkbox"/>	<input type="checkbox"/>

Optional – Not Available.

(7) Not available with other Climate Package options. (8) Only available with third row seats. (9) These systems are not a substitute for driving safely with due care and attention and will not function under all circumstances, speeds, weather and road conditions, etc. Driver should not assume that these systems will correct errors of judgment in driving. Please consult the owner's manual or your local authorized Land Rover Retailer for more details.



ABOVE & BEYOND

CONTENTS

SPECIFICATIONS

FIND A RETAILER

BUILD YOUR OWN

STEP 3
CHOOSE YOUR COLOR

3

CHOOSE YOUR COLOR

Now you have chosen your Discovery model, you can select your exterior paint color. From rich, deep lusters to incandescent metallic patinas, our paints incorporate the latest in pigment technologies. Our solid paints produce a deep flat color. Our metallics deliver a sparkle finish that is sure to catch the eye. And our premium metallic paints enhance both the color and the intensity of the sparkle, or sleek metallic finish to give your vehicle even more presence.

Fuji White (solid)

Optional Contrast Roof Color*

Black Grey



Yulong White (metallic)

Optional Contrast Roof Color*

Black Grey



Indus Silver (metallic)

Optional Contrast Roof Color*

Black Grey



Narvik Black (solid)

Optional Contrast Roof Color*

Grey



Corris Grey (metallic)

Optional Contrast Roof Color*

Black



*Contrast roof only available as part of Complete Dynamic Design Packages.

The availability of exterior paint colors varies by model and by time of year. Please contact your nearest Land Rover Retailer for further details.



ABOVE & BEYOND

CONTENTS

SPECIFICATIONS

FIND A RETAILER

BUILD YOUR OWN

STEP 3
CHOOSE YOUR COLOR

Loire Blue (metallic)
Optional Contrast Roof Color*
Black Grey



Santorini Black (metallic)
Optional Contrast Roof Color*
Grey



Namib Orange (premium metallic)
Optional Contrast Roof Color*
Black Grey



Farallon Black (premium metallic)
Optional Contrast Roof Color*
Grey



Byron Blue (metallic)
Optional Contrast Roof Color*
Black Grey



Silicon Silver (premium metallic)
Optional Contrast Roof Color*
Black



Carpathian Grey (premium metallic)
Optional Contrast Roof Color*
Black Grey





ABOVE & BEYOND

CONTENTS

SPECIFICATIONS

FIND A RETAILER

BUILD YOUR OWN

**STEP 4
CHOOSE YOUR WHEELS**

4 CHOOSE YOUR WHEELS



	OPTION CODE	SE	HSE	HSE LUXURY
WHEELS				
19" 5 split-spoke 'Style 5021'		■	-	-
20" 5 split-spoke 'Style 5011'	031HG	□	■	-
20" 5 split-spoke 'Style 5011' with Gloss Black finish	031HJ	□	□	□
20" 10 split-spoke 'Style 1011'	031HH	□	□	■
21" 9 spoke 'Style 9002'	031HK	□	□	□

21" and 22" wheels only available with electronic air suspension.

	OPTION CODE	SE	HSE	HSE LUXURY
WHEELS				
21" 9 spoke 'Style 9002' with Diamond Turned finish	031HM	-	□	□
21" 10 split-spoke 'Style 1012'	031HL	□	□	□
21" 10 split-spoke 'Style 1012' with Gloss Black finish	031HN	-	□	□
21" 5 split-spoke 'Style 5025' with Satin Dark Grey finish	031GD	-	□	□
22" 5 split-spoke 'Style 5011'	031GE	-	-	□
22" 5 split-spoke 'Style 5011' with Gloss Black finish	031GF	-	-	□
22" 5 split-spoke 'Style 5025' with Satin Dark Grey Diamond Turned finish	031GH	-	-	□
22" 5 split-spoke 'Style 5025' with Machine Polished finish (1)	VPLRW0117	□	□	□

21" and 22" wheels only available with electronic air suspension.



ABOVE & BEYOND

CONTENTS

SPECIFICATIONS

FIND A RETAILER

BUILD YOUR OWN

STEP 5
CHOOSE YOUR INTERIOR

5

CHOOSE YOUR INTERIOR – SEAT CONFIGURATION



Power Reclining Rear Seats*

Available on HSE** and HSE Luxury with third row seats, these seats have forwards/backwards movement of 6.3" allowing flexible use of space for luggage or to maximize passenger legroom. The seats also power recline up to 27° and allow for load-through to provide greater comfort and convenience.

60:40 Manual Slide and Recline Seats (not shown)

Standard on SE and HSE, the 60:40 five-seat configuration features three comfortable seating positions and load-through feature.



Seven Full-Size Seats with Stadium Seating*†

Neatly integrated third row of seats gives you more versatility, with the third row easily accessed at the touch of a button. On HSE and HSE Luxury models, the third row has the option of heating, as well as the capability of

power folding. The Discovery makes light work of carrying you and six other adults in the most comfortable and contemporary surroundings.



ABOVE & BEYOND

CONTENTS

SPECIFICATIONS

FIND A RETAILER

BUILD YOUR OWN

STEP 5
CHOOSE YOUR INTERIOR

CHOOSE YOUR INTERIOR – COLOR COMBINATIONS

Now you have chosen your model, you can use this table to select the perfect combination of interior color, exterior color and interior finishers.

	(A)	(B)	(C)	(D)	(E)	EXCLUSIVE TO COMPLETE DYNAMIC DESIGN PACKAGE		
	EBONY / EBONY (page 110)	ACORN / EBONY (page 111)	LIGHT OYSTER / ESPRESSO (page 111)	VINTAGE TAN / EBONY (page 110)	GLACIER / EBONY (page 111)	EBONY / EBONY with Light Oyster detail (page 112)	EBONY / EBONY with Pimento detail (page 112)	LIGHT OYSTER / EBONY with Reims Blue detail (page 112)
COLOR COMBINATIONS								
INTERIOR COLOR								
Seat color	Ebony	Acorn	Light Oyster	Vintage Tan	Glacier	Ebony	Ebony	Light Oyster
Carpet	Ebony	Ebony	Espresso	Ebony	Ebony	Ebony	Ebony	Ebony
MODEL								
SE (Grained leather)	o	o	-	-	-	-	-	-
HSE (Grained leather)	o	o	o	-	-	-	-	-
HSE (Windsor leather)	o	-	o	o	-	o	o	o
HSE LUXURY (Windsor leather)	o	-	o	o	o	o	o	o
INTERIOR FINISHERS								
Gloss Black finisher*	o	o	-	-	-	-	-	-
Brushed Linear Aluminum trim finisher	o	o	o	o	o	-	-	-
Natural Shadow Oak veneer	o	o	o	o	o	-	-	-
Natural Charcoal Oak veneer**	o	o	o	o	o	-	-	-
High Gloss Charcoal Oak veneer**	o	o	o	o	o	-	-	-
Titanium Mesh trim finisher	-	-	-	-	-	o	o	o
EXTERIOR COLOR								
Fuji White	o	o	o	▲	o	o	o	o
Yulong White	▲	o	o	▲	o	▲	▲	o
Indus Silver	▲	o	o	o	o	o	o	o
Silicon Silver	o	▲	▲	o	▲	o	o	▲
Corris Grey	▲	o	o	o	o	o	o	▲
Carpathian Grey	▲	o	o	▲	▲	▲	▲	o
Namib Orange	▲	o	▲	o	o	▲	o	o
Byron Blue	o	o	o	o	o	▲	o	▲
Loire Blue	o	o	o	o	o	o	o	▲
Narvik Black	o	o	o	o	o	o	o	o
Santorini Black	o	▲	o	o	▲	▲	▲	o
Farallon Black	o	o	o	▲	o	o	o	▲



	1	2	3	4	5	6
COLOR COMBINATIONS	DOOR LOWER	DOOR TOP	INSTRUMENT PANEL UPPER	CENTER STACK SIDE RAILS	CENTER CONSOLE LID	INSTRUMENT PANEL MID-SECTION
(A) Ebony/Ebony	Ebony	Ebony	Ebony	Gloss Black*	Ebony	Ebony
(B) Acorn/Ebony	Ebony	Acorn	Ebony	Gloss Black**	Ebony	Acorn
(C) Light Oyster/Espresso	Espresso	Light Oyster	Espresso	Light Oyster Brushed Aluminum	Espresso	Light Oyster
(D) Vintage Tan/Ebony	Ebony	Vintage Tan†	Ebony	Satin Brushed Aluminum	Ebony	Vintage Tan†
(E) Glacier/Ebony	Ebony	Glacier	Ebony	Light Oyster Brushed Aluminum	Ebony	Glacier
EXCLUSIVE TO COMPLETE DYNAMIC DESIGN PACKAGE						
(F) Ebony/Ebony with Light Oyster detail	Ebony	Ebony	Ebony	Dark Brushed Aluminum	Ebony	Ebony
(G) Ebony/Ebony with Pimento detail	Ebony	Ebony	Ebony	Dark Brushed Aluminum	Ebony	Ebony
(H) Light Oyster/Ebony with Reims Blue detail	Ebony	Light Oyster	Ebony	Dark Brushed Aluminum	Ebony	Light Oyster

▲ Combination is Designer's Choice o Combination is Available - Not Available.

108 *Available on SE models only. **Available on HSE and HSE Luxury models only.

The above table is designed as a guide. Please contact your nearest Land Rover Retailer for more information.

*Satin Brushed Aluminum on HSE and HSE Luxury models. **Satin Brushed Aluminum on HSE (Grained leather). †Ebony on HSE (Windsor leather).

Interior shown above is HSE Luxury in Light Oyster/Espresso.

Visit landroverusa.com to configure your vehicle online. 109

ENGINE

MODEL AND OPTIONS

COLOR

WHEELS

INTERIOR

ACCESSORIES

TECHNICAL DETAILS



ABOVE & BEYOND

CONTENTS

SPECIFICATIONS

FIND A RETAILER

BUILD YOUR OWN

STEP 5
CHOOSE YOUR INTERIOR

AVAILABLE INTERIOR COLOR COMBINATIONS

The cabin embodies the finest of contemporary living. Bold horizontal and vertical lines and superb levels of comfort create a space in which you and your family and friends will want to spend time. A wide range of colors and seat material choices are available.

A **Ebony / Ebony** (available on SE, HSE and HSE Luxury)



Interior shown: SE interior in Ebony/Ebony with Seat Package 2 Ebony Grained leather seats, and Gloss Black finisher.

B **Acorn / Ebony** (available on SE and HSE)



Interior shown: SE interior in Acorn/Ebony with Seat Package 2 Acorn Grained leather seats, and Gloss Black finisher.

C **Light Oyster / Espresso** (available on HSE and HSE Luxury)



Interior shown: HSE interior in Light Oyster/Espresso with Seat Package 3 Light Oyster Grained leather seats, and Natural Shadow Oak veneer.

D **Vintage Tan / Ebony** (available on HSE and HSE Luxury)



Interior shown: HSE Luxury interior in Vintage Tan/Ebony with Seat Package 4 Vintage Tan Windsor leather seats with Ebony contrast micropiping, and Natural Charcoal Oak veneer.

E **Glacier / Ebony** (available on HSE Luxury)



Interior shown: HSE Luxury interior in Glacier/Ebony with optional Seat Package 5 Glacier Windsor leather seats with Ebony contrast micropiping, and Natural Shadow Oak veneer.



ABOVE & BEYOND

CONTENTS

SPECIFICATIONS

FIND A RETAILER

BUILD YOUR OWN

STEP 5
CHOOSE YOUR INTERIOR

F Ebony / Ebony with Light Oyster stitching and piping
(available on Complete Dynamic Design Package only)



Interior shown: Ebony/Ebony Windsor leather interior, Ebony seats with Light Oyster stitching and piping and Titanium Mesh trim finisher.

G Ebony / Ebony with Pimento stitching and piping
(available on Complete Dynamic Design Package only)



Interior shown: Ebony/Ebony Windsor leather interior, Ebony seats with Pimento stitching and piping and Titanium Mesh trim finisher.

H Light Oyster / Ebony with Reims Blue stitching and piping
(available on Complete Dynamic Design Package only)



Interior shown: Light Oyster/Ebony Windsor leather interior, Light Oyster seats with Reims Blue stitching and piping and Titanium Mesh trim finisher.

INTERIOR FINISHERS

Now you have chosen your interior color combination, choose one of six interior finishers. For full availability and designer's choices, please see the color and trim matrix on pages 108 and 109.



Brushed Linear Aluminum trim finisher



High Gloss Charcoal Oak veneer

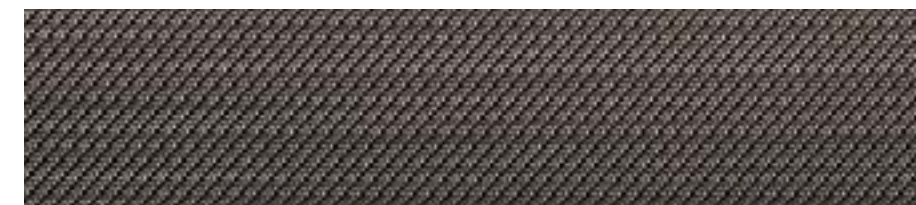

Titanium Mesh trim finisher*



Gloss Black finisher



Natural Charcoal Oak veneer



Natural Shadow Oak veneer



ABOVE & BEYOND

CONTENTS

SPECIFICATIONS

FIND A RETAILER

BUILD YOUR OWN

STEP 6
CHOOSE YOUR ACCESSORIES

6

LAND ROVER GEAR – ACCESSORIES

The Discovery is so capable and adaptable it can get straight to work across a huge variety of vastly differing conditions and roles. Owners can tailor their Discovery to their specific needs with a range of stylish, practical accessories that are tough, versatile and personalized.



These accessories can be added by your Land Rover Retailer at any stage during your vehicle's life – not just when it's new. Land Rover Approved Accessories are designed, tested and manufactured to the same exacting standards as the original equipment fitted to your vehicle.

DESIGN



Cargo space Rigid Organizer System
VPLRS0355

Convenient cargo space organizer tray provides segregated compartments to store wet, dirty or delicate items or separate shopping/luggage. The front and rear compartments also have flexible dividers to create smaller compartments within them. Featuring two lockable lids, it is secured via cargo space 'D' loops*.



Stainless Steel Undershield – Front*
VPLRP0254

Stainless Steel Undershield – Rear*
VPLRP0255 – Without Tow Hitch
VPLRP0256 – With Tow Hitch

The off-road designed undershield, manufactured from stainless steel, features a premium Bright Polished finish for the front and rear of the vehicle.



Sports Pedal Covers**
VPLGS0160

Stainless steel Bright finish sports pedal covers are easy to fit and feature hidden fixings for a clean finish.



Bright Side Tubes†
VPLRP0270

Highly polished stainless steel side tubes provide an off-road inspired appearance, designed to complement the vehicle's exterior design.



Deployable Side Steps†

Please contact your nearest Land Rover Retailer for fitment options. These smart, practical steps make it easier to get in and out of the vehicle.



Fixed Side Steps†
VPLRP0269

The side step aids entry and exit to the vehicle and improve access to the roof. Design features include Bright stainless steel edge trim and a rubber tread mat.



ABOVE & BEYOND

CONTENTS

SPECIFICATIONS

FIND A RETAILER

BUILD YOUR OWN

STEP 6
CHOOSE YOUR ACCESSORIES

TOURING



Click and Go System
VPLRS0388 – Click and Go Base
VPLRS0389 – Click and Hook
VPLRS0395 – Click and Work

Click and Hook is a universal hook that creates extra storage space for items to be hung. Click and Work is a folding table especially useful on long journeys and offers the rear passengers a practical surface providing some office space and a cupholder. Click and Go Base required for all attachments.



Click and Go System
VPLRS0390 – Click and Hang
VPLRS0391 – Click and Play (iPad® 2 – 4)
VPLRS0392 – Click and Play (iPad® Air)
VPLRS0393 – Click and Play (iPad® Mini)
VPLRS0394 – Click and Play Samsung Galaxy Tab (10.1")

Click and Hang is a removable coat hanger allowing for shirts and jackets to be kept crease-free while transporting. Click and Play is a removable tablet holder attachment which is available for various tablets, and can be easily positioned in multiple angles for in cabin comfort and rear entertainment.



Center Armrest Cooler/Warmer Box
VPLV50176

Food and drinks chiller and warmer that acts as a rear center armrest. With a leather-covered top, it is held in place by the center seat belt and powered from the rear auxiliary socket. Ideal for long journeys with the family.

SPORTING

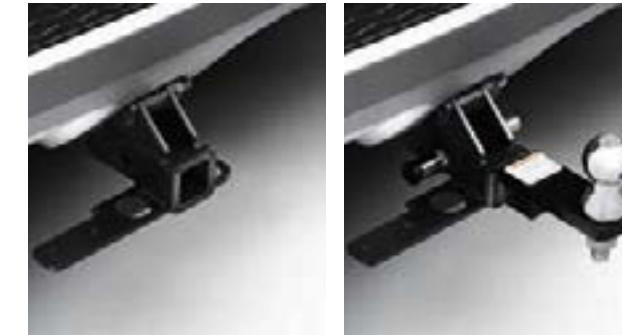

Tow Bar Receiver
VPLRT0174

Tow Draw Bar
VPLRT0177



Roof Mounted Bike Carrier – Wheel Mounted*
VPLFR0091

Lockable bike carrier designed for holding a single bike, up to 44 lbs.



Aqua Sports Carrier*
VPLGR0107

Aqua Sports Carrier – 2 Kayaks (not shown)*
VPLWR0099

Carries one canoe or kayak (2 Kayak Carrier carries two kayaks or canoes). Includes lockable multi-purpose holder to carry oars or paddles. Tilts to facilitate easy loading/unloading. Features lockable straps and rubber supports to maintain optimum weight distribution while protecting the kayak and vehicle from scratches/scuffs. Maximum load capacity 99 lbs.



Sunshades
VPLRS0367 – Second row
VPLRS0363 – Third row
VPLRS0364 – Rear tailgate

Easy to install or remove these sun blinds provide increased comfort helping to protect the interior from heat and glare of the sun.



Roof Rails*
VPLRR0156 – Silver
VPLRR0155 – Black (not shown)

Roof rails facilitate easy fitment of cross bars for roof carrying. Pre-set positioning points ensure cross bars are fixed in optimum position for weight distribution and dynamics. Maximum payload 176 lbs.**

Cross Bars*
VPLRR0154

Elegant, durable Bright finish aluminum cross bars, with compact design which utilizes the full length of the bars, providing space to mount multiple accessories. Aerodynamic profile minimizes drag and wind noise. Maximum payload 163 lbs.**



Roof Box*
VPLWR0100 – Large Sports Roof Box*
VPLVR0062 – Luggage Box* (not shown)
VPLVR0061 – Sports Roof Box* (not shown)

Available in a range of sizes, all versions can be mounted either side for curbside opening in any country and include integral locks for security and peace of mind. Carrying capacity ranges from 11.3 cu.ft. for the Sports Box to the 14.5 cu.ft. Luggage Box or the capacious 15.2 cu.ft. Large Sports Box. Maximum payload 126 lbs.**



Ski/Snowboard Carrier*
LR006849

Carries four pairs of skis or two snowboards and incorporates slider rails for easy loading, is also lockable for security. Maximum payload 79 lbs.**



Protective Seat Covers
VPLRS0335PVJ – First Row – Ebony
VPLRS0337LKP – First Row – Light Oyster
VPLRS0336PVJ – Second Row – Ebony (not shown)
VPLRS0338LKP – Second Row – Light Oyster (not shown)

Protects seats from wet, dirty clothes as well as general wear and tear. Simple to fit and easily wipeable. Includes headrest and armrest covers.



Body Side Moldings
VPLRP0286 – Bright finish
VPLRP0285 – Black finish (not shown)

Enhances the side of your vehicle and provides protection for your door panels from accidental damage by adjacent vehicles.

*Roof rails and cross bars are required for all Land Rover roof mounted accessories. Ditch finishers (VPLRR0157) and alpine light kit (VPLRR0158) are required for fitment of roof rails. Objects placed above the roof mounted satellite antenna may reduce the quality of the signal received by the vehicle and could have a detrimental effect on the navigation and satellite radio system, if fitted. **Maximum payload equals the load capacity of the roof mounted accessory. iPad® is a registered trademark of Apple Inc., registered in the US and other countries.

ENGINE

MODEL AND OPTIONS

COLOR

WHEELS

INTERIOR

ACCESSORIES

TECHNICAL DETAILS



ABOVE & BEYOND

CONTENTS

SPECIFICATIONS

FIND A RETAILER

BUILD YOUR OWN

STEP 6
CHOOSE YOUR ACCESSORIES

ACTIVE



Mirror covers
VPLGB0073 – Noble Chrome
VPLAB0132 – Chrome (not shown)

Noble plated mirror covers designed to enhance the exterior design cues. This neat upgrade complements various Atlas and Bright finish exterior trim.



Cargo space Partition
VPLRS0374 – Full Height
VPLRS0376 – Luggage Partition Divider
VPLRS0375 – Half Height (not shown)
VPLRS0386 – Cargo space Liner Tray (not shown)

Designed to prevent luggage from entering the passenger compartment. The design of the luggage partition has been optimized to second row seating featuring tilt functionality. The Luggage Partition Divider can be fitted to the luggage partition to separate the cargo space into two sections. Semi-rigid waterproof cargo space liner tray with a raised lip on three sides to protect cargo space floor and side wall carpets from dirt or wet equipment.



Cargo space Rubber Mat*
VPLRS0375PVJ – Ebony
VPLRS0375AAM – Espresso (not shown)

The Land Rover branded waterproof rubber mat helps to protect the rear cargo space carpet from general dirt.



Passenger Footwell Net
VPLRS0362PVJ – Ebony
VPLRS0461AAM – Espresso (not shown)

Easily accessible by the passenger, the passenger footwell net provides additional storage space within the cabin, ideal for everyday small items such as maps and letters.



Mudflaps
VPLRP0283 – Front
VPLRP0357 – Rear

Mudflaps are a popular upgrade for reducing spray and ensuring paintwork is protected from debris and dirt. Engineered to complement the vehicle exterior design.



Rubber Floor Mats
VPLRS0333PVJ – Ebony
VPLRS0333AAM – Espresso (not shown)

Rubber footwell mats help provide protection from general dirt.

OTHER



iPhone® Connect and Charge Dock
VPLRV0119

The iPhone connect and charge dock has been designed to allow visibility of the phone while charging, utilizing the cupholder space in the central console. When connected the iPhone media is accessible and has the ability to be controlled via the integrated infotainment system. The iPhone USB charger can be easily disconnected if the USB connection is required for other use. For use with iPhone 5, 5c, 5s, 6 and 6s.



Wireless Phone Charging Cupholder**
VPLRV0118

The wireless phone charging cupholder has been designed to allow visibility of the phone while charging, utilizing the cupholder space in the center console. The holder will accommodate phones up to 2.9" wide securely in place. The charger displays an LED light to indicate when charging, and turns off when complete.

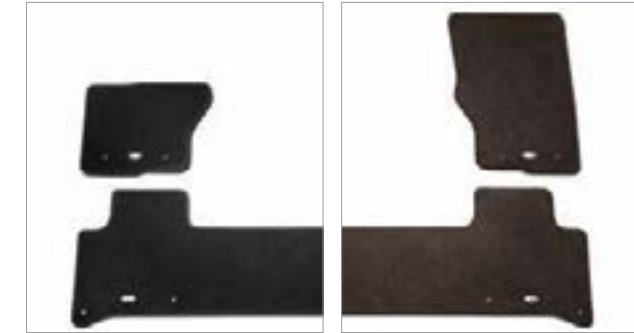

Luxury Carpet Mats
VPLRS0331PVJ – Ebony
VPLRS0331AAM – Espresso

Luxurious, tailored, deep pile 72.3 oz. carpet mat set, with Land Rover ingot branding and waterproof backing, provide a well appointed finishing touch to the interior.



Snow Traction System
VPLGW0081

Snow traction system is designed to give improved steering and braking control on snow and ice, when fitted to front wheels. Easy-fit design, manufactured from high quality hardened galvanized steel, the chains are supplied in a tough vinyl carry bag for storage when not in use. Suitable for 19-21" wheels.



Luggage Carrier¹
VPLRR0159

Flexible rack system to facilitate roof carrying. Maximum payload 134 lbs¹.



Wind Deflectors – Clear⁴
VPLRP0284

Wind deflectors for side windows to help to improve comfort levels in the cabin when driving with windows open, by reducing air turbulence and noise and allowing fresh air to be circulated in the cabin.

118 *Part numbers shown available with Three-zone and Four-zone Climate Control only. Also available for vehicles with Two-zone Climate Control, VPLRS0373PVJ – Ebony, VPLRS0373AAM – Espresso.

**The wireless phone charging cupholder does not provide a connection to InControl Apps. ¹Roof rails and cross bars are required for all Land Rover roof mounted accessories. Objects placed above the roof mounted satellite antenna may reduce the quality of the signal received by the vehicle and could have a detrimental effect on the navigation and satellite radio system, if fitted. ⁴Maximum payload equals the load capacity of the roof mounted accessory. ⁴Sold as a kit of four wind deflectors, two for the front door windows and two for the rear door windows. iPhone® is a registered trademark of Apple Inc. registered in the US and other countries.



ABOVE & BEYOND

CONTENTS

SPECIFICATIONS

FIND A RETAILER

BUILD YOUR OWN

TECHNICAL DETAILS

DIMENSIONS AND CAPABILITIES

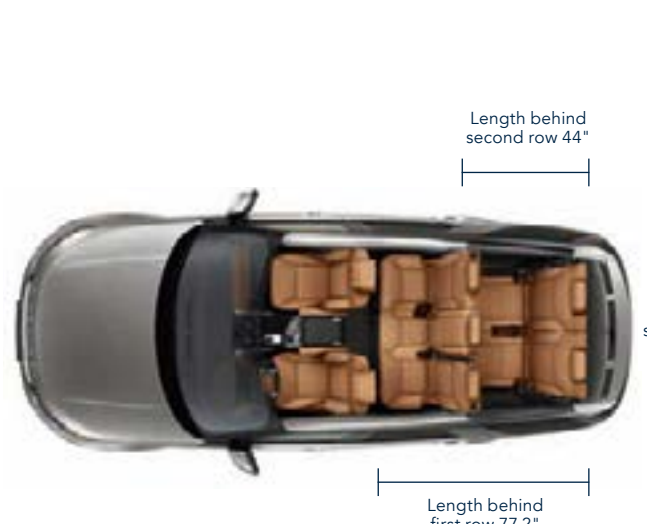

Standard Ride Height
With roof antenna 74.3"

Headroom
Maximum front headroom with panoramic sunroof 40"
Rear headroom 39"

Cargo Capacity
Rear seats upright
Height 36", Width 55"
Maximum cargo space volume 45 cu.ft.
Maximum length at floor 44"
Rear seats folded
Length behind first row 77.2"
Height 36", Width 55"
Maximum cargo space volume 82.7 cu.ft.
Maximum length at floor 77.2"

Obstacle Clearance
Air suspension 11.1"
Coil suspension 8.7"

Turning Circle
Curb-to-curb 40.4 ft.
Wall-to-wall 41.6 ft.
Turns lock-to-lock 2.7

Wading Depth*
Maximum wading depth
Air suspension 35.4"
Coil suspension 33.5"

Length behind second row 44"
Length behind first row 77.2"
Cargo space width 55.5"
Overall length 195.6"

Width 81.6" mirrors folded
Width 87.4" mirrors out

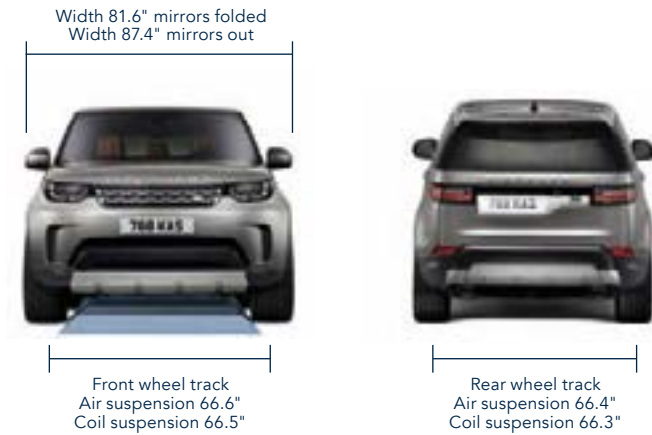

Front wheel track
Air suspension 66.6"
Coil suspension 66.5"

Rear wheel track
Air suspension 66.4"
Coil suspension 66.3"



	A	B	C
Ride Height			
Approach Angle	34.0°	27.5°	30.0°
Ramp Angle	29.0°	22.2°	27.0°
Departure Angle			



TECHNICAL SPECIFICATION, PERFORMANCE AND KEY DATA

	GASOLINE 3.0L Si6 AUTOMATIC	DIESEL 3.0L Td6 AUTOMATIC
POWER (HP)	340	254
Seats	5 / 7	5 / 7
ENGINE DATA		
Power (hp @ rpm)	340 / 6,500	254 / 3,750
Torque (lb/ft @ rpm)	332 / 3,500-5,000	443 / 1,750-2,250
Capacity (cc)	2,995	2,993
No. of cylinders	6	6
Valves per cylinder	4	4
Cylinder layout	Longitudinal V6	Longitudinal V6
BRAKES		
Front type	Brembo P4 caliper	2 x 48mm sliding fist caliper
Front diameter (inches)	14.2	14.2
Rear type	43mm sliding fist caliper	45mm sliding fist caliper
Rear diameter (inches)	13.8	13.8
Park brake	Integrated motor-on caliper	Integrated motor-on caliper
WEIGHT (LBS)		
Unladen Weight	4,901	5,066
Gross vehicle weight	6,592 / 6,900	6,724 / 6,989
TOWING (LBS)		
Unbraked trailer	1,653	1,653
Maximum towing	8,201	7,716
Maximum coupling point**	771	771
ROOF CARRYING (LBS)		
Maximum roof load (including roof rack weight)	176	176
PERFORMANCE		
Maximum speed ¹ (mph)	130	130
Acceleration ¹ (secs) 0-60mph	6.9	7.7
Fuel tank capacity – usable (US gallons)	23.5	22.5
Diesel Particulate Filter (DPF)	-	■

*These systems are not a substitute for driving safely with due care and attention and will not function under all circumstances, speeds, weather and road conditions, etc. Driver should not assume that these systems will correct errors of judgment in driving. Please consult the owner's manual or your local authorized Land Rover Retailer for more details. Maximum approach, ramp and departure angles with air suspension in off-road height with the front tow eye cover removed. Vehicles shown are HSE Luxury in Silicon Silver.

■ Standard – Not Available.
**With electrically deployable tow bar. ¹Always follow local speed limits.
Maximum approach, ramp and departure angles with air suspension in off-road height with the front tow eye cover removed.

Visit landroverusa.com to configure your vehicle online. 121



ABOVE & BEYOND

CONTENTS

SPECIFICATIONS

FIND A RETAILER

BUILD YOUR OWN

A WORLD OF LAND ROVER



LAND ROVER EXPERIENCE

Ever since its inception, Land Rover has been ready for anything. Its legendary capability has seen it tackle the most demanding of terrains, in the most difficult conditions. Its versatile interior has become synonymous with comfort and greater cargo space. And its 'can do' attitude has made it the most welcome of vehicles across the globe.

You can be part of the Land Rover story at one of our Land Rover Experience Centers. You can see how each and every one of these iconic vehicles is built. You can take one out onto off-road tracks where your driving skills will be put to the test. Or you can go even further on one of our Adventure Travel holidays to such countries as Tanzania, Iceland or Morocco.

Adventure awaits.

For more information, visit landroverusa.com



LAND ROVER ONELIFE

Onelife, the award-winning Land Rover magazine, is published twice a year and reaches customers in 40 countries. Each issue is filled with the latest Land Rover news and vehicles, insights into the technology and design that shape each vehicle, inspirational journeys and opinions from international experts.



LAND ROVER FINANCIAL SERVICES

Getting the keys to your very own Land Rover has never been so simple. And it's more affordable than you might think. New or used, for personal or business use, we have an option that puts you in complete control. Please speak to your nearest Land Rover Retailer to find out more.

For more information, visit landroverusa.com

FLEET & BUSINESS

Land Rover is dedicated to being the premium manufacturer of choice for fleets and businesses, by providing a highly attractive range of vehicles and exemplary customer service.

Distinctive, capable and versatile, all Land Rover vehicles deliver low total cost of ownership through strong residual values, competitive service, maintenance and repair costs.

We are also committed to providing a totally customer focused aftersales service, which will ensure every Land Rover vehicle is kept on the road and in top condition, in the easiest and most cost-efficient way for businesses.

For more information, visit landroverusa.com



LAND ROVER COLLECTION

The vehicle is just the beginning. The latest Land Rover Collection is now available for you to discover.

A meticulous attention to detail doesn't stop with our vehicles. You'll find the same level of craftsmanship in all of our clothing, travel items and premium gift ideas. So whether you're shopping for yourself or a loved one, you know the quality is assured.

The Land Rover Collection includes ladies and mens clothing, an extensive range of small leather goods such as wallets, portfolios, iPad and iPhone cases along with briefcases and weekender bags. A range of cufflinks and ladies silk scarves add a luxury feel to the collection. There's a kids collection too, with colorful fun clothing, caps and replica model vehicles for them to enjoy.

Visit shop.landroverusa.com to browse the Land Rover Collection.



ROADSIDE ASSISTANCE

Land Rover Optimized Assistance provides help in motoring emergencies, from immobilization due to breakdown or accident to minor problems such as punctures. You can rely on our roadside assistance, whatever the situation, anywhere in North America during the vehicle warranty period.

For further details please contact your nearest Land Rover Retailer or visit landroverusa.com

IMPORTANT NOTICE: Jaguar Land Rover Limited is constantly seeking ways to improve the specification, design and production of its vehicles and alterations take place continually. While every effort is made to produce up to date literature, this brochure should not be regarded as an infallible guide to current specifications, nor does it constitute an offer for the sale of any particular vehicle. Distributors and Retailers are not agents of Jaguar Land Rover Limited by any express or implied undertaking or representation.

All Land Rover Approved Accessories fitted by a Land Rover Retailer within one month or 1,000 miles (which ever occurs first) of the handover of a new registered vehicle will benefit from the same warranty terms and period of cover as the vehicle warranty. Accessories purchased outside of these parameters will be subject to a 12 month unlimited mileage warranty. All Land Rover Approved Accessories are rigorously tested to the same exacting standards as those applied to our vehicles. Performance in extreme hot and cold temperatures, corrosion resistance, impact and airbag deployment highlight some of the exhaustive product testing carried out to ensure accessories are both durable and importantly, continue to comply with current legislation. Some of the accessories featured are not available on all models. Please consult your nearest Land Rover Retailer for more information.

All our accessories are designed to be an integral part of Land Rover vehicles. While many items such as roof carriers are simple to fit, some products require specialist tools and diagnostic equipment to ensure correct integration with the vehicle structure and electrical systems. These products vary from market to market, please consult your Land Rover Retailer who will be pleased to advise you on current specifications and any query you may have.

The colors reproduced here are subject to the limitations of the printing process and may therefore vary slightly from the actual vehicle. The company reserves the right to alter or withdraw any color finish without notice. Some of these colors may not be obtainable in your country. Please check availability of colors and current specifications with your Land Rover Retailer. Distributors and retailers are not agents of Jaguar Land Rover Limited and have absolutely no authority to bind Jaguar Land Rover Limited to any express or implied undertaking or representation.

Castrol EDGE Professional recommended by Land Rover.

Vehicle shown on front and back cover is HSE Luxury in Namib Orange.

Jaguar Land Rover North America, LLC
555 MacArthur Boulevard
Mahwah, NJ 07430-2327

landroverusa.com

© 2017 Jaguar Land Rover North America, LLC
Publication Number:
1L4621810CCSBUSEN01P



ABOVE & BEYOND

