

# L A S E R

## PLYMOUTH



PATTERSON - CHRYSLER - PLYMOUTH  
JEEP - EAGLE  
1965 N. Ellsworth Ave.  
Salem, Ohio 44460  
216-337-3475



# P L Y M O U T H

## *Safety is Laser's most important feature*

Your car should help protect you wherever you go. Plymouths do. We've received numerous letters from owners across the country attesting to the fact that our safety features help save lives.

**Front motorized passive restraint system** with manual active lap belts, standard, offers safety for driver and passenger.

**Three-point Unibelt restraint system**, standard, provides outboard rear seat passengers with additional protection.

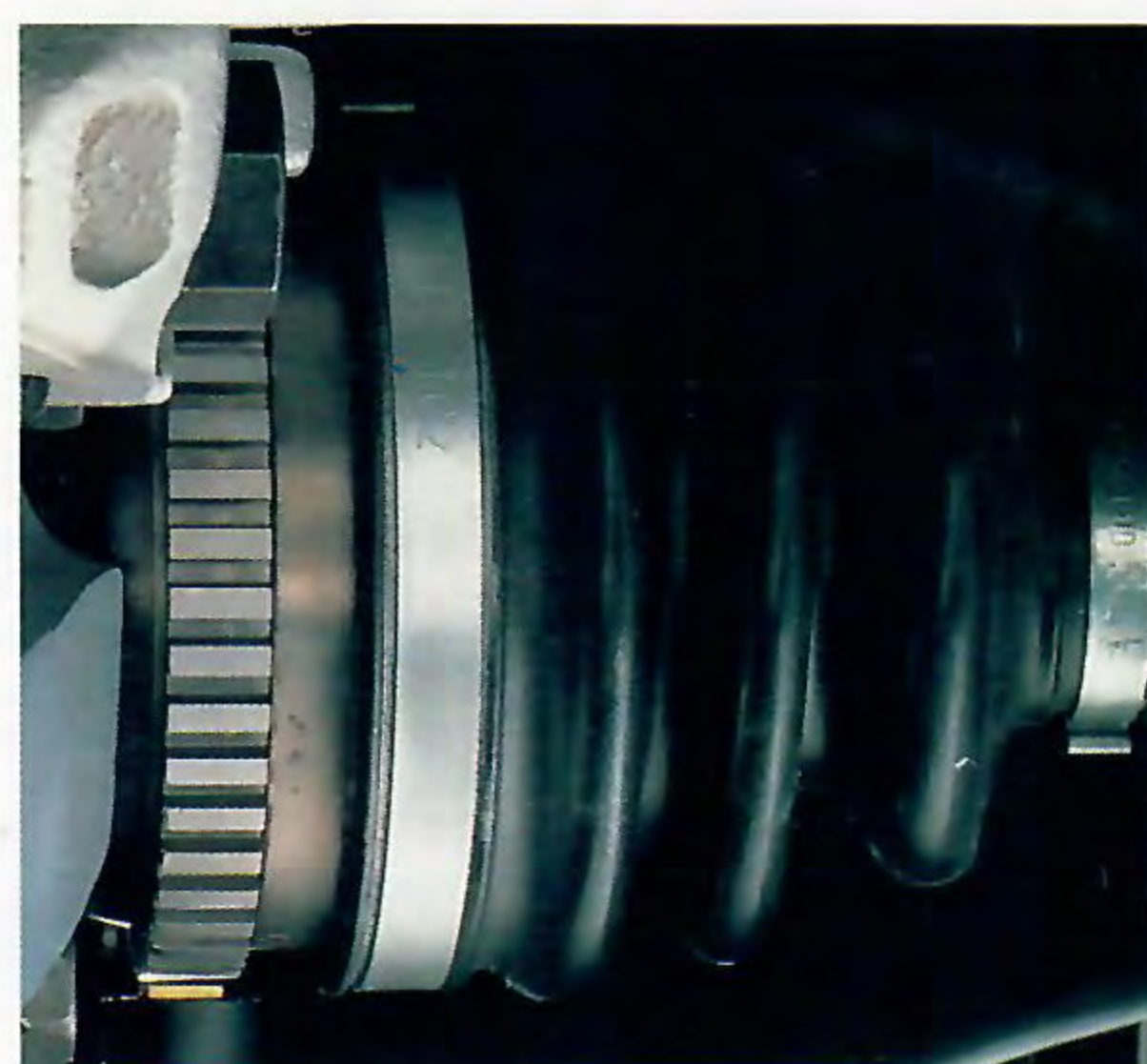

**Four-wheel antilock brakes** improve stability by helping to prevent wheel lockup when braking on wet or slippery surfaces. (Available on Laser RS and RS Turbo. Restrictions apply.) **Four-wheel disc brakes** for sure-footed stopping are standard on all Laser models.

**Side door beams**, standard on all Laser models, offer extra protection in side impacts.

**Advantage: Plymouth Safety**

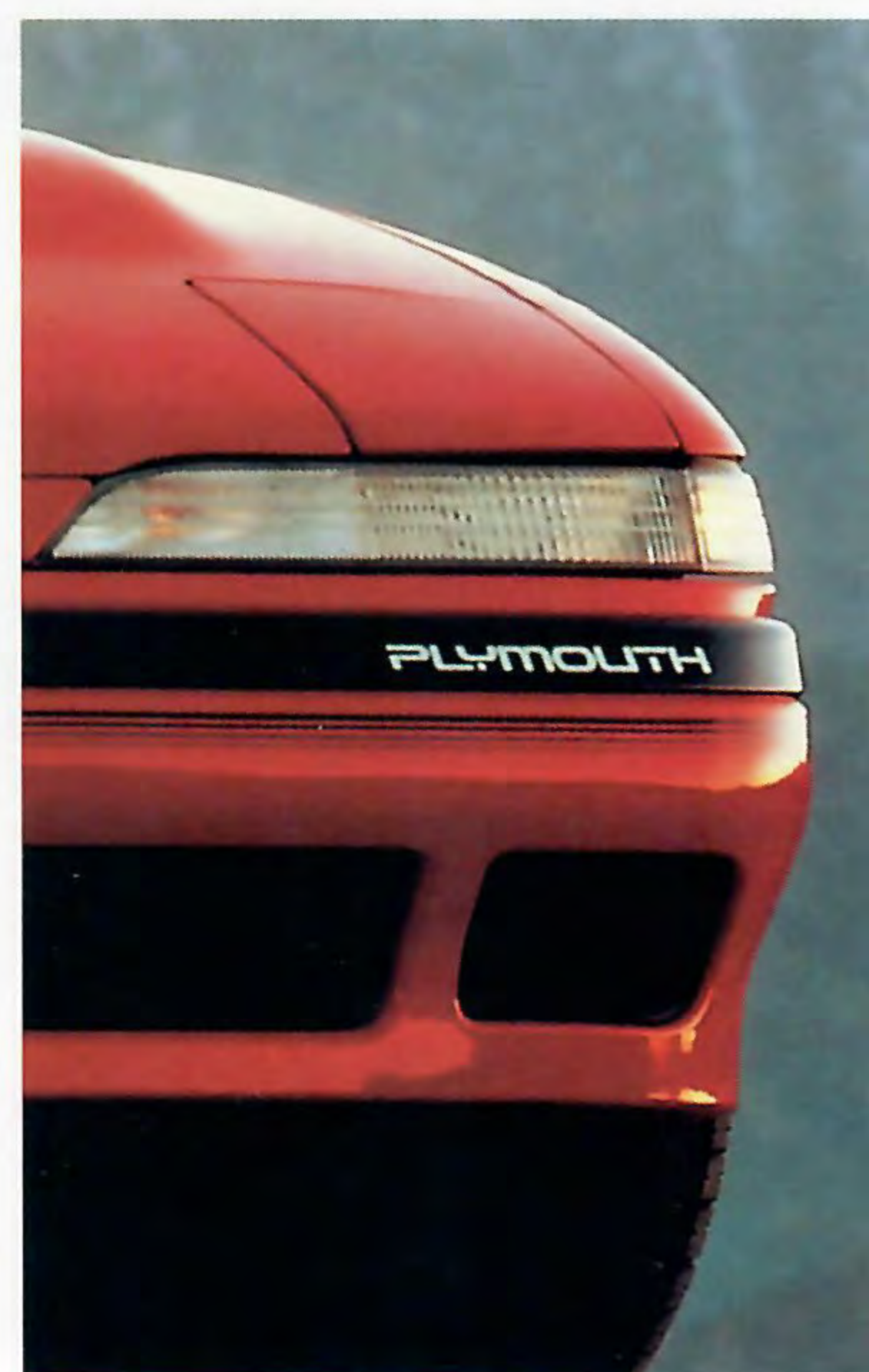

**Energy-absorbing five-mph front and rear bumpers**, standard, exceed the protection required by federal law.

**Power door lock** option provides extra security from the driver's seat. (Laser RS and RS Turbo only.)

**Security alarm system** option provides a pocket-size remote door lock/unlock, panic button, and much more. (Dealer supplied/installed.) **Alarm system** option blinks headlights and sounds horn intermittently when car is forcefully entered. (Factory installed. Restrictions apply.)

**Portable handheld cellular telephone** offers finger-tip communications should you need roadside assistance. (Dealer supplied option. See page 17 for additional information.)

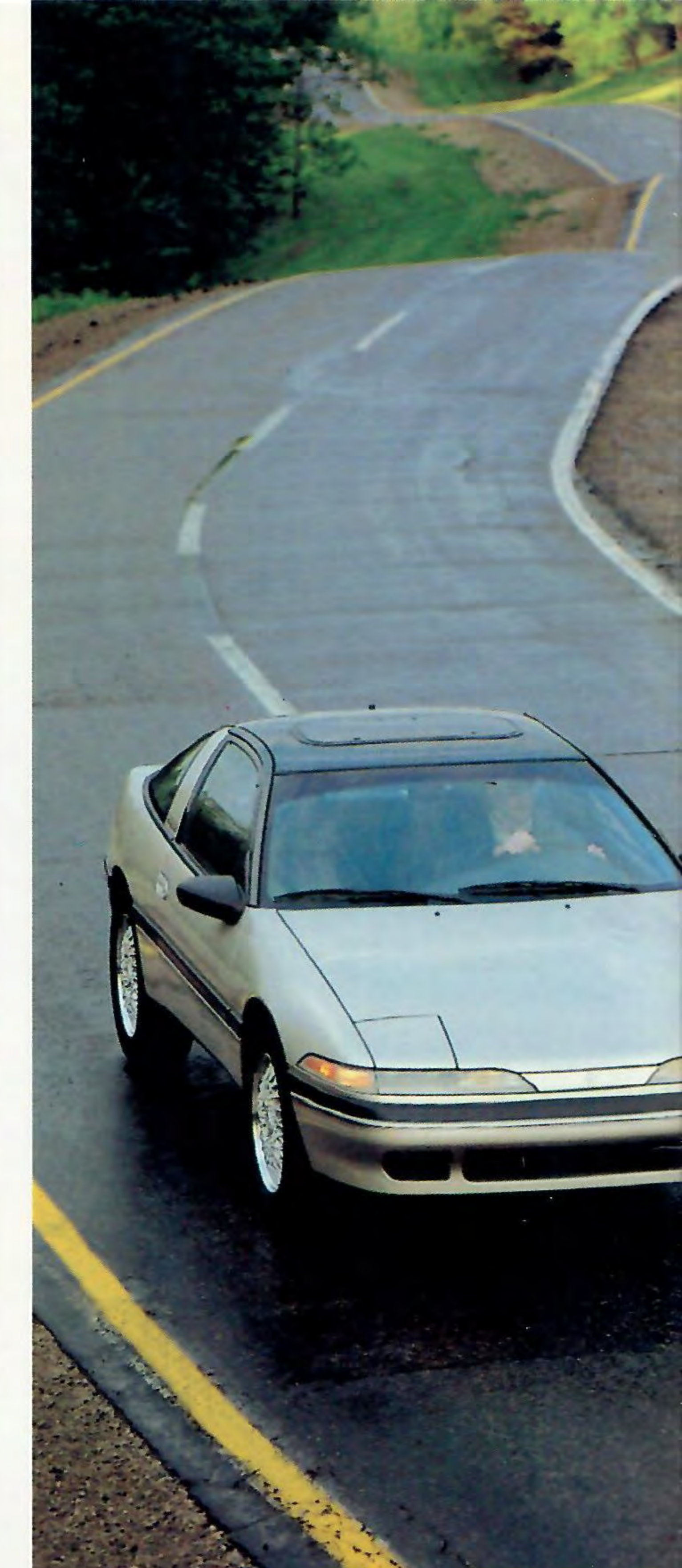
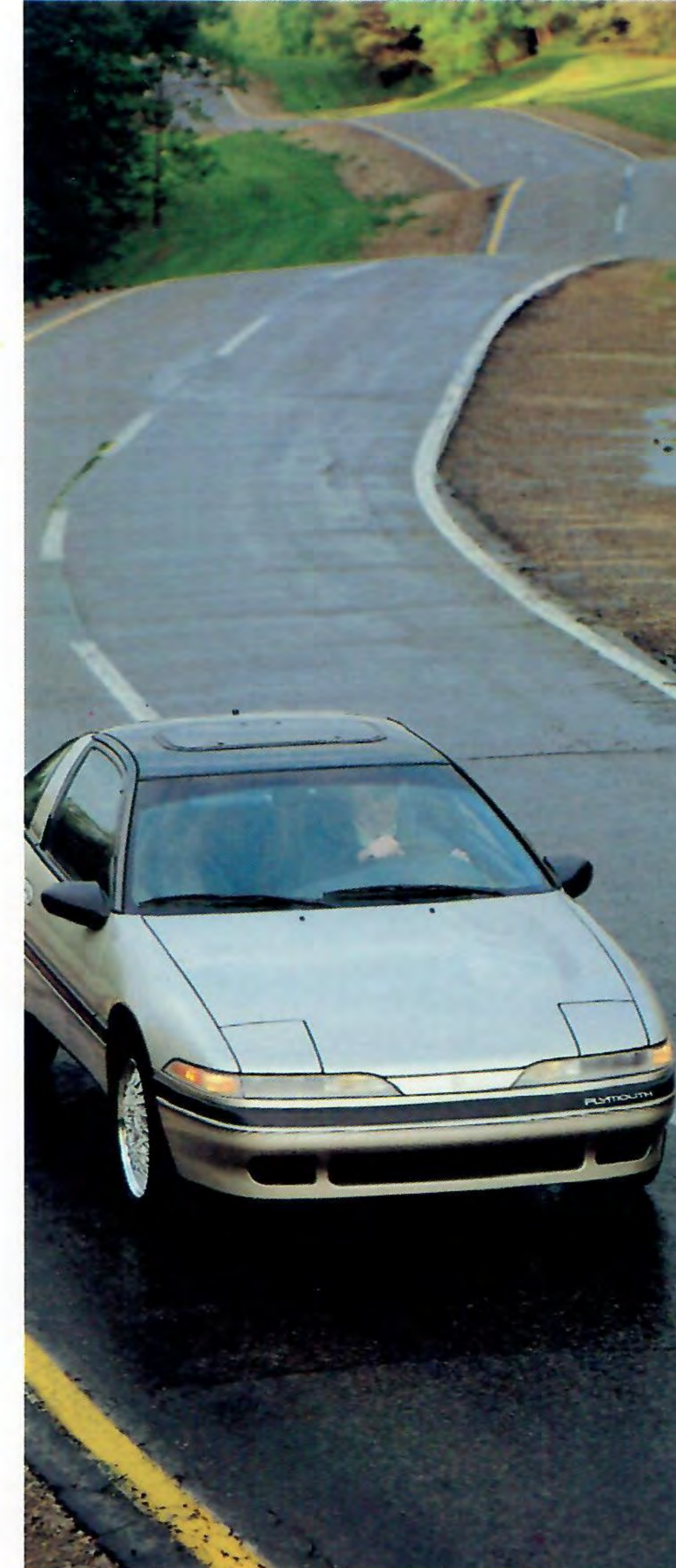

## *The style and power of a rousing performance*

**About this catalog.** We have tried to make this catalog as complete as possible. However, since the time of printing, some of the information you'll find here may have been updated. Your dealer has details, and you should ask him for current information before ordering.

Some of the equipment shown or described throughout this catalog is available at extra cost.

*Shown right: Plymouth Laser RS Turbo in Electric Blue Metallic Clear Coat.*

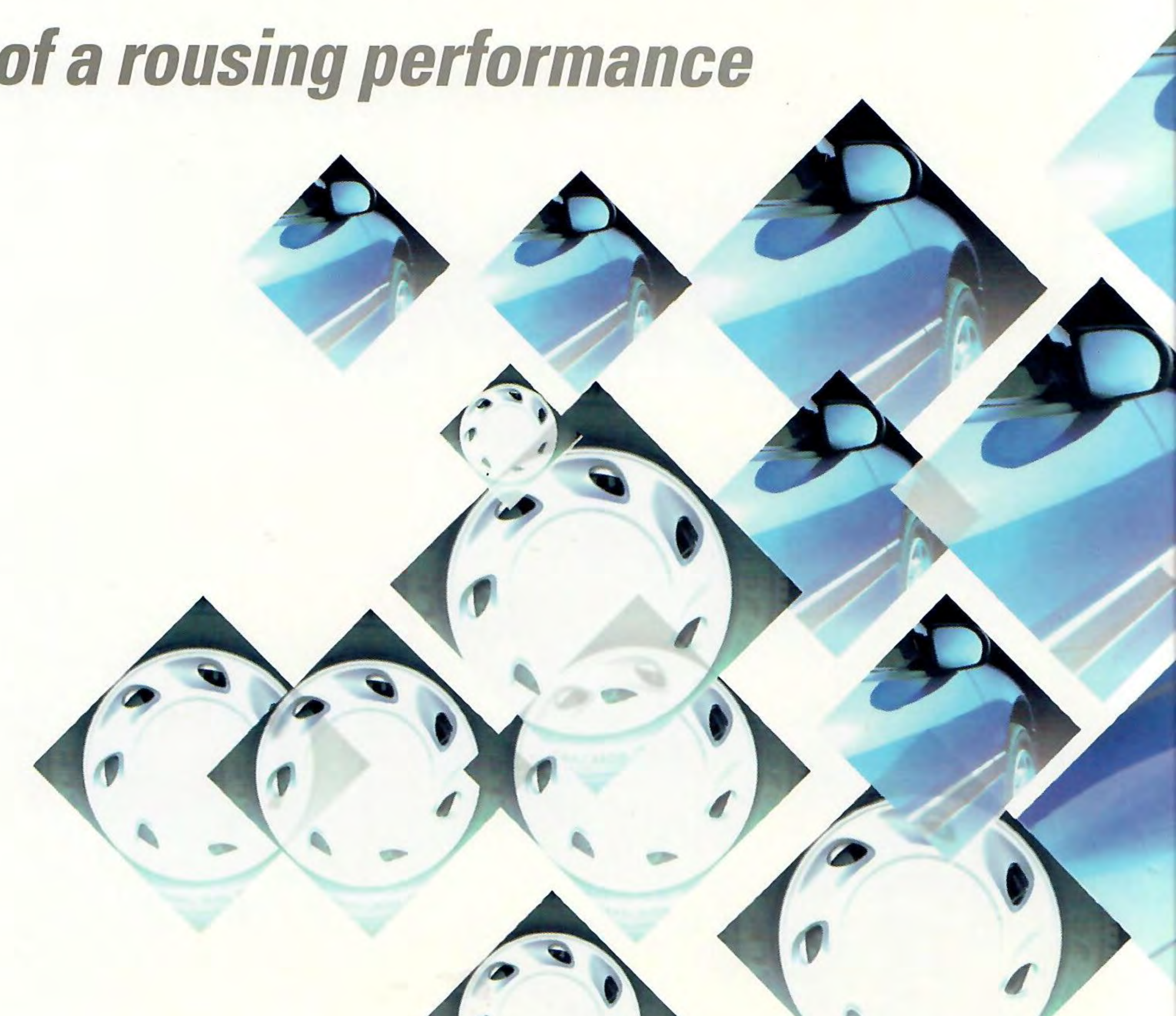



The 1991 Plymouth Laser is absolutely the hottest sports coupe in its class. The RS Turbo model delivers 0-60 in 6.6 seconds.\* Advanced engineering includes available four-wheel antilock brakes†, road-hugging agility, over 40 standard features, and the ultimate cockpit interior. All at an affordable price. Advantage: Plymouth. No wonder *Car and Driver* magazine honored Plymouth Laser RS Turbo with its "10 best" award two years in a row.‡

# L A S E R





# L A S E R R S T U R B O

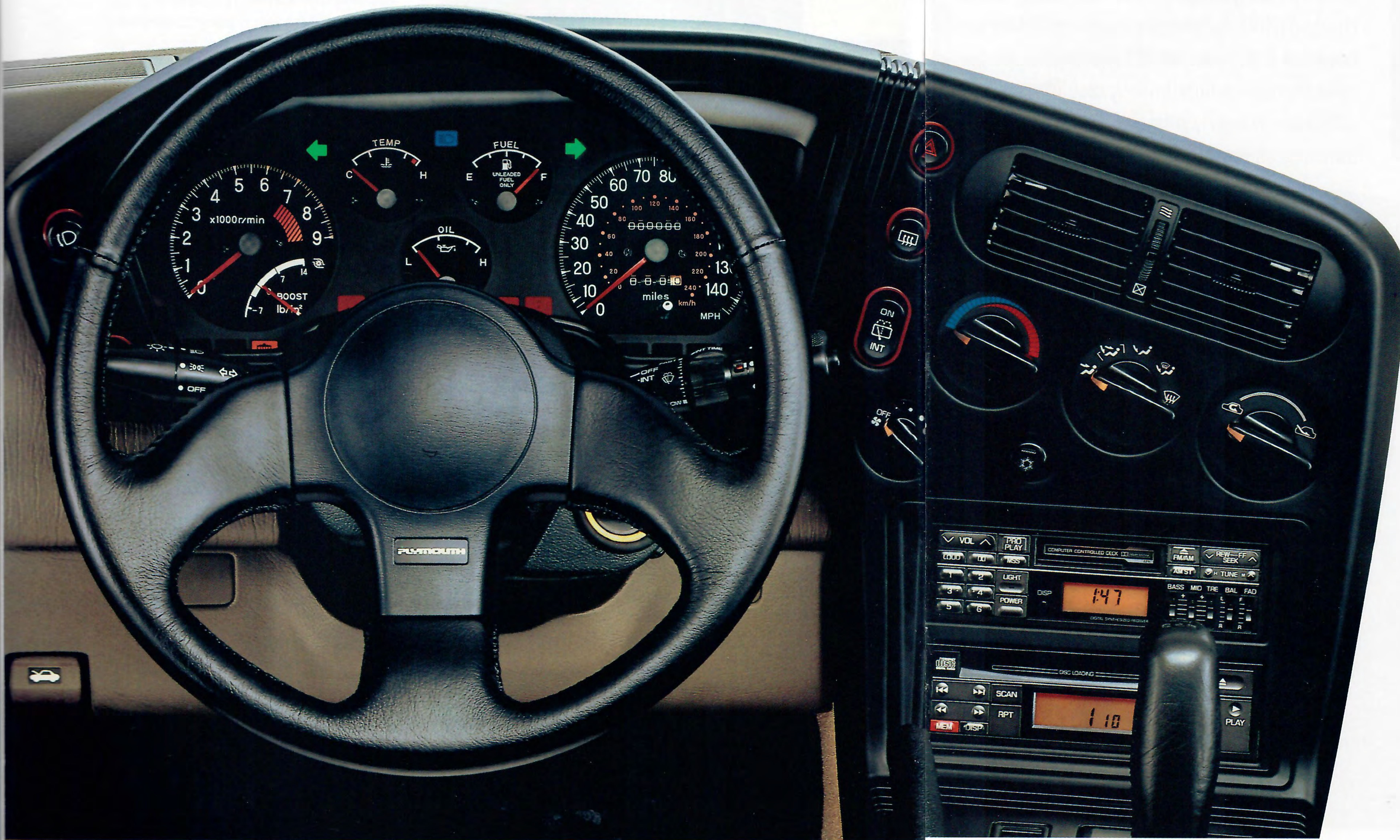

*A high-tech interior that puts you in full charge*

Laser RS Turbo's wraparound cockpit submerges you in a driving environment of total control and convenience. Includes leather-wrapped sport steering wheel, Eurostyle heat/vent controls (air conditioning optional), available AM stereo\*/FM stereo electronically tuned radio/cassette player with compact disc player, and much more. Laser RS Turbo interior offers body-hugging cloth high-back bucket seats with adjustable driver-side lumbar support.

\*Some AM stereo broadcasting may not be compatible with this radio.



R S

**Laser RS Turbo  
Leaves the competition  
standing still**

Some things in life just can't wait. Owning a Plymouth Laser RS Turbo is one of them. At its heart is a 2.0-liter DOHC (dual overhead cam) 16-valve intercooled turbocharged MPI engine that pumps out 190 horsepower at 6,000 rpm. DOHC and four valves per cylinder deliver outstanding smoothness and efficiency. A newly refined five-speed manual transaxle shift mechanism puts a firm "feel and

T U R B O

throw" in your grasp. Performance-tuned front independent MacPherson-type struts paired with trailing beam rear suspension design let you charge into turns with precise handling control. Newly available for 1991 ... four-wheel antilock disc brakes, and a four-speed electronically controlled automatic transaxle. Plymouth Laser RS Turbo, shown in Black Clear Coat.

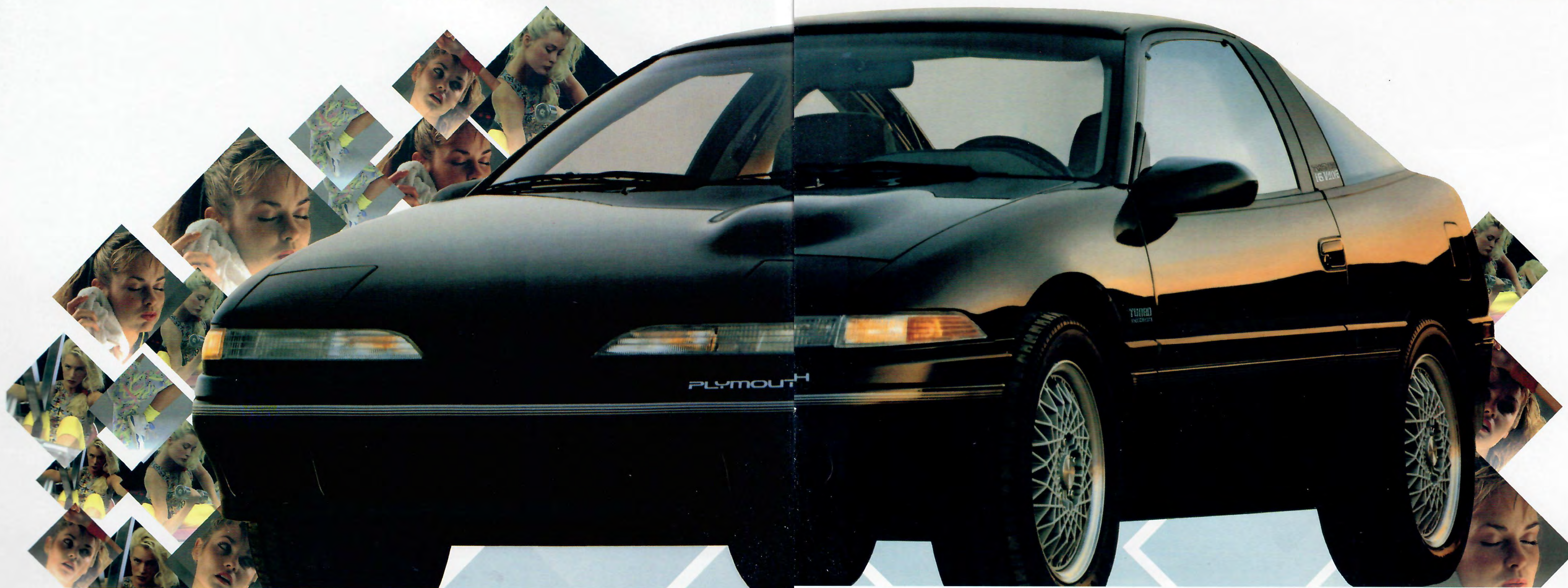
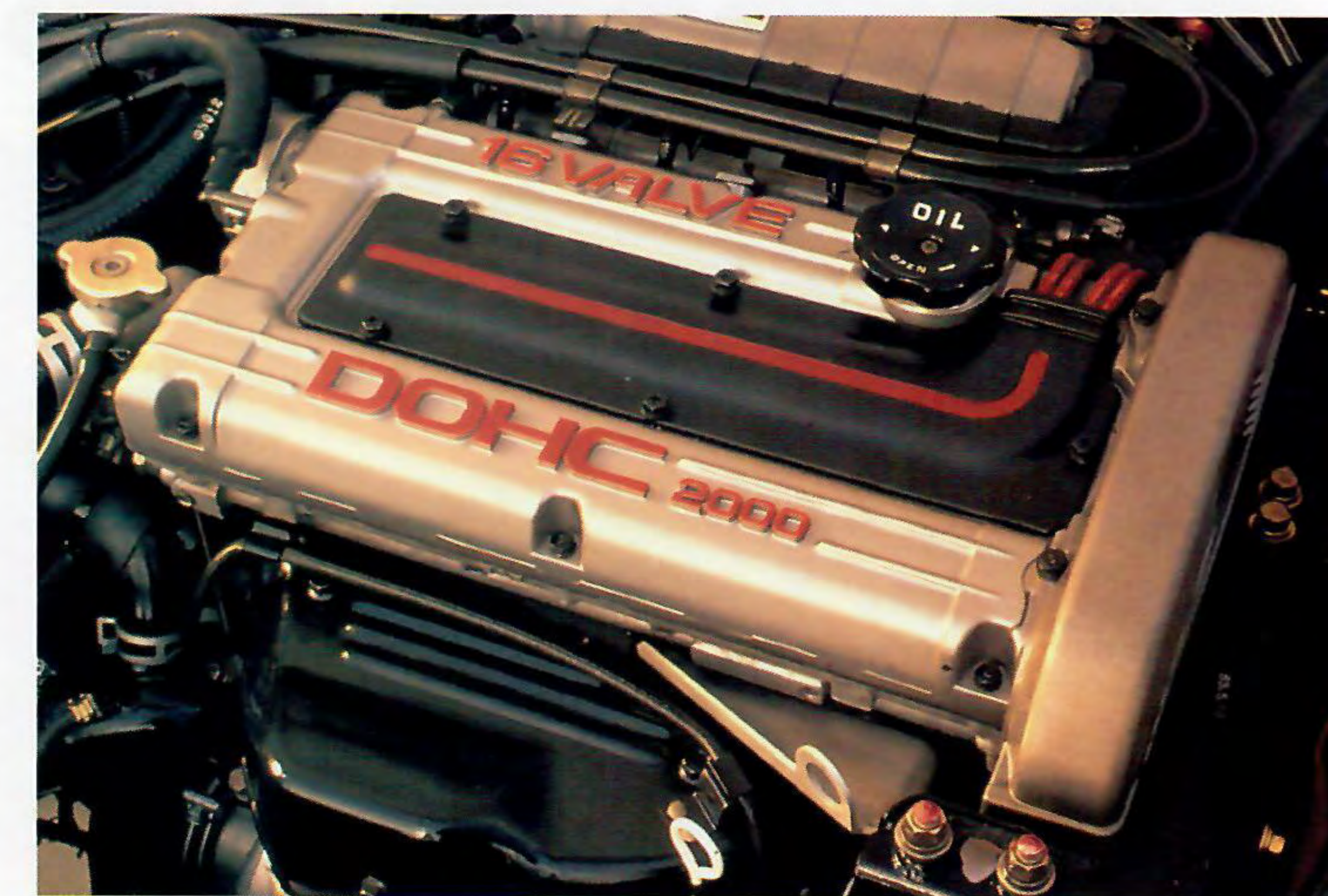



L A S E R

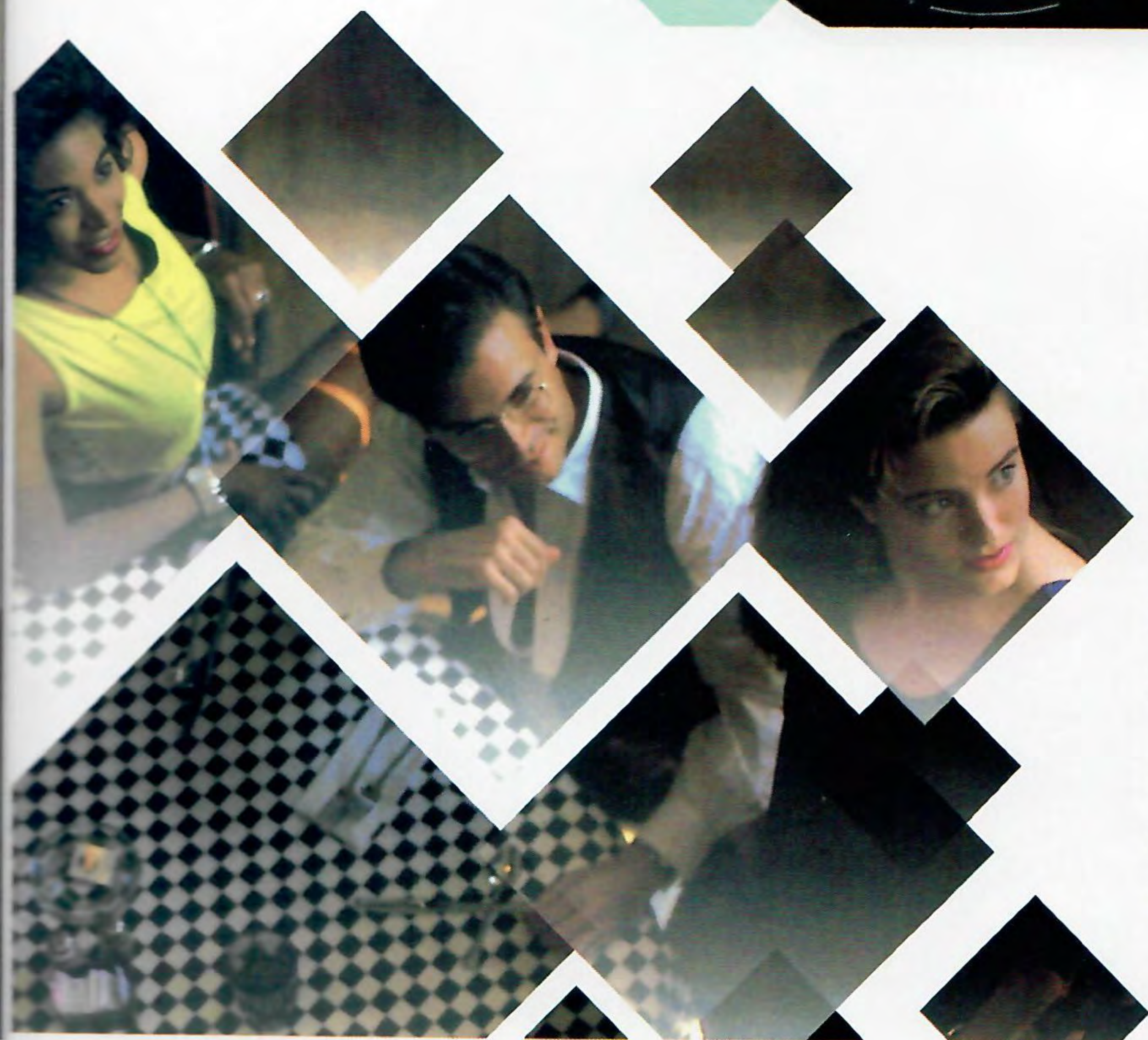
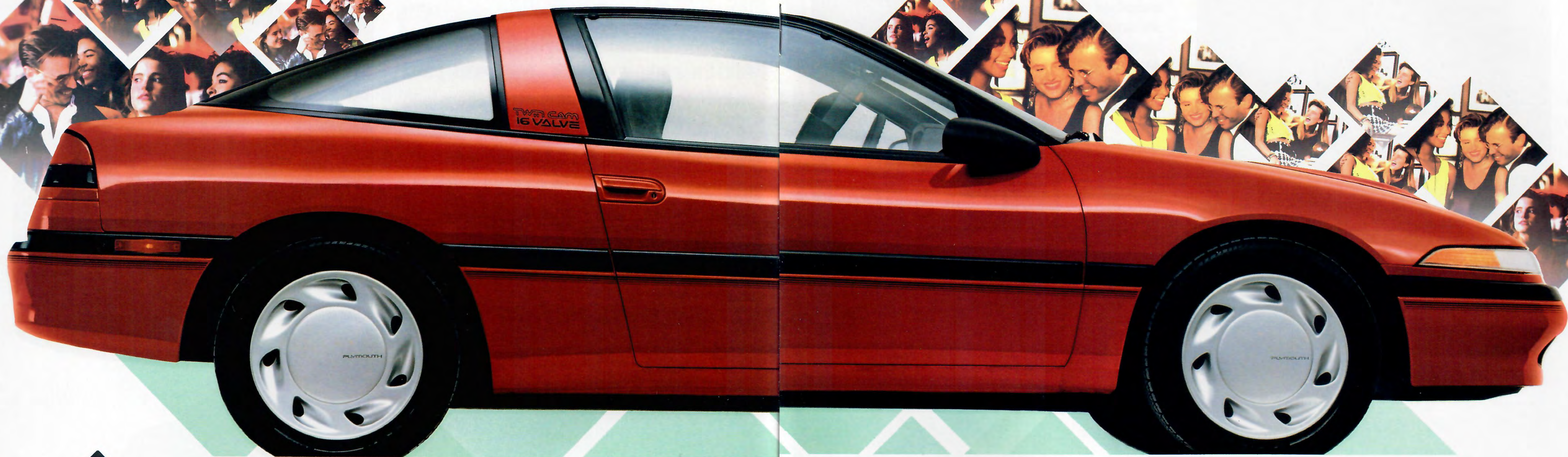

### *Exciting from the word go*

Sharp looks and a sleek aeroshape. Plymouth Laser RS is uninhibited, flat-out fun. Standard features just begin with an aggressive 2.0-liter DOHC 16-valve MPI engine, power-assisted four-wheel disc brakes and rack-and-pinion steering, full center console, and new split fold-down rear seats. The entry-level Plymouth Laser delivers smooth and responsive

L A S E R



power with a standard 1.8-liter SOHC (single overhead cam) MPI engine. And all Lasers offer a longer power train limited warranty and anti-corrosion limited warranty than any other car in their class.\* Advantage: Plymouth. Laser RS, shown above in Flash Red Clear Coat. Laser, shown right in Light Spectrum Blue Metallic Clear Coat.

\*Based on 1990 competitive warranty coverage.

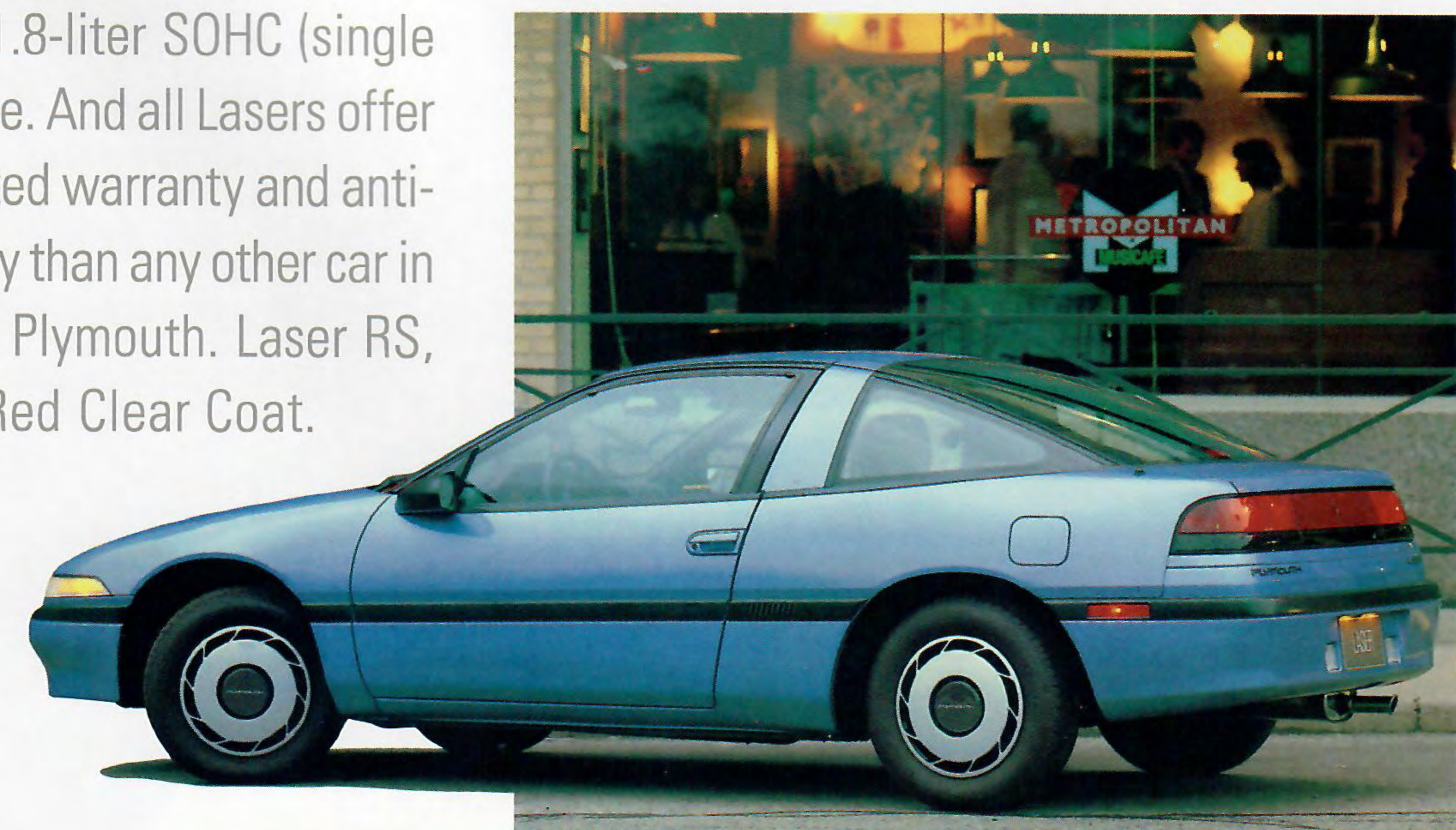



# SAFETY • ENGINEERING FEATURES • OPTIONS



**1 Motorized passive restraint system** with manual active lap belts in front and rear lap/shoulder belts holds occupants comfortably for added safety.

**Available portable handheld cellular telephone** offers a wide range of features which are easily accessed through user-friendly menus. (See page 17 for additional information.)

**5 Energy-absorbing five-mph front and rear bumpers** exceed the protection required by federal law.



**6 Electronically controlled four-speed automatic transaxle** is now available on all Laser models. Includes an electronically controlled lockup torque converter plus "Economy" and "Power" modes that change shift points to conserve fuel or maximize performance.



**New driver-side map pocket** holds road maps and important papers within easy reach. (Available on Laser RS and RS Turbo with power windows only.)

**New security alarm system** (not shown) gives you protection and peace of mind. Features a pocket-size remote door lock/unlock, interior illumination mode and a panic button for personal protection. A "kill switch" that interrupts the engine ignition circuit is also included. (Power locks required. See dealer for availability.)

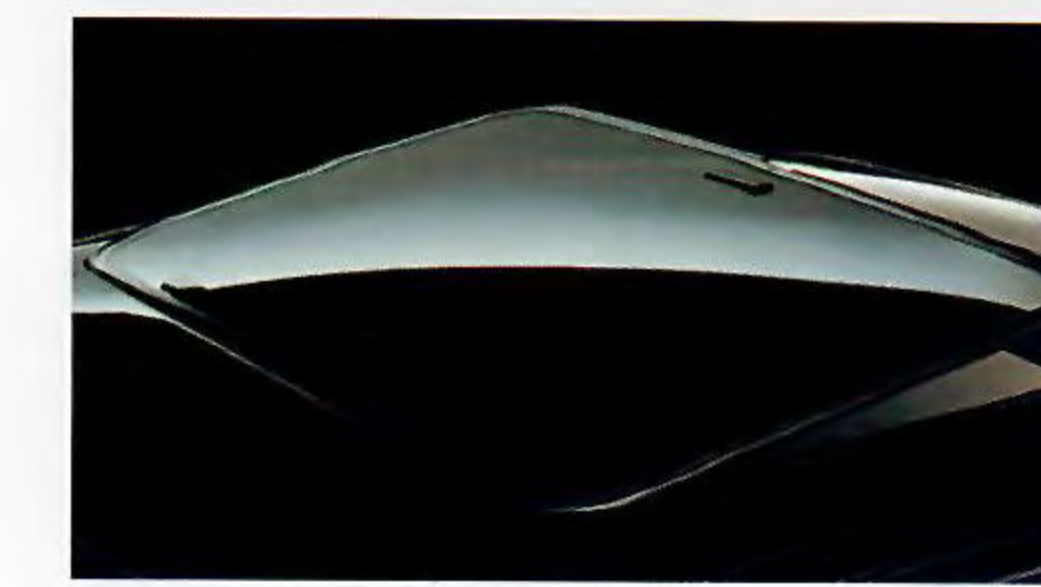

**Flip-up/removable sunroof** includes air deflector, sunshade, vinyl protective storage bag, and cargo compartment tie-down straps.



**New split fold-down rear seats** offer added cargo-handling versatility and over 25 cubic feet of room when reclined. (All-cloth on Laser RS and RS Turbo.)

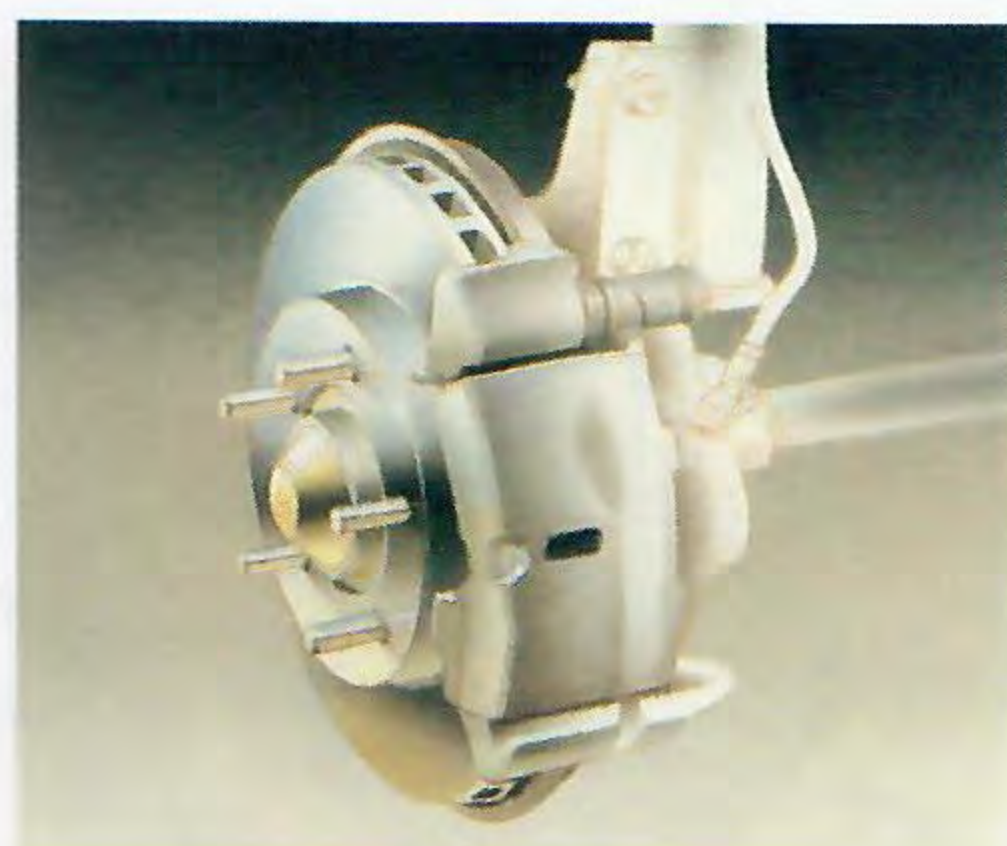

**2 Available four-wheel antilock brakes** are electronically controlled and improve stability by helping to prevent wheel lockup when braking on wet or slippery surfaces. (Available on Laser RS and RS Turbo. Restrictions apply.)

**3 Stainless steel exhaust system** is standard on all Laser models and offers durability as well as long life.



**4 Innovative four-valves-per-cylinder design** on Laser RS and RS Turbo increases power and efficiency for smooth, low-friction engine operation.

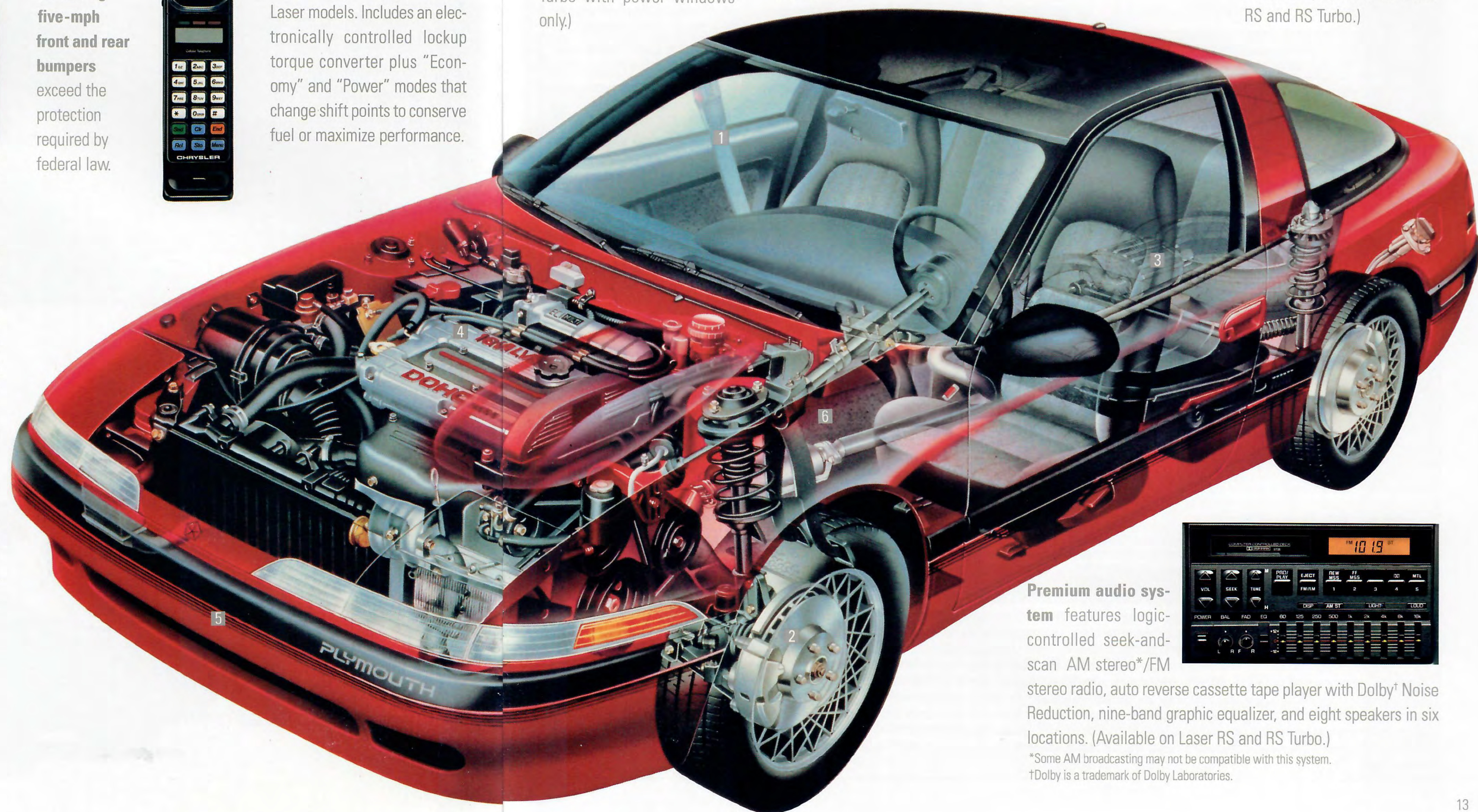

**Premium audio system** features logic-controlled seek-and-scan AM stereo\*/FM stereo radio, auto reverse cassette tape player with Dolby<sup>†</sup> Noise Reduction, nine-band graphic equalizer, and eight speakers in six locations. (Available on Laser RS and RS Turbo.)

\*Some AM broadcasting may not be compatible with this system.  
 †Dolby is a trademark of Dolby Laboratories.



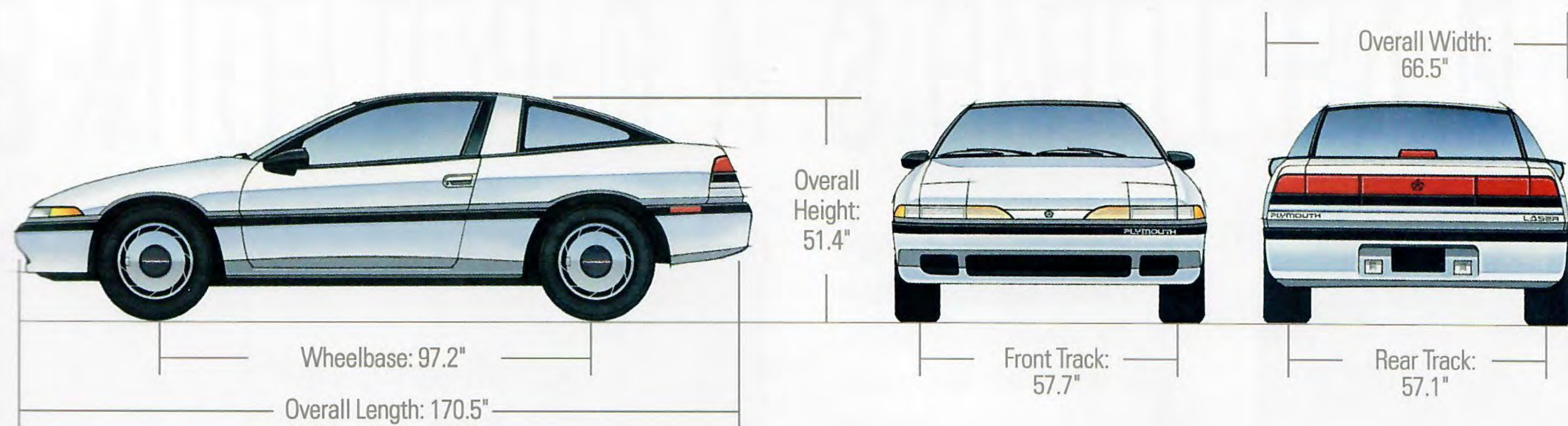

DIMENSIONS

EXTERIOR	
Overall Height (in.)	51.4
Overall Width (in.)	66.5
Overall Length (in.)	170.5
Wheelbase (in.)	97.2
Rear Track (in.)	57.1
Front Track (in.)	57.7
INTERIOR	
Head Room—Front (in.)	37.9
—Rear (in.)	34.1
Leg Room—Front (in.)	43.9
—Rear (in.)	28.5
Shoulder Room—Front (in.)	53.9
—Rear (in.)	52.4
Hip Room—Front (in.)	55.1
—Rear (in.)	45.7

SPECIFICATIONS

Turning Diameter (curb-to-curb)	
— Base Laser (ft)	34.1
— Laser RS, RS Turbo (ft)	35.4
Curb Weight (lbs) (with standard transaxle)	
Laser	2,524
Laser RS	2,678
Laser RS Turbo	2,745
Cargo Capacity (cu ft) <sup>1</sup>	10.2
Passenger Capacity	4
Fuel Capacity (gal)	15.8

<sup>1</sup>With rear seat down, cargo capacity is 25.7 cu ft.

POWER TRAIN CHART<sup>1</sup>

TYPE	DISPLACEMENT	BORE & STROKE	COMPRESSION RATIO	HORSEPOWER/TORQUE		TRANSAXLE AVAILABILITY
				SAE NET @ RPM		
4-cylinder SOHC MPI <sup>2</sup> : standard Laser only	1.8-liter (107 CID)	3.17" x 3.39"	9.0:1	92 hp @ 5,000	105 lb-ft @ 3,500	5-speed close-ratio manual overdrive (3.27 OTGR): standard 4-speed electronically controlled automatic (2.75 OTGR): optional
4-cylinder DOHC 16-valve MPI <sup>2</sup> : standard Laser RS only	2.0-liter (122 CID)	3.35" x 3.46"	9.0:1	135 hp @ 6,000	125 lb-ft @ 5,000	5-speed close-ratio manual overdrive (3.27 OTGR): standard 4-speed electronically controlled automatic (2.75 OTGR): optional
4-cylinder <sup>3</sup> DOHC 16-valve MPI turbocharged with intercooler <sup>2</sup> : standard Laser RS Turbo only	2.0-liter (122 CID)	3.35" x 3.46"	7.8:1 (11.1 psi max <sup>4</sup> boost pressure)	190 hp @ 6,000	203 lb-ft @ 3,000	5-speed close-ratio manual overdrive (3.08 OTGR): standard 4-speed electronically controlled automatic (2.75 OTGR): optional

OTGR—Overall top gear ratio. <sup>1</sup>Emissions controls and testing required at extra cost on all vehicles registered in California. Not available otherwise. <sup>2</sup>Built by Mitsubishi Motors Corporation. <sup>3</sup>Premium unleaded fuel recommended. Trailer towing is not recommended for vehicles equipped with turbocharged engines. Such use may damage engine and invalidate warranty. <sup>4</sup>Boost pressure varies with engine loads and rpm.

STANDARD SAFETY FEATURES

- Antitheft trunk lock and door lock inner guards
- Backup lights
- Brake fluid pressure loss warning light (also serves as indicator when parking brake is applied)
- Double ball-joint rearview mirror mount
- Dual braking system with separate brake fluid reservoirs in the master cylinder
- Dual outside rearview mirrors
- Electric windshield washers
- Double Protection energy-absorbing five-mile-per-hour front and rear bumpers
- Energy-absorbing front seatbacks
- Energy-absorbing instrument panel and sun visors
- Energy-absorbing steering column
- Fade-resistant four-wheel disc brakes
- "Flash-to-Pass" optical horn
- Front seat head restraints
- Glare reduction measures for instrument panel, steering wheel, and windshield wipers
- Hazard warning flasher system
- Ignition and steering column lock
- Impact-actuated fuel supply shutdown relay
- Inside rearview mirror
- Interlocking door latches with driver manual override feature
- Key-left-in-ignition reminder
- Non-override passenger door lock
- Recessed inside door release handles
- Reinforced windshield header and roof
- Remote hatch release
- Resilient window crank knobs
- Safety-Rim wheels
- Seat belt reminder system
- Seatback latches on folding front seats
- Shatter-resistant glass
- Side door beams
- Side marker lights and reflectors
- Turn signals with lane-change feature
- Two-point motorized passive restraint system with color-keyed lap belt on driver and front passenger seats<sup>\*</sup>; three-point shoulder/lap belts for all other outboard passenger seats

FUNCTIONAL

	LASER	LASER RS	LASER RS TURBO
Antilock Brake System—Electronically controlled	NA	O <sup>1</sup>	O <sup>1</sup>
Brake—Parking: hand-operated, center console	S	S	S
Brakes—Four-wheel disc, vented front/solid rear: power-assisted	S	S	S
Emissions Controls and Testing—Required at extra cost on all vehicles registered in California (not available otherwise)	O	O	O
Engines and Systems—See Power Train Chart page 16	—	—	—
Exhaust System—Performance-tuned stainless steel	NA	S	S
Exhaust System—Stainless steel	S	NA	NA
Front-Wheel Drive	S	S	S
Fuel Tank—15.8-gallon	S	S	S
Headlights—Halogen: concealed with pop-up and auto-off features	S	S	S
Steering—Rack-and-pinion (23.8:1): manual	S	NA	NA
Steering—Rack-and-pinion (15.8:1): power-assisted	P	S	S
Suspension—Standard: front independent struts, link-type sway bar, and antidive geometry; rear trailing beam axle laterally located by a track bar, integral sway bar and shocks	S	S	S
Suspension—Sport: includes increased spring rates and shock damping, front and rear	NA	S	NA
Suspension—Performance: front includes increased spring rates, and a solid, double ball-joint linked sway bar; rear includes increased spring rates and shock damping	NA	NA	S
Tire—Spare: compact, limited service	S	S	S
Tires—P185/70R14 black sidewall, all-season (set of four)	S	NA	NA
Tires—P205/55HR16 black sidewall all-weather performance-handling (set of four)	NA	S	NA
Tires—P205/55VR16 black sidewall all-weather performance-handling speed-rated (set of four)	NA	NA	S

EXTERIOR

Corrosion Protection—Extensive use of galvanized steel and lower body antichip coating	S	S	S
Hood—Power dome	NA	S	S
Mirrors—Dual remote control: black	S	NA	NA
Mirrors—Dual power remote control: black	NA	S	S
Molding—Bodyside: 360° protective	S	S	S
Roof—Body color	S	NA	NA
Roof—Black with body color targa band	NA	S	S
Stripe—Lower bodyside	NA	S	S
Sunroof—Removable, flip-up: includes air deflector, sunshade, cargo compartment tie-down straps, and vinyl storage bag	O <sup>2</sup>	O	O
Wheels—Styled-steel 14-inch (set of four)	S	NA	NA
Wheel Covers—Deluxe 14-inch (set of four)	P	NA	NA
Wheel Covers—Turbine 16-inch (set of four)	NA	S	S
Wheels—Lace alloy 16-inch (set of four)	NA	O	O

S—Standard. O—Optional. P—Package only. NA—Not available.

<sup>1</sup>Antilock brakes require security alarm on RS Turbo and vice versa. Laser RS requires additional package to purchase antilock brakes. <sup>2</sup>Power locks required in order to purchase optional Security System with remote. See dealer for details and availability.

<sup>3</sup>Package required in order to purchase sunroof for base model.

<sup>4</sup>There are special engine cooling requirements for field-installed air conditioning. Failure to follow these requirements may invalidate warranty. See your dealer for details.

<sup>5</sup>Some AM stereo broadcasting may not be compatible with this radio.

INTERIOR

	LASER	LASER RS	LASER RS TURBO
Air Conditioning <sup>3</sup> —Manual with two-position compressor operation	O	O	O
Carpeting—Passenger and cargo area	S	S	S
Cellular Phone—Portable	O	O	O
Coin Box—Flocked lining	S	S	S
Console—Full center with storage bin	S	NA	NA
Console—Full center with armrest cover and storage bin	NA	S	S
Deck Lid Release—Cable-operated remote control	S	S	S
Defroster—Rear window: electric (required on all passenger vehicles registered in New York state)	O	S	S
Demisters—Side window	S	S	S
Door Trim—Deluxe, soft-feel	NA	S	S
Fuel Door Release—Cable-operated remote control	S	S	S
Glove Box—Locking	S	S	S
Heater and Defroster—With dual mode bi-level ventilation	S	S	S
Hood Release—Cable-operated remote control	S	S	S
Instrument Cluster—Analog speedometer; electromechanical: tachometer, odometer, trip odometer; gauges for engine coolant temperature, engine oil pressure, fuel level, and turbo boost gauge (if equipped); warning lights, and symbols for speed control "on," overdrive "off" (auto. transaxle only), door/liftgate ajar, turn signal indicator arrows, high beams "on", brake system failure, parking brake on, ABS warning (if equipped), check engine, low coolant level, electrical system, low fuel level, and seat belt reminder	S	S	S
Lights—Cargo area; cigar lighter, glove box, ignition, illumination delayed extinguish, overhead console	S	S	S
Map Pocket—Driver's door (when power windows and locks are ordered)	NA	P	P
Mirror—Rearview: day/night	S	S	S
Radio—AM/FM stereo: electronically tuned; four-speaker sound; integral digital clock	S	NA	NA
Radio—AM/FM stereo: electronically tuned; cassette tape player; eight speakers in six locations; integral digital clock	O	S	S
Radio—Premium AM stereo <sup>4</sup> /FM stereo: electronically tuned; nine-band graphic equalizer, cassette tape player with logic-controlled transport; eight speakers in six locations; integral digital clock	NA	P	P
Radio—Premium AM stereo <sup>4</sup> /FM stereo: electronically tuned; cassette tape player, compact disc player, eight speakers in six locations, integral digital clock, three-band graphic equalizer	NA	P	P
Restraint System—Front motorized passive shoulder belts with active lap belts; rear three-point active shoulder and lap belts	S	S	S
Seats—Front, high-back bucket: cloth; rear, split-folding: cloth and vinyl trim	S	NA	NA
Seats—Front, high-back bucket with driver-side adjustable lumbar support: cloth; rear, split-folding: cloth insert	NA	S	S
Security Alarm System <sup>*</sup> —audible/visual alarm system flashes headlamps and sounds horn when entry is attempted.	NA	NA	O <sup>1</sup>
Shift Lever—Leather	NA	NA	S
Speed Control	P	P	P
Steering Column—Tilt	S	S	S
Steering Wheel—Three-spoke, soft-feel	S	S	NA
Steering Wheel—Three-spoke, leather-wrapped	NA	NA	S
Sun Visor—Dual vanity mirrors (cover on driver's side)	S	S	S
Tonneau Cover	P	S	S
Windshield Wipers—Deluxe: with variable intermittent wipe	S	S	S



OPTIONAL EQUIPMENT PACKAGE CHARTS

LASER	POPULAR EQUIPMENT	DELUXE EQUIPMENT
Air Conditioning <sup>1</sup>	E	•
Cassette Radio with Eight Speakers in Six Locations	E	•
Cup Holder	•	•
Defroster—Rear window: electric <sup>2</sup>	•	•
Floor Mats—Front	•	•
Power-Assisted Steering	•	•
Speed Control	—	•
Tonneau Cover	•	•
Wheel Covers—Full 14-inch deluxe (set of four)	•	•

LASER RS	POPULAR EQUIPMENT	DELUXE EQUIPMENT	DELUXE EQUIPMENT WITH CD
Air Conditioning <sup>1</sup>	•	•	•
Compact Disc Player—Includes premium cassette radio with three-band graphic equalizer, high-power amplifier, and eight speakers in six locations	—	—	•
Cup Holder	•	•	•
Floor Mats—Front	•	•	•
Liftgate Wiper/Washer	•	•	•
Power Windows and Locks	—	•	•
Radio—Premium with cassette, nine-band graphic equalizer, high-power amplifier, and eight speakers in six locations	•	•	—
Speed Control	•	•	•

LASER RS TURBO	POPULAR EQUIPMENT	DELUXE EQUIPMENT	DELUXE EQUIPMENT WITH CD
Air Conditioning <sup>1</sup>	•	•	•
Compact Disc Player—Includes premium cassette radio with three-band graphic equalizer, high-power amplifier, and eight speakers in six locations	—	—	•
Cup Holder	•	•	•
Floor Mats—Front	•	•	•
Liftgate Wiper/Washer	•	•	•
Power Windows and Locks	—	•	•
Radio—Premium with cassette, nine-band graphic equalizer, high-power amplifier, and eight speakers in six locations	•	•	—
Speed Control	•	•	•

E — Available at extra cost.

<sup>1</sup> There are special engine cooling requirements for field-installed air conditioning. Failure to follow these requirements may invalidate warranty. See your dealer for details. <sup>2</sup> Required on all passenger vehicles registered in New York state, can be purchased separately.

Specifications are subject to change or improvement without notice. Certain models, packages and options are subject to specific restrictions, requirements or late availability. See your dealer for latest ordering information.

ENGINES

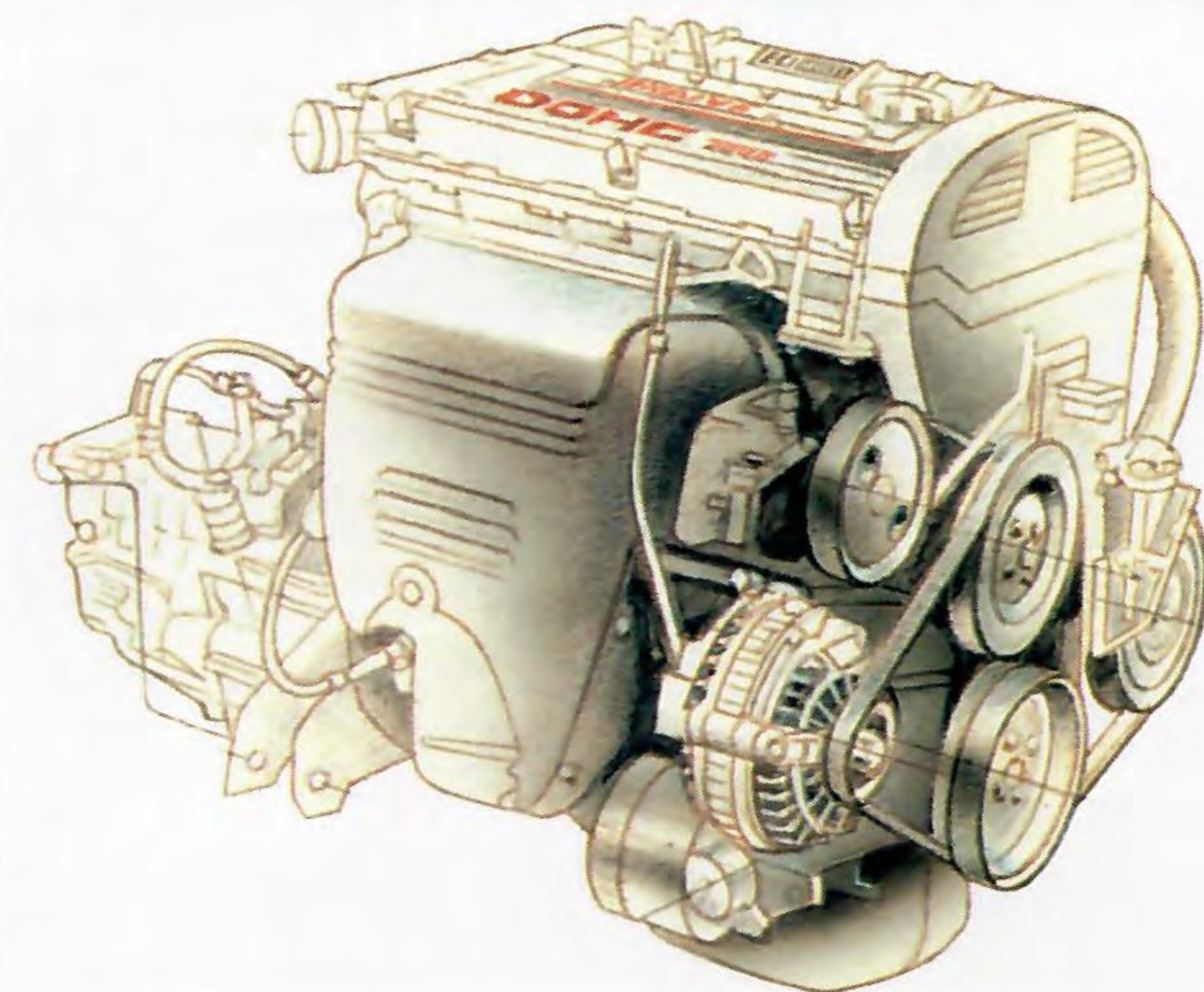

**2.0-LITER DOHC 16-VALVE MPI INTERCOOLED TURBOCHARGED ENGINE\*†**

Laser RS Turbo's 16-valve turbo engine features dual overhead cams (DOHC), multipoint electronic fuel injection (MPI), four-valves-per-cylinder head design, vibration-dampening dual balance shafts for smooth running, a turbocharger that helps to generate high torque and horsepower, and an intercooler to create cool, dense intake air. The most sophisticated power plant offered in a Plymouth.

**2.0-LITER DOHC 16-VALVE MPI ENGINE\***

Laser RS's 2.0-liter DOHC 16-valve MPI engine includes dual overhead cams (DOHC), four-valves-per-cylinder head design, multipoint electronic fuel injection (MPI), and dual balance shafts that dampen engine vibration. This engine produces substantial torque and horsepower performance with excellent fuel efficiency.

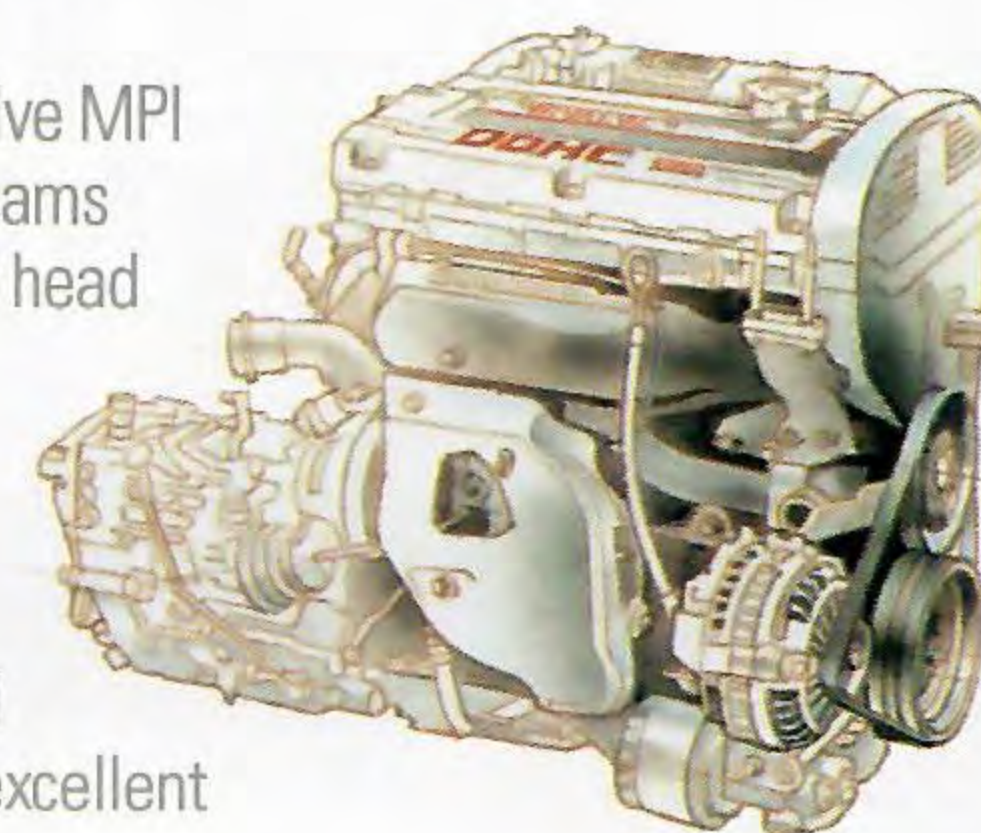

**1.8-LITER SOHC MPI ENGINE\***

Laser's 1.8-liter in-line four-cylinder engine includes electronic multipoint fuel injection (MPI) for optimal fuel metering and engine performance. Engineering includes a single overhead cam (SOHC), needle-bearing-mounted roller rocker arms with automatic valve lash adjustment and vibration-dampening dual balance shafts for smooth running, quiet operation, and reduced maintenance.

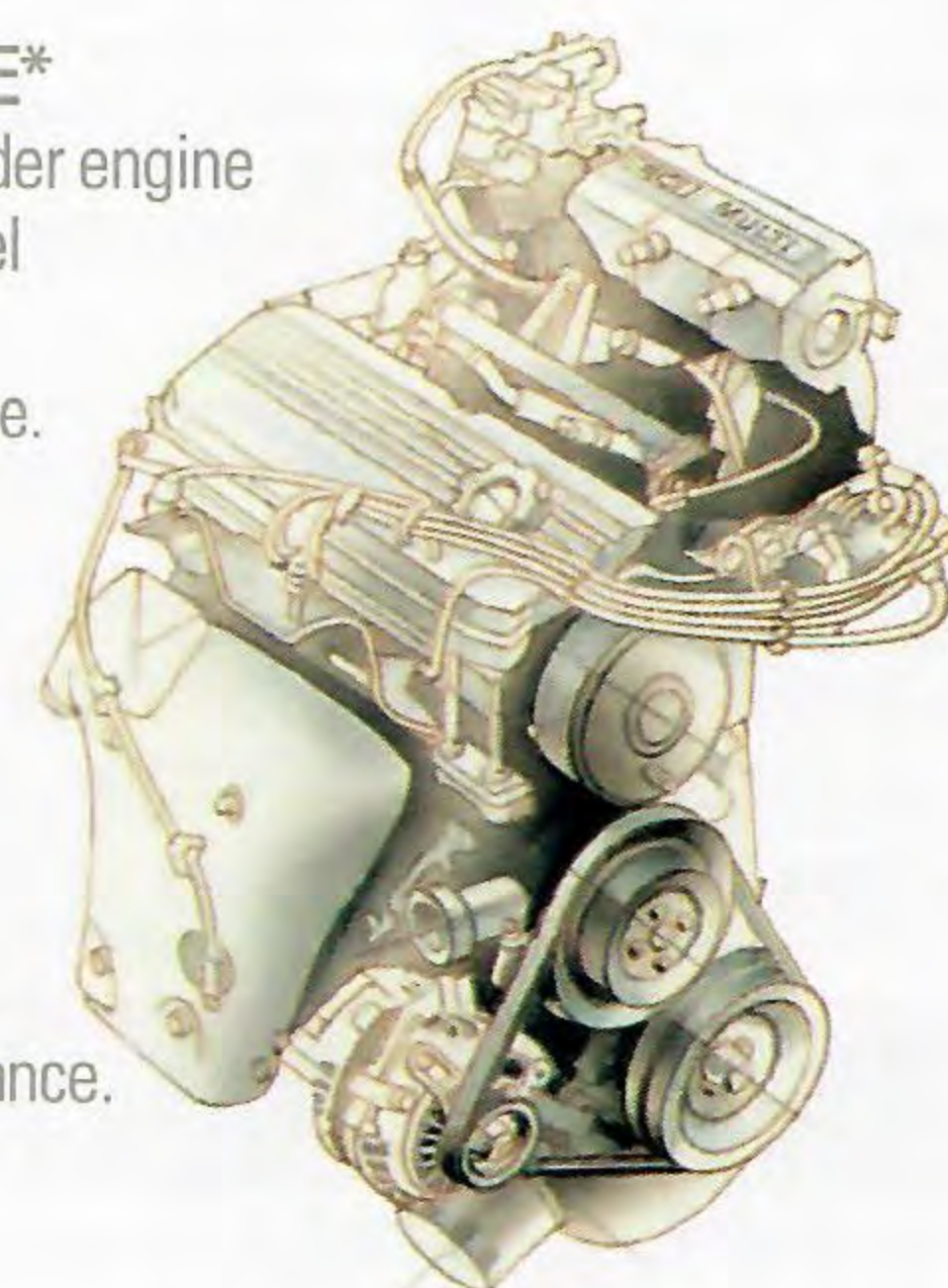

\*Built by Mitsubishi Motors Corporation.

†Premium unleaded fuel recommended. Turbocharged engine not recommended for trailer towing, and such use may damage engine and invalidate warranty. See your dealer for details.

MILEAGE\*

23 EPA est. city mpg, 32 EPA est. hwy. mpg

\*Mileage figures based on Laser base model with standard engine and 5-speed manual overdrive transaxle.

COLORS

EXTERIOR

INTERIOR

Medium Quartz Metallic	Dark Quartz
Light Spectrum Blue Metallic	Dark Quartz
Electric Blue Metallic	Dark Quartz
Bright White	Dark Quartz or Buckskin
Flash Red	Dark Quartz
Black	Dark Quartz or Buckskin
Warm Silver Metallic	Buckskin
Turquoise Metallic	Dark Quartz or Buckskin

Note: Clear Coat finish is standard on every 1991 Plymouth Laser.

TIRES

SIZE	TYPE (SET OF FOUR)	AVAILABILITY
P185/70R14	Steel-belted radial all-season tread, black sidewall	Standard Laser
P205/55HR16	Steel-belted radial all-weather performance handling, black sidewall	Standard Laser RS
P205/55VR16	Steel-belted radial all-weather performance handling, speed-rated black sidewall	Standard Laser RS Turbo
T125/70D15	Compact spare (one)	Standard all models

SCHEDULED MAINTENANCE

Here is a partial list of Plymouth Laser's standard scheduled maintenance items (Turbo engine may vary). The complete list can be found in the Owner's Manual.

Laser with standard 1.8-liter engine.

Engine oil and filter change ..... 7,500 miles or 12 months  
 Spark plug change ..... each 30,000 miles  
 Air filter replacement ..... each 30,000 miles  
 Engine coolant replacement ..... each 30,000 miles or 2 years  
 For severe service maintenance schedule, refer to Owner's Manual.



Quality Worth Backing

All Chrysler Motors domestically built automobiles and light trucks now benefit from the 7/70 Power Train Limited Warranty. Upon expiration of the basic 12-month or 12,000-mile Basic Limited Warranty, coverage is extended on power train components to seven years or 70,000 miles.\* This represents one of the most comprehensive original limited warranties available on cars and trucks built and sold in the United States, and points out Chrysler Motors' pride in building and backing its products the right way.

In addition to the 7/70 Power Train Limited Warranty described above, all domestically built Chrysler Motors automobiles offer the 7/100 Anticorrosion Limited Warranty. Your dealer will repair or replace at no charge outer body sheet metal panels found to have developed perforation (rust-through) in normal use up to seven years or 100,000 miles. See your dealer for a copy of the limited warranties.

\*A deductible applies

**Optional Service Contract Coverage** Chrysler Service Contracts provide you with additional peace-of-mind protection for your new vehicle. Chrysler Motors offers a variety of plans to meet your needs. Plan coverage begins after your vehicle's basic warranty expires. A deductible applies. Allowances for car rental and towing are also included. See your dealer for details.



MOPAR parts are engineered by Chrysler Motors for use in your new Plymouth Laser. When replacement is necessary, be sure to specify MOPAR parts.

Used by professional automotive technicians worldwide.

**Chrysler Cellular Systems** OKI® Telecom manufactures, services and is the warrantor of the Visophone, Mobile phone and Portable phone products that are available on selected Chrysler Motors vehicles. See your dealer for a copy of the limited warranties. Restrictions apply.

**Consider Leasing** More consumers are considering leasing as an alternative to buying. Leasing a new Plymouth Laser usually involves a small security deposit and a first month's lease payment. Monthly payments frequently are less than financing a new car purchase. Ask your dealer for details.

**Chrysler Credit Making the best even more affordable.** Chrysler Credit offers a variety of finance programs that will help make your new Plymouth Laser even more affordable. These special finance and leasing programs are designed to meet the needs of today's automotive buyer. They include Gold Key Lease, America's Choice Payment Plan, College Graduate Plans, Retail Financing, and more. Ask your salesperson for details.

**Chrysler Purchase Assistance Program for the Physically Challenged** Cash reimbursements of up to \$500 are available for qualified adaptive driving devices on 1991 Chrysler Motors cars and trucks. For further information, contact your dealer or the PHYSICALLY CHALLENGED RESOURCE CENTER AT 1-800-255-9877.

All product illustrations and specifications are based upon current information at the time of publication approval. Although descriptions are believed correct, complete accuracy cannot be guaranteed. Chrysler Motors reserves the right to make changes from time to time, without notice or obligation, in prices, specifications, colors and materials, and to change or discontinue models. See your dealer for the latest information.

Plymouth and MOPAR are registered trademarks, and Laser is a trademark of Chrysler Corporation.

**Buckle up for safety.**





I'm proud of the quality and honest value we build into our products. But a lot of Americans aren't aware of it and that's got to change. Our 1991 Plymouths have real advantages over their import and domestic competition. Take Plymouth Laser. For safety, you'll find available antilock brakes, a motorized passive restraint system with active lap belts in front, and rear lap/shoulder belts. That saves lives. Laser is also backed by seven years or 70,000 miles of power train protection, and seven years or 100,000 miles against outer body rust-through—one of the best limited warranties of any vehicle made. All of these advantages add up to a vehicle that we believe no other car company in the world can beat. Take a good look at Plymouth Laser versus the competition. For style, value, standard features, and advanced engineering, the other guys simply don't measure up. Advantage: Plymouth. But best of all, Advantage: customer.



VOYAGER • ACCLAIM • SUNDANCE • LASER • COLT • VISTA