

1973 Plymouth **SATELLITE**

Satellite Sebring-Plus/Satellite Sebring/Satellite Custom Sedan/
Satellite Sedan/Satellite Coupe/Road Runner





Background/ Foreground: Satellite Sebring-Plus 2-Door Hardtop

Satellite Sebring-Plus

Here is the car that is built to be seen . . . but not heard. The Satellite Sebring-Plus. The Plus stands for things like a "Super-Quiet" sound package with 38 additional square feet of sound-deadening material plus Torsion-Quiet Ride. A restyled exterior that's as contemporary as today. A standard 318 V-8 that runs on regular, low-lead gas. And special Sebring-Plus exterior ornamentation and a plush interior.

It's a Plus that adds up to extra value for you.
Extra care in engineering . . . it makes a difference.



Satellite Sebring

Like the Satellite Sebring-Plus, the Satellite Sebring has been restyled in a fresh, contemporary way. The front end features dual headlamps and an extra-protection bumper system capable of withstanding 5 mph head-on impact forces. The rear bumpers can withstand a 2½ mph impact. Torsion-Quiet Ride and a 115-inch wheelbase help make the Satellite Sebring a quiet, smooth-riding car that's sized right for the city . . . handles right on the freeway. Extra care in engineering . . . it makes a difference.

Satellite Sebring 2-Door Hardtop



Satellite Sedans

Here are two ways to get family-size room in a mid-size package. Satellite Custom and Satellite Sedan. They are unique among intermediates because Chrysler Corporation believes sedans require a different kind of design and styling than hardtops. Result? Sedans with a different look on the outside . . . more room on the inside. Even with the longer 117-inch wheelbase, a Satellite sedan remains easy to park and handle.

Extra care in engineering . . . it makes a difference.

Background: Satellite 4-Door Sedan Foreground: Satellite Custom 4-Door Sedan



Satellite Coupe

Even our lowest priced Satellite model gives you things you can't get in competitive intermediates. Torsion-Quiet Ride for smooth handling, quiet driving. An Electronic Ignition System to cut down on emissions and tune-up costs. Torsion-bar suspension for firm, sure control behind the wheel. And unibody construction for a solid body structure.



Road Runner

Young America's favorite bird—the Road Runner—has lost none of its sporty appeal in '73.

Basic standard equipment includes: A 318 cu. in. V-8 with dual exhaust and bright chrome exhaust tips. Floor-mounted three-speed, all-synchromesh, manual transmission. Front and rear sway bars. Front disc brakes. F70 x 14 raised white letter tires mounted on rallye wheels. A performance hood. And special Road Runner dress-up stripe and identification. Extra care in engineering . . . it makes a difference.

Background / Foreground: Road Runner Coupe

Satellite Interiors

We've spent a lot of time and effort making the inside of our Satellites as well styled as the outside. They are comfortable—with room enough for six. But sitting is believing . . . so try one soon.

Shown below, standard Satellite Sebring-Plus

(optional on Road Runner) all-vinyl bucket seats with integral head restraints. Available in blue, green, parchment, black, white, and gold. Shown at the right is the standard Satellite Sebring and Satellite Custom cloth-and-vinyl bench seat. Available in blue, green, black, and gold.

Rich, simulated wood-grain inserts are used to

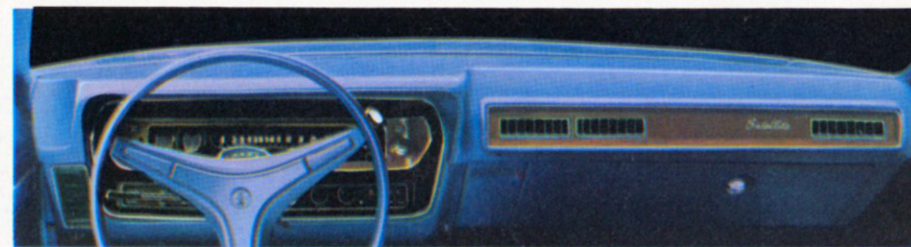

highlight the Satellite Sebring instrument panel. The door trim panels also feature a simulated wood appliqué. Complete gauges, rather than warning lights, in the panel keep you informed of what's happening. All standard.



Extra care in engineering . . . it makes a difference.

A. Optional at no extra cost is the Satellite Sebring-Plus cloth-and-vinyl split-back bench seat with fold-down center armrest. Available in blue, green, black, and gold.

B. Standard Satellite Sedan all-vinyl bench seat. Available in blue, green, and black.

C. Optional Satellite Sebring all-vinyl bench seat. Available in blue, green, parchment, black, and

gold. (This seat is also available on Road Runners with the optional Decor Package.)

D. Optional Satellite Custom all-vinyl bench seat. Available in blue, green, parchment, black, and gold.

E. Standard Satellite Coupe and Road Runner all-vinyl bench seat. Available in blue, green, and black.



Satellite Interiors

A. Optional (at no extra cost) Satellite Sebring-Plus cloth-and-vinyl bench seat.

B. Standard Satellite Sedan all-vinyl bench seat.

C. Optional Satellite Sebring and Road Runner all-vinyl bench seat.

D. Optional Satellite Custom all-vinyl bench seat.

E. Standard Satellite Coupe and Road Runner all-vinyl bench seat.

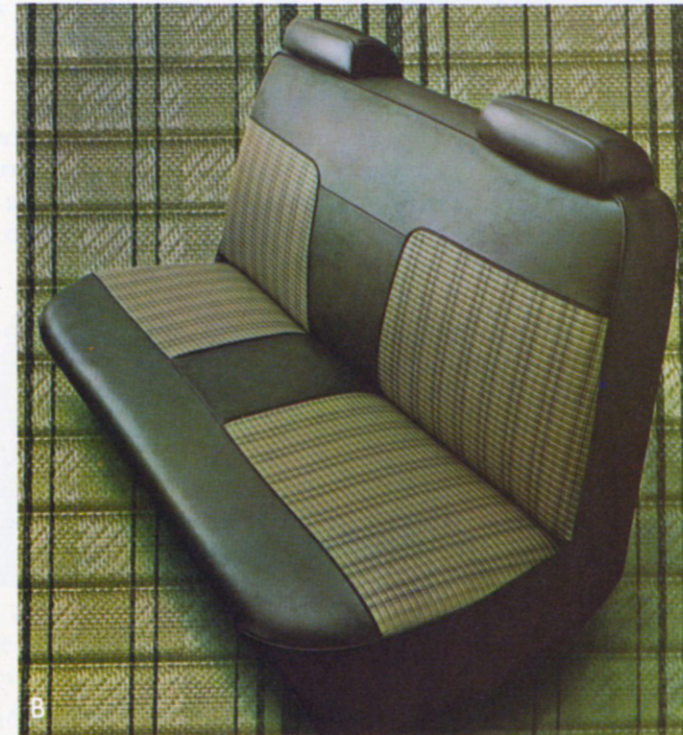

Extra care in engineering . . . it makes a difference.

What Makes A Satellite A Satellite.

The best way to describe all of our 1973 Satellites is to say they are built to be seen . . . not heard.

The reason for our new quiet is Chrysler's famed

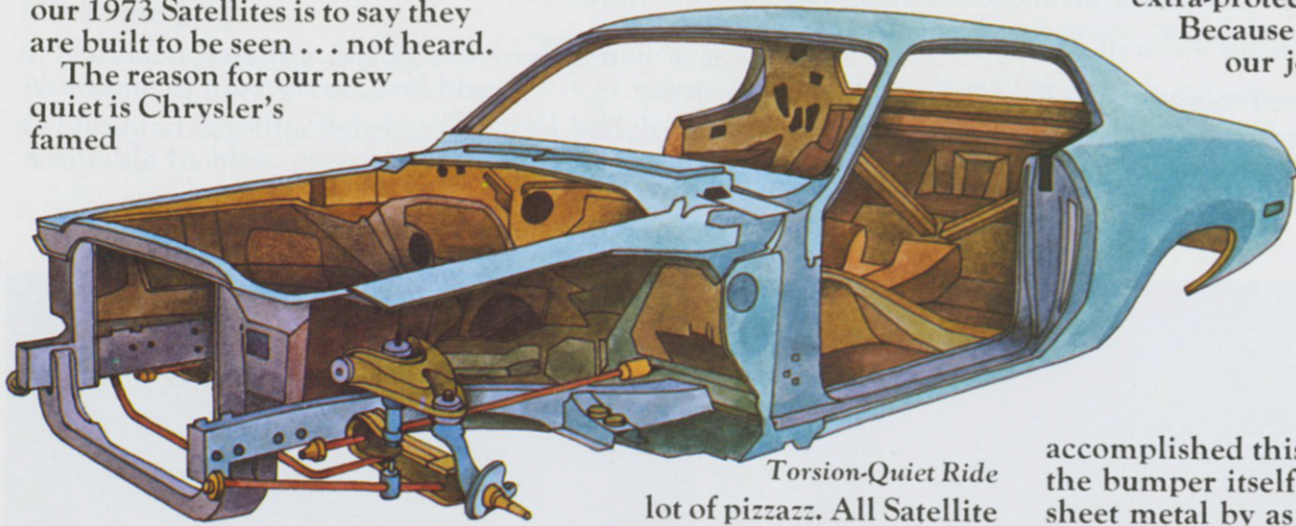

Torsion-Quiet Ride

Torsion-Quiet Ride. A unique combination of front torsion-bar suspension, unibody construction and sound isolators. The result is a quiet, controlled riding experience.

Every new Satellite has Torsion-Quiet Ride. And the Sebring-Plus has even more sound-reducing features. It's one of our "Super-Quiet" cars for '73. Included are sound deadeners and silencers in the floor, luggage compartment, door trim panels, steering column, exhaust system, rear wheel-housings and rear shelf panel.

These additions make this year's Satellite Sebring-Plus the quietest intermediate-size car ever built by Plymouth.

The "seen" part is obvious. It's a family car with a

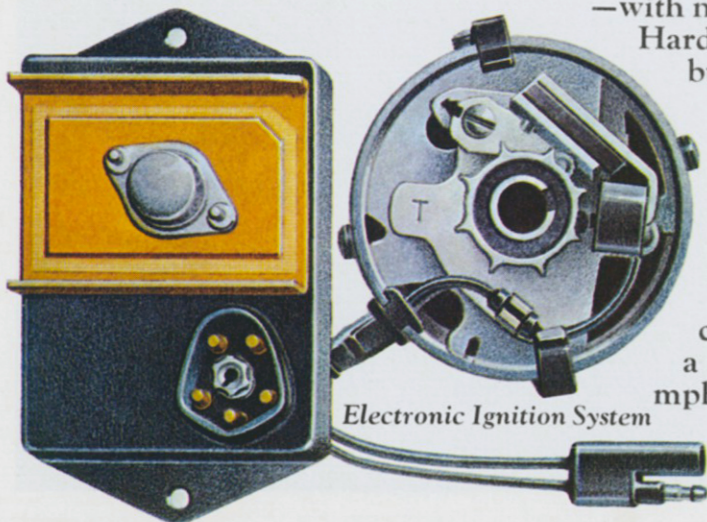

Electronic Ignition System

lot of pizzazz. All Satellite 2-door models have been restyled in a fresh, tasteful look that's unique among intermediate cars.

If you take

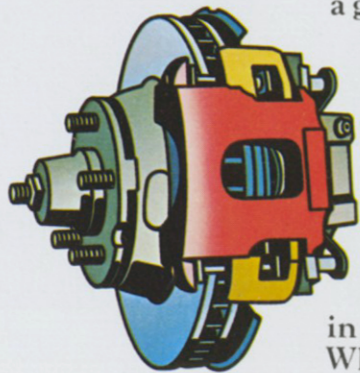

Front Disc Brakes

a good look at the Satellite sedans and hardtops, you'll see that they are distinctly different in style.

When we set out to build the kind of car

America wants, we felt that two different body types deserved two different kinds of design and styling.

The result is two different looks for the sedan and hardtops—with no compromising.

Hardtop and sedan buyers can each have a car just right for their particular needs.

Our engineers have designed an extra-protection bumper system capable of impacting a fixed barrier at 5 mph in the front and 2½ mph in the rear without significant damage to any

portion of the car. Why do we call these bumpers "extra-protection?"

Because we've done our job in meeting or exceeding the federal government's new damage standards for low-speed accidents.

Some of the ways we accomplished this are by setting the bumper itself out from the sheet metal by as much as two inches to provide impact protection, and by locating a full-width reinforcement behind the bumper surface to provide increased beam strength during impact. There's also a bumper support structure using heavy-gauge steel with deep sections. In addition to their impact capabilities, the elastomeric bumper guards help keep your 1973 Satellite from slipping over or under another car's bumper during a low-speed impact.

We've also built in protection for your car with an ignition key warning buzzer and an anti-theft steering column lock. In addition, all Satellites now have a new deck lid lock design that offers substantially increased resistance to illegal entry.

You also get an Electronic Ignition System standard. Compared to a conventional ignition system, Satellite's system is a hands-down winner. For example, there are no points or condenser. So you may never have to worry about periodic ignition tune-ups. Your original engine timing should be good for 50,000 miles or more.

Excluding routine spark plug service, the system is virtually maintenance free.

You also get a consistently higher voltage—by as much as 35%—for more dependable starts even in cold and damp weather. Electronic ignition helps eliminate many of the major causes of an engine misfiring, thus reducing engine emissions caused by a weak spark.

Emissions are further reduced by an



Sun Roof

electric assist choke, which consists of a heater element in the automatic choke well to shorten the



Trailer-Towing Package

period of choke operation.

On Satellite, Satellite Custom and Satellite Sebring models you have a choice of either a 225 Six or a 318 V-8.

On Satellite Sebring-Plus and Road Runner models the 318 V-8 is the standard engine.

All Satellite engines are capable of running on regular, low-lead, or no-lead gas.

Optional engines are the 400 cu. in. V-8 (2- and 4-barrel

versions) for all models plus the 340 and 440 V-8 for the Road Runner.

Satellite's standard transmission is a 3-speed manual that's been improved to reduce shift effort. Front disc brakes are standard, too. If you want, add an optional power booster to them.

Another popular option for Satellite is the legendary Torque Flite transmission.

For 1973, we've improved our TorqueFlite with a new hydrodynamic front pump seal. There's also a new transmission fluid filter that provides a 50% increase in filtering area to lengthen the life of both fluid and transmission.

Other options include air conditioning, vinyl roof, new AM/FM monaural or AM/FM stereo radio, and a sun roof. This modestly priced, factory-installed, sliding metal sun roof is manually operated. It's available on all



Extra-Protection Bumper System

2-door models—with or without a vinyl roof.

Or you may wish to have our optional trailer-towing package. With it, your Satellite can tow up to 6,000 pounds of boat, camper, or whatever you wish. For full details on trailer-towing, ask your dealer for our 1973 Trailer-Towing Guide.

We're committed to building the kind of car America wants. This means your '73 Satellite has a lot of little touches like all-nylon cut-pile carpeting for improved wear. Newly designed windshield wipers to minimize smearing and streaking. Easy operating door handles. A new combination heater/air conditioning control. And all instrument panel controls are fully illuminated.

We are also committed to

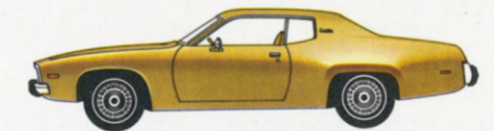

Satellite Design Concept

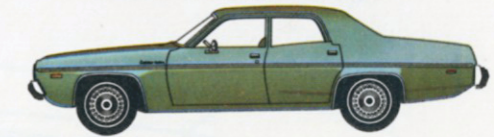

protecting the environment. Our Cleaner Air System is a highly integrated emission control system that has evolved through engineering, to effectively reduce the level of automotive emissions. Emission controls for our '73 cars, as compared to cars having no emission controls, are as follows: Total hydrocarbons reduced by about 85%, carbon monoxide reduced by about 70%, and oxides of nitrogen by about 50%.

We've done all of these things because we feel this is the kind of car you want.



Cleaner Air System

A family car that's functional—with style and flair.

A mid-size car with interior room big enough for six adults. A smooth-handling car with new interior quiet.

The 1973 Satellite coming through for you.

Extra care in engineering . . . it makes a difference.

Extra care in engineering . . . it makes a difference.

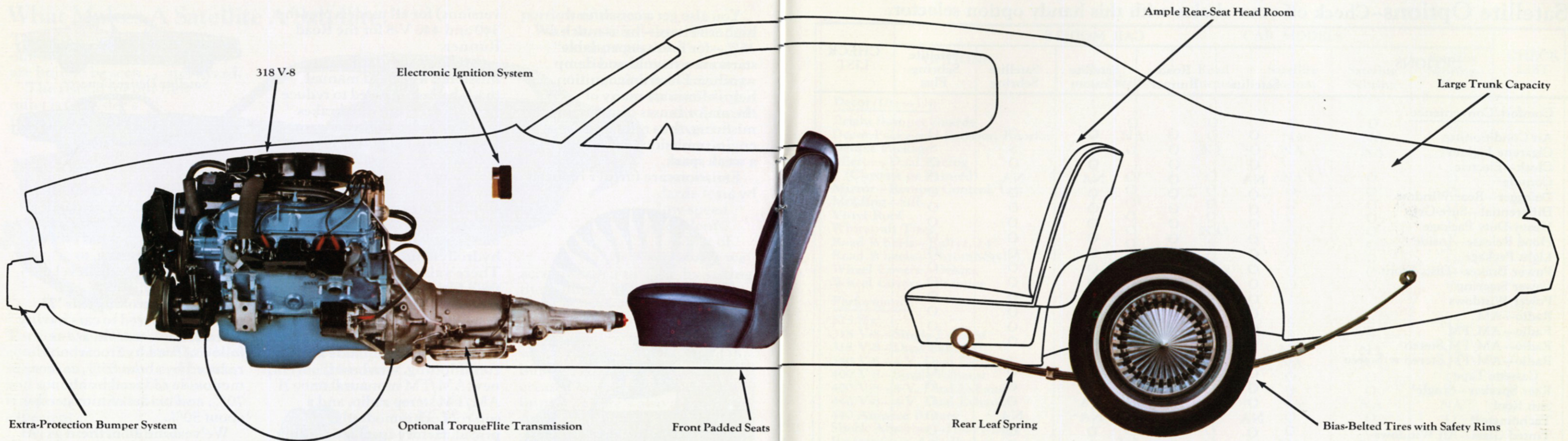

Extra Care In Engineering . . . It Makes A Difference.

We've done a lot to make this year's Satellite one of the quietest mid-size cars on the road. To

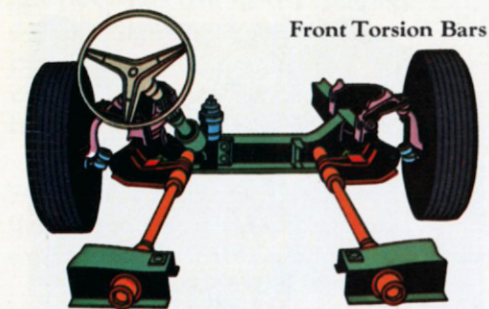

achieve this, we put in an isolated suspension system and other sound-deadening components. The result is Chrysler's famed Torsion-Quiet Ride.

For 1973, both the front and rear suspensions on all our Satellite models are isolated to provide a quiet, smooth ride.

The front suspension, a new design, utilizes an isolated cross member separated from the body by six rubber isolators.

Front torsion bars twist to soften road shock and help to

smooth out bumpy roads.

Rubber surrounds the rear-leaf spring clamps to reduce vibration, road harshness and noise.

In addition, rubber bushings, spool-type engine mounts and a double coupling between the steering column and the steering gear cut down further on noise and vibration.

We've managed to make your 1973 Satellite quieter by the effective use of acoustical material. We've also added a larger tail pipe and

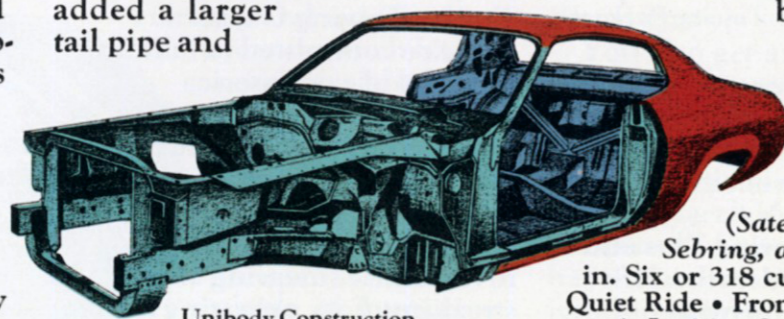

a retuned muffler to all 318 V-8's to reduce engine noise.

You can't unbolt a Satellite body from its frame, because

every Satellite is built the Unibody way. Our engineers believe that the over 4,000 welds we use make the car body tough and strong and help eliminate rattles.

To help stop rust before it starts, every Satellite body goes through our 7-step dip-and-spray process. Then our new acrylic dispersion enamel is used for the body exterior coat to make sure your car stays bright and shiny for a long time to come.

The 1973 Satellite is built to be seen . . . not heard.

Satellite Standard Features

(Satellite Coupe, Sedan, Sebring, and Custom) 225 cu. in. Six or 318 cu. in. V-8 • Torsion-Quiet Ride • Front disc brakes • Electronic Ignition System • 3-speed fully synchronized manual transmission • Color-keyed rubber floor covering (Satellite Coupe, and Sedan) Color-keyed carpet (Satellite Sebring and Custom) • Front armrest with bright

bases (Satellite Custom only) • Rear-seat armrest with bright bases and ashtrays (Satellite Custom only) • Cigarette lighter (except Satellite Coupe) • Glove box lock • Dome light • Transistorized voltage regulator • Hub caps • Cleaner Air System • Soft coat hooks • Heater and defroster • Dual horns (except Satellite Coupe) • Bias-belted tires.

Satellite Sebring-Plus Standard Features

(Satellite standard features plus these additions and substitutions.) 318 cu. in. V-8 • "Super-Quiet" sound package • Bucket seats • Rallye cluster • Premium door trim panel with simulated wood-grain appliqué • Steering wheel with simulated wood-grain insert • Deluxe wheel covers • Belt molding • Body side tape stripes • Special Sebring-Plus trim and ornamentation.

Road Runner Standard Features

(Satellite Coupe standard features plus these additions and substitutions.) 318 cu. in. dual-exhaust V-8 • Floor-mounted three-speed manual fully synchronized transmission • Heavy-duty springs • Front and rear sway bars • Performance hood • Low-restriction dual exhaust system with chrome exhaust tips • Argent-painted 14" Rallye wheels with chrome hubs • 8 1/4" axle, 3.21 ratio • "Beep-Beep"

horn • Rallye instrument cluster • Body side and roof "strobe" tape stripe • Road Runner trim and ornamentation.

Standard Safety Features

Extra-protection bumper system capable of withstanding head-on barrier impact forces of 5 mph, front, and 2 1/2 mph, rear • Less flammable interior material • Large rear reflectors and lights • Fuel-tank impact protection • Turn signals with lane-change feature • Locking steering column • Energy-absorbing instrument panel, front seat-back and armrests • Seat belts, all seating positions • 3-point hook-up arrangement on seat belts with front shoulder belts • Inside door locks • Keyless door locking • Cushioned sun

visors with center supports • Dual braking system with warning lights • Side marker lights and reflectors • Hazard warning light system • Back-up lights • 2-speed electric windshield wipers • Electric windshield washers • Head restraints, 2 front • Locking latch on all folding front seat-backs • Dual action safety hood latches • Parking lights that illuminate with headlights • Energy-absorbing steering column • Safety door latches and hinges • Thick-laminate safety glass windshield • Glove box door latch • Safety skid-type windshield header • Roll-over-protection roof structure • Recessed door handles • Inside rearview mirror and left outside rearview mirror • Safety-Rim wheels.

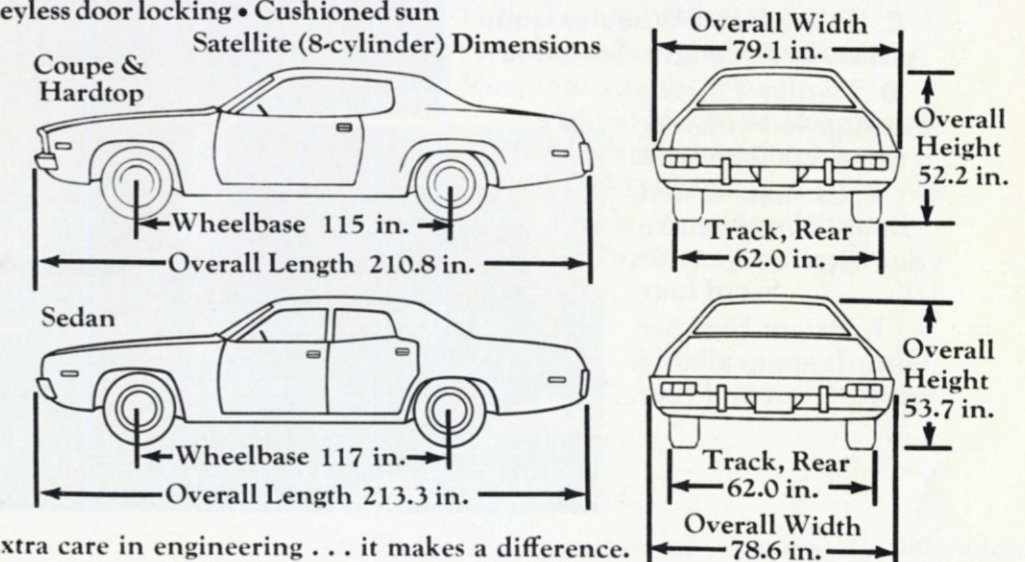

Extra care in engineering . . . it makes a difference.

Satellite Options—Check off your choice with this handy option selector.

OPTIONS	CAR MODELS					CHECK LIST
	Satellite	Road Runner	Satellite Custom	Satellite Sebring	Satellite Sebring-Plus	
Comfort/Convenience						
Air Conditioning	O	O	O	O	O	
Cigarette Lighter	O ¹	O	S	S	S	
Clock—Electric	O	O	O	O	O	
Console ²	NA	O	NA	NA	O	
Defogger—Rear Window	O	O	O	O	O	
Differential—Sure-Grip	O	O	O	O	O	
Heavy-Duty Package	O	O	O	O	O	
Hood Release—Inside	O	O	O	O	O	
Light Package	O	O	O	O	O	
Power Brakes—Disc, Front	O	O	O	O	O	
Power Steering	O	O	O	O	O	
Power Windows	O	O	O	O	O	
Radio—AM	O	O	O	O	O	
Radio—AM/FM	O	O	O	O	O	
Radio—AM/FM Stereo	O	O	O	O	O	
Radio—AM/FM Stereo w/Stereo Cassette Tape	O	O	O	O	O	
Rear Speaker—Single ³	O	O	O	O	O	
Sun Roof	O ¹	O	NA	O	O	
Tachometer ⁴	NA	O	NA	NA	O	
Tinted Glass—All Windows	O	O	O	O	O	
Tinted Glass—Windshield Only	O	O	O	O	O	
Trailer-Towing Package	O	O	O	O	O	
Trailer-Wiring Package	O	O	O	O	O	
“Tuff” Steering Wheel	O	O	O	O	O	
Undercoating & Hood Pad	O	O	O	O	O	
Ventilation—Strato	O	O	O	O	O	
Windshield Wipers—3-Speed	O	O	O	O	O	

O—Optional S—Standard NA—Not Available ¹Coupe only ²Bucket seats only. NA with ³3-speed manual transmission
⁸Chrome exhaust tips on 2-door models only ⁹Available with 400 V-8 (4-V) only ¹⁰NA on 440 V-8 (4-V)

OPTIONS	CAR MODELS					CHECK LIST
	Satellite	Road Runner	Satellite Custom	Satellite Sebring	Satellite Sebring-Plus	
Decor/Dress-Up						
Bright Bumper Guards	O	O	O	O	O	
Decor Packages—Exterior, Interior	NA	O	NA	NA	NA	
Deluxe Package	O	NA	NA	NA	NA	
Mirror—Dual Racing (Chrome or Painted)	O ¹	O	NA	O	O	
Mirror—Remote Control, Left	O	O	O	O	O	
Molding—Sill	O ⁵	O	O	O	O	
Vinyl Roof	O	O	O	O	O	
Whitewall Tires	O	NA ⁶	O	O	O	
Road Wheels—Rallye, 14"	O	S	O	O	O	
Road Wheels—Chrome-Style	O	O	O	O	O	
Wheel Covers—Deluxe	O	NA	O	O	S	
Wheel Covers—Premier	O	NA	O	O	O	
Performance						
225 Six	S	NA	S	S	NA	
318 V-8—Single Exhaust	S	NA	S	S	S	
318 V-8—Dual Exhaust ⁷	NA	S	NA	NA	NA	
340 V-8—4-V, Dual Exhaust ⁷	NA	O	NA	NA	NA	
400 V-8—Single Exhaust	O	NA	O	O	O	
400 V-8—4-V, Dual Exhaust ⁸	O	O	O	O	O	
440 V-8—4-V, Dual Exhaust ⁷	NA	O	NA	NA	NA	
440 Ampere Battery	O	O	O	O	O	
Shock Absorber—Heavy-Duty	O	O	O	O	O	
Performance Axle Package	NA	O	NA	NA	NA	
Transmission—3-Speed Manual (floor-mounted)	NA	S	NA	NA	NA	
Transmission—3-Speed Manual (column-mounted)	S	NA	S	S	S	
Transmission—4-Speed Manual (318 dual exhaust, 340, and 400—4-V)	O ⁹	O ¹⁰	O ⁹	O ⁹	O ⁹	
Transmission—TorqueFlite Automatic	O	O	O	O	O	

³Standard with stereo ⁴NA with clock ⁵Standard on sedan ⁶Raised white letter tires standard ⁷With chrome exhaust tips

A. Inside Hood Release is extra protection for your engine compartment.

B. Sun Roof lets you let the sunshine in via a manually operated, metal panel. Available with or without a vinyl roof.

C. Rallye Road Wheels are an enthusiast's delight. Set of four.

D. Trailer-Towing Package lets you tow up to 6,000 pounds.

E. Chrome-Styled Road Wheels make your Satellite sportier. Set of four.

F. Bright Bumper Guards are available for the front and rear.

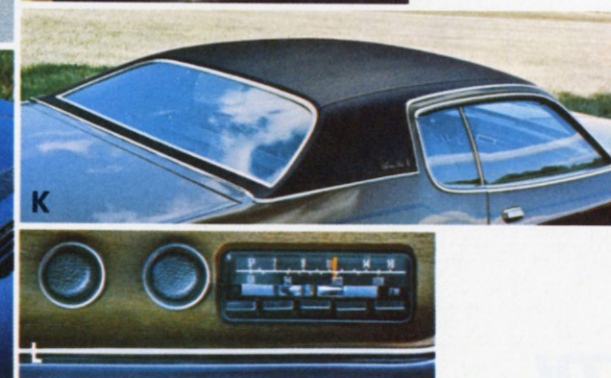
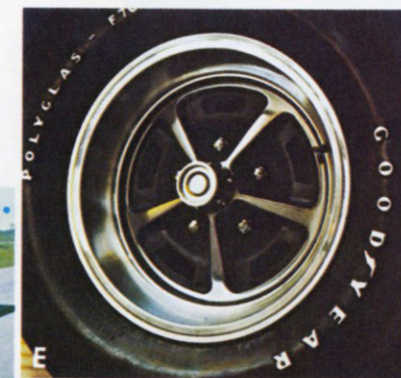
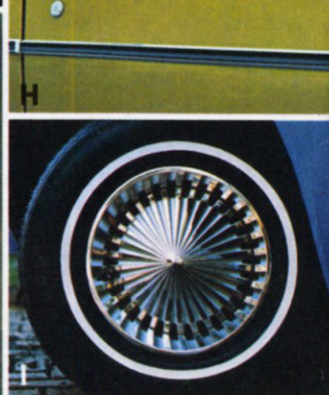
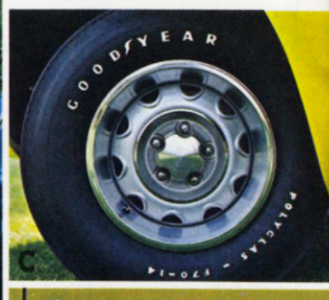
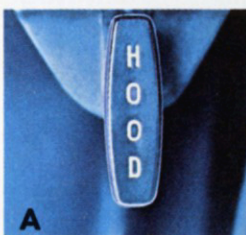

G. Stereo Tape Cassette lets you play your own choice of music.

H. Body Side Vinyl Moldings help protect the sides of your car from accidental dings.

I. Premier Wheel Covers add more glamour to your car. Set of four. Not available on Road Runner.

J. Hood Tape Treatment lets you dress up your Road Runner even more.

K. Vinyl Roof is available in five colors: black, white, green, parchment, and gold.

L. AM/FM Radio gives you a wide selection of radio stations.

1973 Plymouth Satellite Exterior Colors



Silver Frost Metallic



Blue Sky



Basin Street Blue



True Blue Metallic



Rallye Red



Mist Green



Amber Sherwood Metallic



Forest Green Metallic



Autumn Bronze Metallic

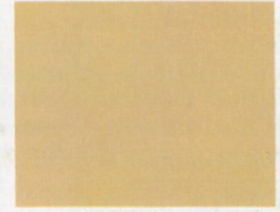

Sahara Beige

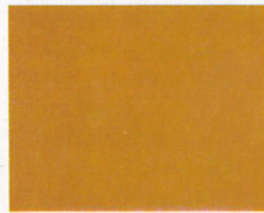

Mojave Tan Metallic



Lemon Twist*

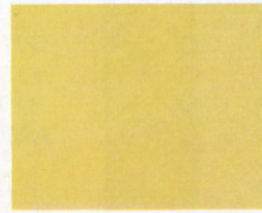

Honey Gold



Golden Haze Metallic



Tahitian Gold Metallic



Spinnaker White



Formal Black

*Optional at extra cost.

All product illustrations and specifications are based on authorized information. Although descriptions are believed correct at publication approval, accuracy cannot be guaranteed. Some of the equipment shown on product illustrations is optional, at extra cost. Chrysler Motors Corporation reserves the right to make changes from time to time, without notice or obligation, in prices, specifications, colors and materials, and to change or discontinue models.

Keep your Plymouth coming through in top condition. Service it with men who know it best. See your Plymouth Dealer.



KEEP YOUR
CAR
"FACTORY NEW"
WITH GENUINE
MOPAR PARTS

Plymouth

