

1 9 9 3

PLYMOUTH

DUSTER

SUNDANCE



PATTERSON - CHRYSLER - PLYMOUTH
JEEP - EAGLE
1965 N. Ellsworth Ave.
Salem, Ohio 44460
216-337-3475

SPORTY,
AGGRESSIVE
AND
VALUE-PACKED



Some of the equipment shown or described throughout this catalog is available at extra cost.

About this catalog. Since the time of printing, some of the information you'll find in this catalog may have been updated. Ask your dealer for details.

Duster

SUNDANCE: AFFORDABLE FUN DUSTER: EXPRESSIVE PERFORMANCE

The 1993 Sundance and Duster, with more than 40 standard features including a driver-side air bag, are among the best-equipped family cars in the small-car class. Along with its welcome affordability, Sundance is sporty, fun to drive, durable, and dependable. There are other things to like about Sundance... contemporary aerostyling, front-

antilock disc brakes — is now available. Other safety features such as child-protection rear door locks and side door beams are standard (see details on this page and on page 15). Duster offers all the qualities of Sundance, plus a distinctively sporty personality with standard V6 power, and more. Individual tastes are further accommodated



Duster



Sundance

wheel-drive engineering, agile performance, comfortable seating for five, and liftback versatility. But safety doesn't take a back seat to fun and practicality in this car. A major new safety advantage — four-wheel

with the choice of two-door or four-door body styles, making Duster and Sundance fully capable of meeting the needs of the single commuter or the young family. Clearly, Duster and Sundance maintain Plymouth's tradition of delivering a lot of car for the money. Add to this the strong Owner's Choice Protection Plan (see page 19), and you've made an even wiser choice.

Advantage: Sundance.

SAFETY FIRST

■ **Driver-Side Air Bag**
Provides added safety for the driver when used with a lap-and-shoulder restraint. Standard.

■ **Three-Point Unibelt Restraint System**
Standard lap and shoulder belts help protect outboard front- and rear-seat passengers.

■ **Four-Wheel Antilock Disc Brake System**
Contributes to braking stability on slippery roads, helps driver maintain vehicle control during hard braking. Optional.

■ **Child-Protection Rear Door Locks**
Help keep kids secure while riding in the rear seat. Child-protection locks are standard on four-door Duster and Sundance models.

■ **Energy-Absorbing Bumpers**
Standard steel front and rear bumper reinforcements offer protection that meets federal impact safety standards.

SPORTY AND VALUE-PACKED



Duster



Duster's sporty styling features a monochromatic look, power dome hood, 15-inch Triad wheel covers, and "Duster" deck lid and bodyside decals. Handling is quick and precise, thanks to an advanced sport suspension, speed-rated steel-belted radial tires, and power-assisted 16-to-1 ratio rack-and-pinion steering.



The color-keyed standard rear spoiler is another distinguishing mark of Duster's sporty design.

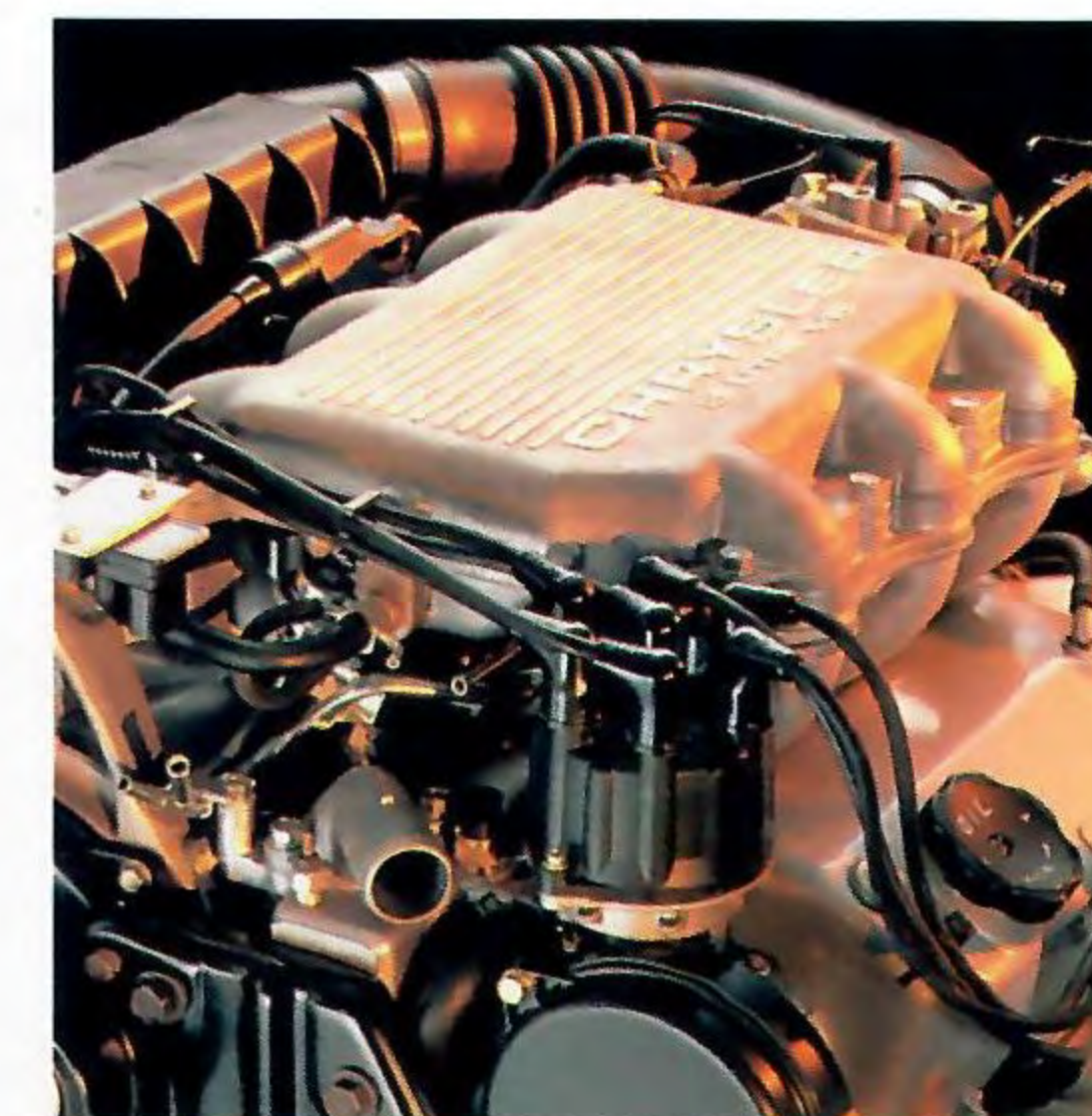

A smooth, responsive standard 3.0-liter OHC (overhead cam) V6* MPI (multipoint fuel-injected) engine gives Duster its exhilarating performance.

*See page 16 for details.



Speed- and impact-sensitive retractors cause the seat belts to operate instantly during severe deceleration or in a collision.



Simulated air bag deployment shown.

The standard driver-side air bag has proved its outstanding reliability in extensive crash testing and in service.

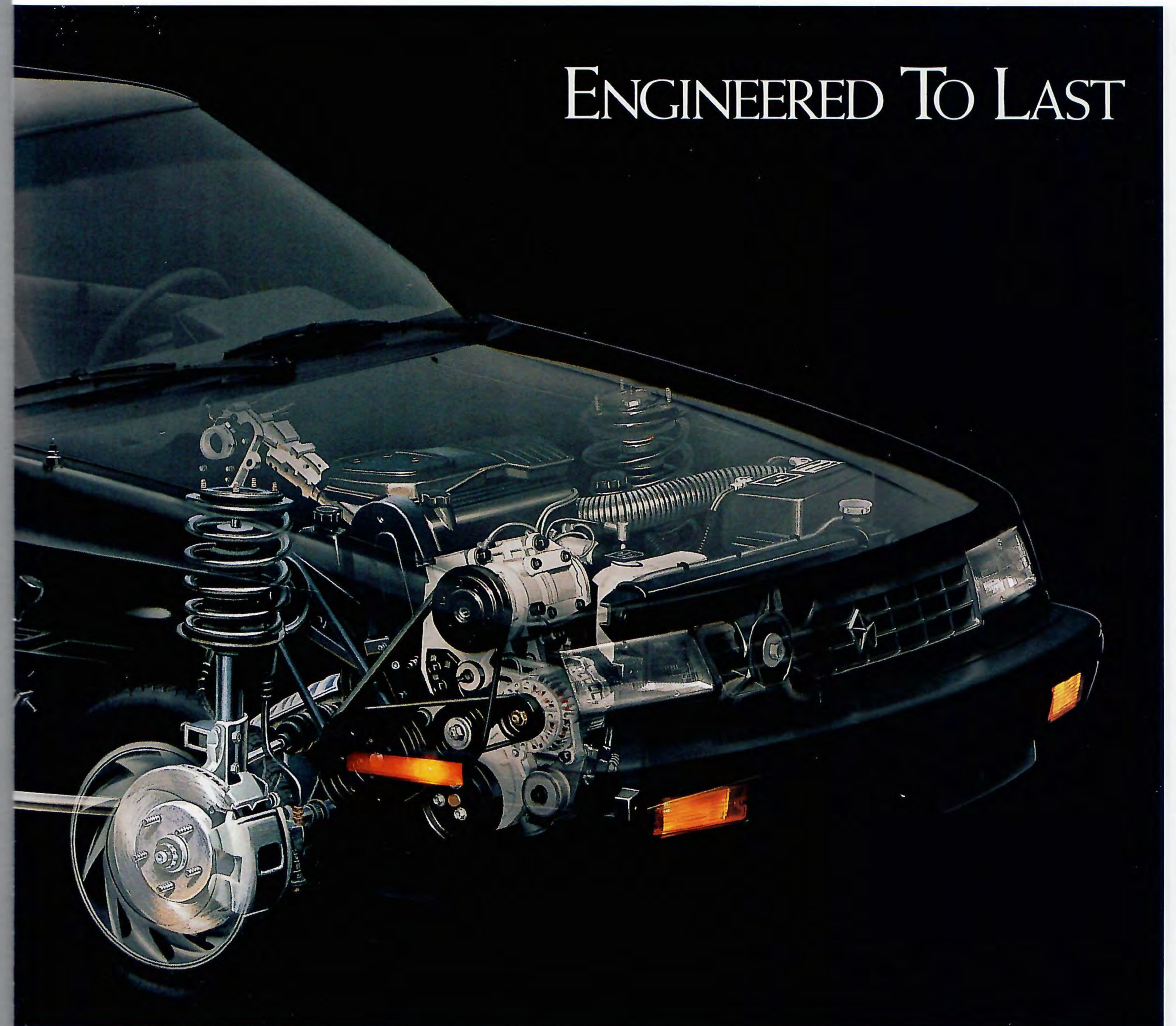
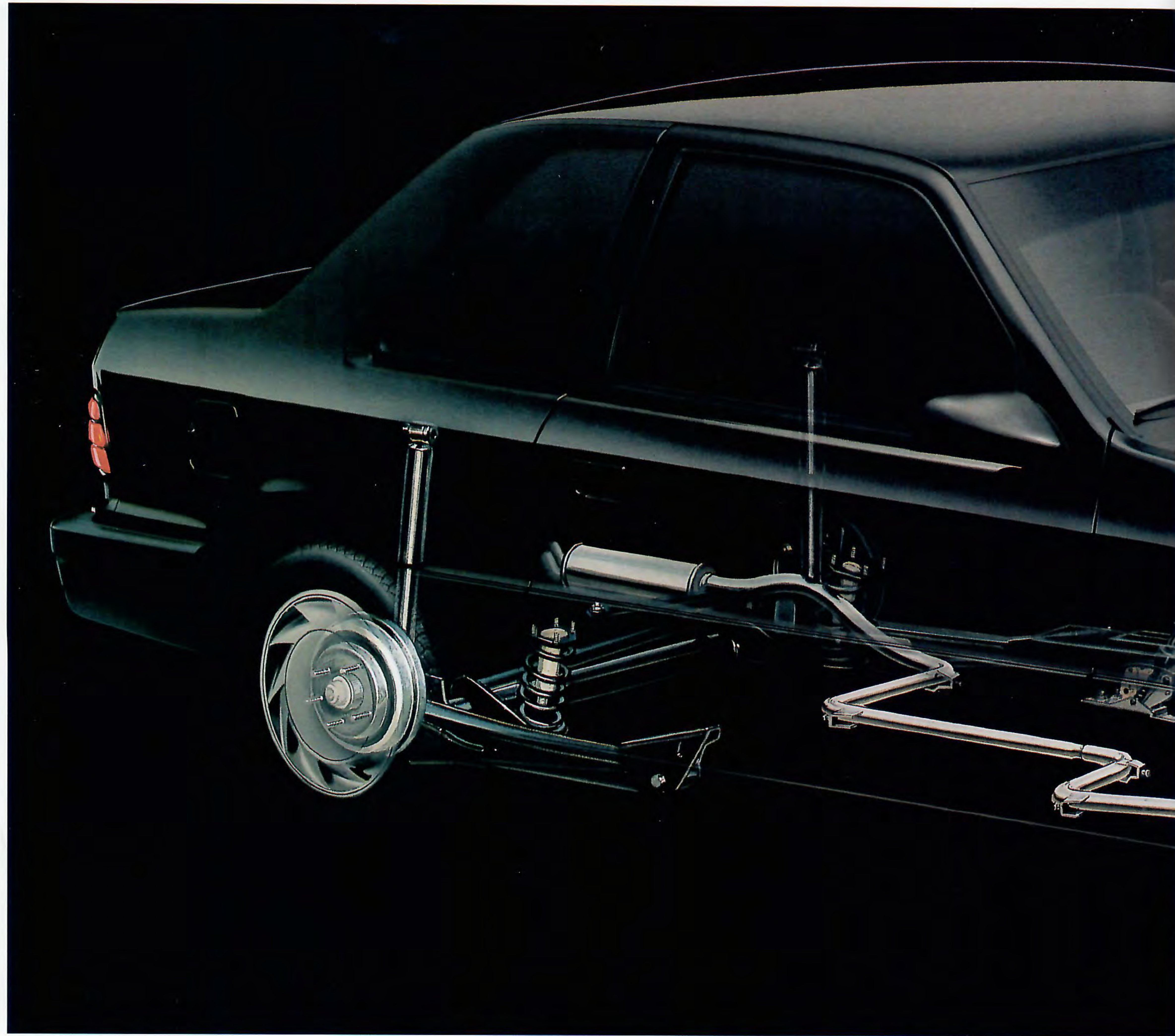

ENGINEERED TO LAST



Crash characteristics of vehicle body and chassis components are accurately measured through extensive collision testing. Computer simulation is another process for achieving the goal of maximum driver and passenger safety.

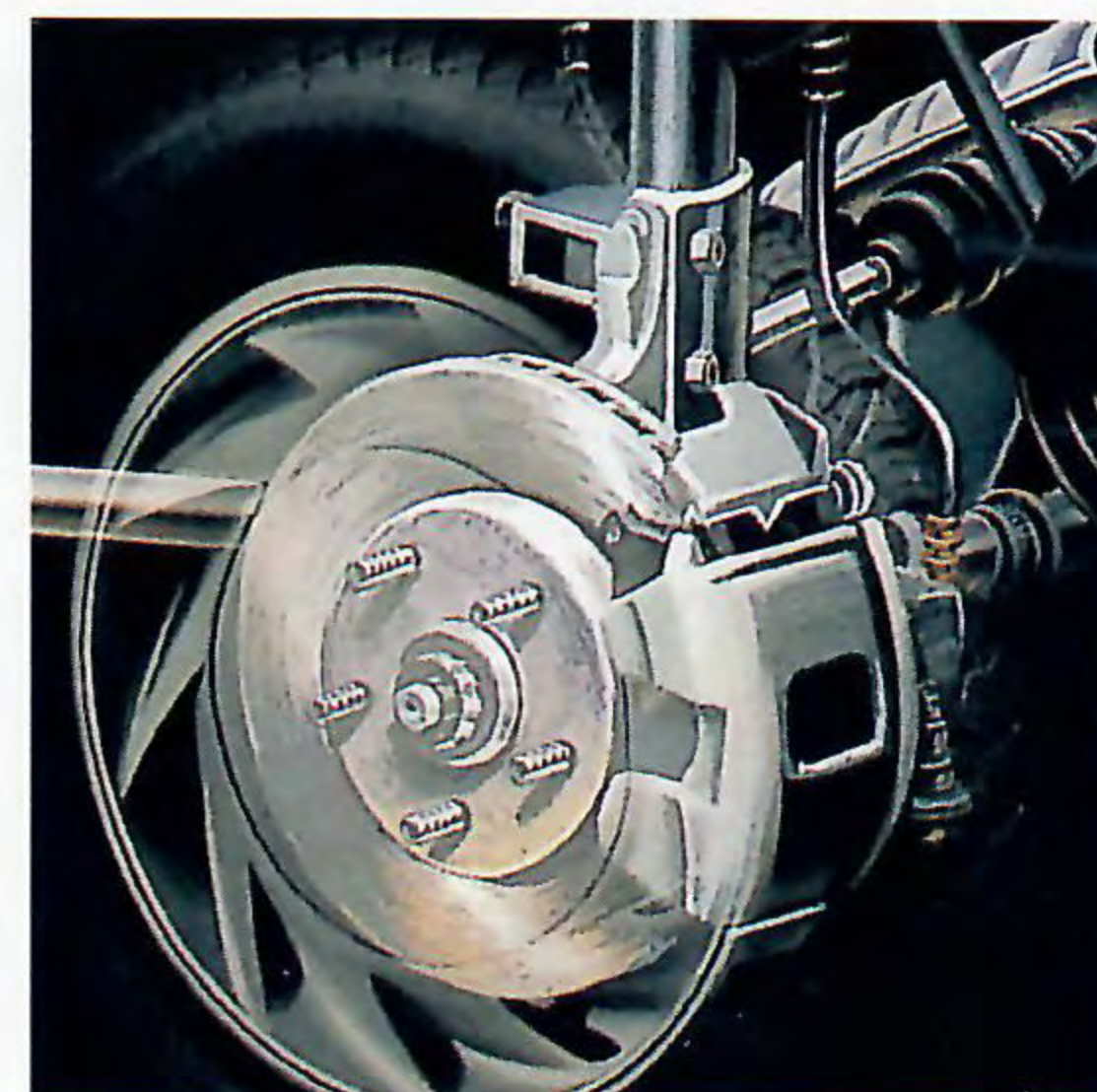

New for 1993, a vacuum-boosted antilock disc brake system is available on all Duster and Sundance models for increased stopping power.



To ensure long service life, Plymouth engine designs must pass demanding 800-hour endurance testing.

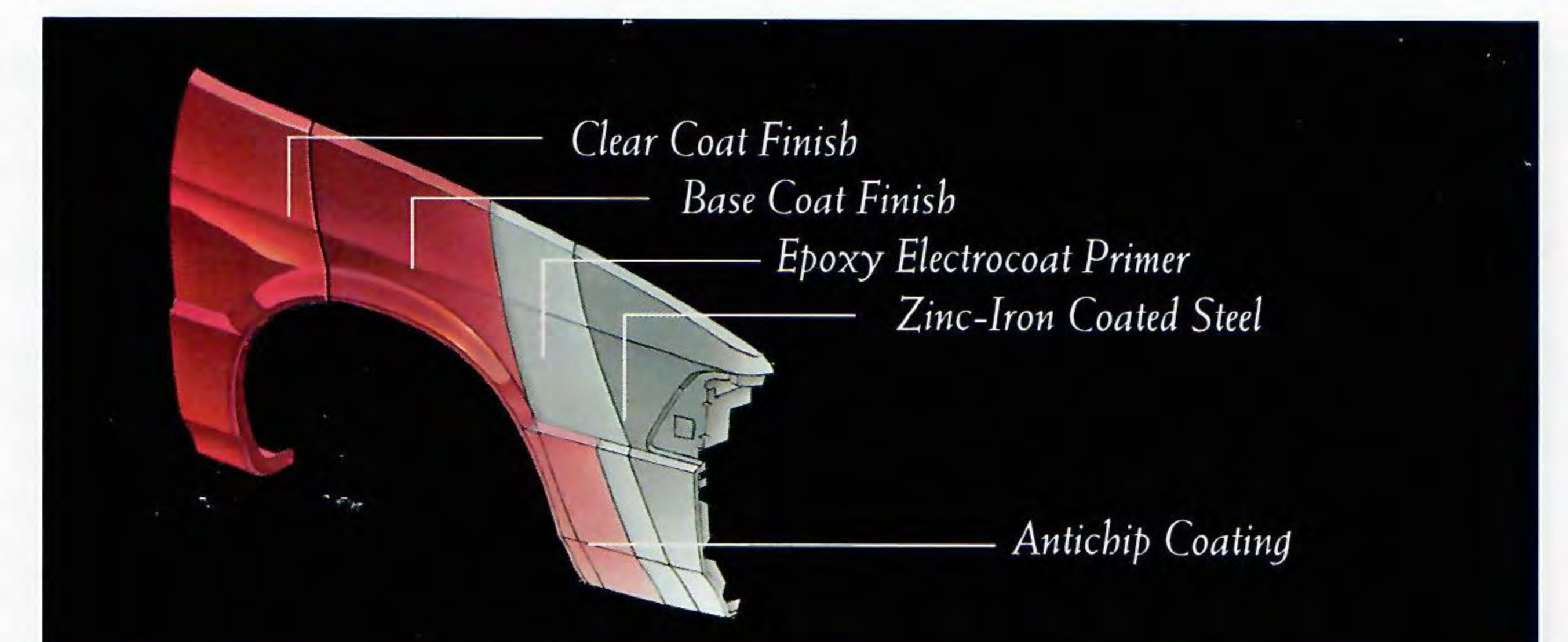

Anticorrosion protection: All body panels, except roof, are two-side galvanized/galvannealed, then three layers of primer, paint and clear antichip coatings are applied to create an environmentally resistant mirror finish.



Duster

SPORTY AND COMFORTABLE

Duster value includes one of the roomiest passenger compartments in its class, with comfort for five. Sporty-looking cloth with vinyl trim low-back, reclining front bucket seats are standard. The three-passenger rear bench seat with fold-down rear seatback can easily handle long cargo. The standard

mini floor console includes a front storage bin, floor shifter and rear cubby bin. Those who want extra style and convenience can choose the optional full center console (shown above) with front storage compartment, dual slide-out cup holders, cubby bin and center armrest that covers a storage area.



Duster's optional integral compact disc player features fast forward/rewind, track scan, pause, elapsed time display, five-band graphic equalizer, and much more.



Duster's instrument panel emphasizes driver control and convenience with a sporty flair. A tachometer and a new AM stereo*/FM stereo radio with cassette player or integral CD player and four-speaker system are optional. Also, air conditioning† and electronic speed control are available.

*Some AM stereo broadcasting may not be compatible with this radio.

†There are special engine cooling requirements for field-installed air conditioning. Failure to follow these requirements may invalidate warranty. See your dealer for details.



Sundance

SPIRITED BUT SMOOTH

A standard 2.2-liter SOHC (single overhead cam) EFI (electronic fuel-injected) engine means driving responsiveness in Sundance. For still livelier action, a 2.5-liter SOHC EFI 100-horsepower engine is available. Both offer increased power for '93 and can be teamed with a

standard five-speed manual overdrive transaxle or optional three-speed automatic. And the precision-feel suspension system works well with the power train. Components include gas-charged front dual path Iso-Struts, gas-charged rear shock absorbers, plus front and rear antisway

bars. Sundance's performance is complemented by a good-looking exterior. New 14-inch Bullet-design cast aluminum wheels (set of four) and other features are available for customizing Sundance through Customer-PreferredSM Packages (see page 17).



Sundance rewards its driver with nimble performance and a sense of fun behind the wheel.



A well-balanced front-to-rear weight distribution enables Sundance to handle lane-change and slalom maneuvers with confidence on the Chrysler test course. Directional stability is engineered into the car from the wheels up.



Sundance

AFFORDABLE AND VERSATILE

With a highly affordable price and a standard driver-side air bag, Sundance is a value-packed alternative to higher-priced imports. The impressive level of standard features includes power-assisted steering, power-assisted front disc and self-adjusting rear drum brakes,

front-wheel-drive engineering, a long-lasting stainless steel exhaust system, and reduced rolling resistance steel-belted radial tires (set of four) with all-season tread. Inside, Sundance offers the comfort of standard cloth-and-vinyl-covered door trim panels, full cargo compartment

carpet trim, and a luxury steering wheel with the integral air bag. The versatile liftback (shown right) provides 30.8 cubic feet of cargo-hauling ability with the rear seatback down. A removable rear shelf panel (not shown) conceals items stored in the cargo area.



An electronically tuned AM/FM stereo radio with cassette player, four speakers and integral digital clock is available.





Sundance

QUIET AND SAFE

Road and wind noises are reduced to minimal levels for a quieter ride. The reason? Premium sound insulation in many key areas of the vehicle, and a new molded dash-panel silencer pad, are now standard. For safety, Duster and Sundance offer standard features such as tether anchors

for child-seat restraints, antitheft liftback lock, and a center high-mounted rear stoplight. Plus options like tinted window glass to reduce glare and an electric rear window defroster* for better rearward visibility in inclement weather.

*Required on all passenger vehicles registered in New York State.

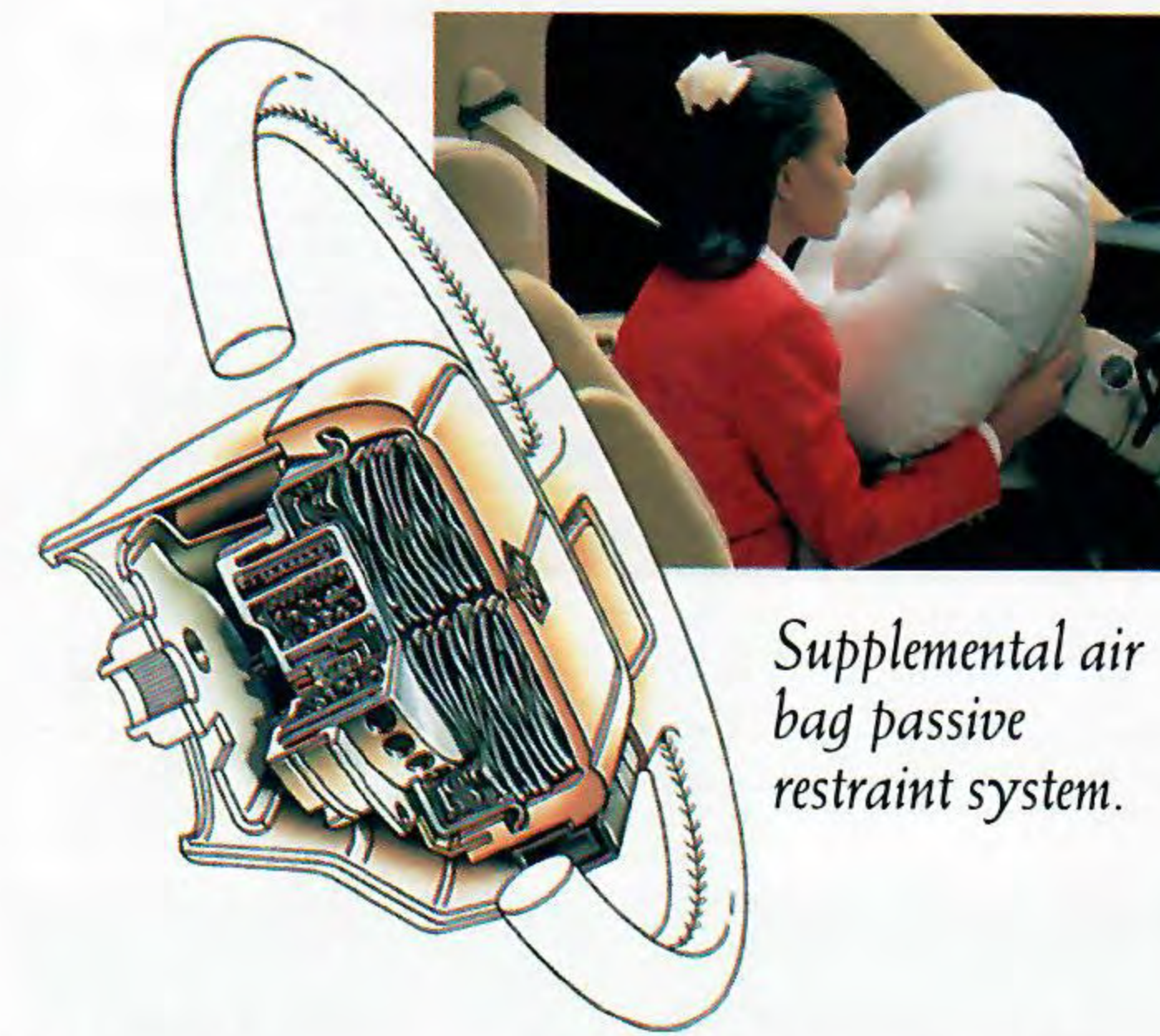

Supplemental air bag passive restraint system.

The air bag module is hidden inside the steering wheel hub. When impact sensors detect a front-end collision requiring air bag deployment, the air bag inflates in 50 milliseconds (about 1/10th of a second) to help protect the driver's head and chest, then partially deflates immediately.



Seat belt-cinching latchplate holds the driver, passengers or a child seat securely in position for maximum safety. Standard on front and rear three-point Unibelt restraint system.

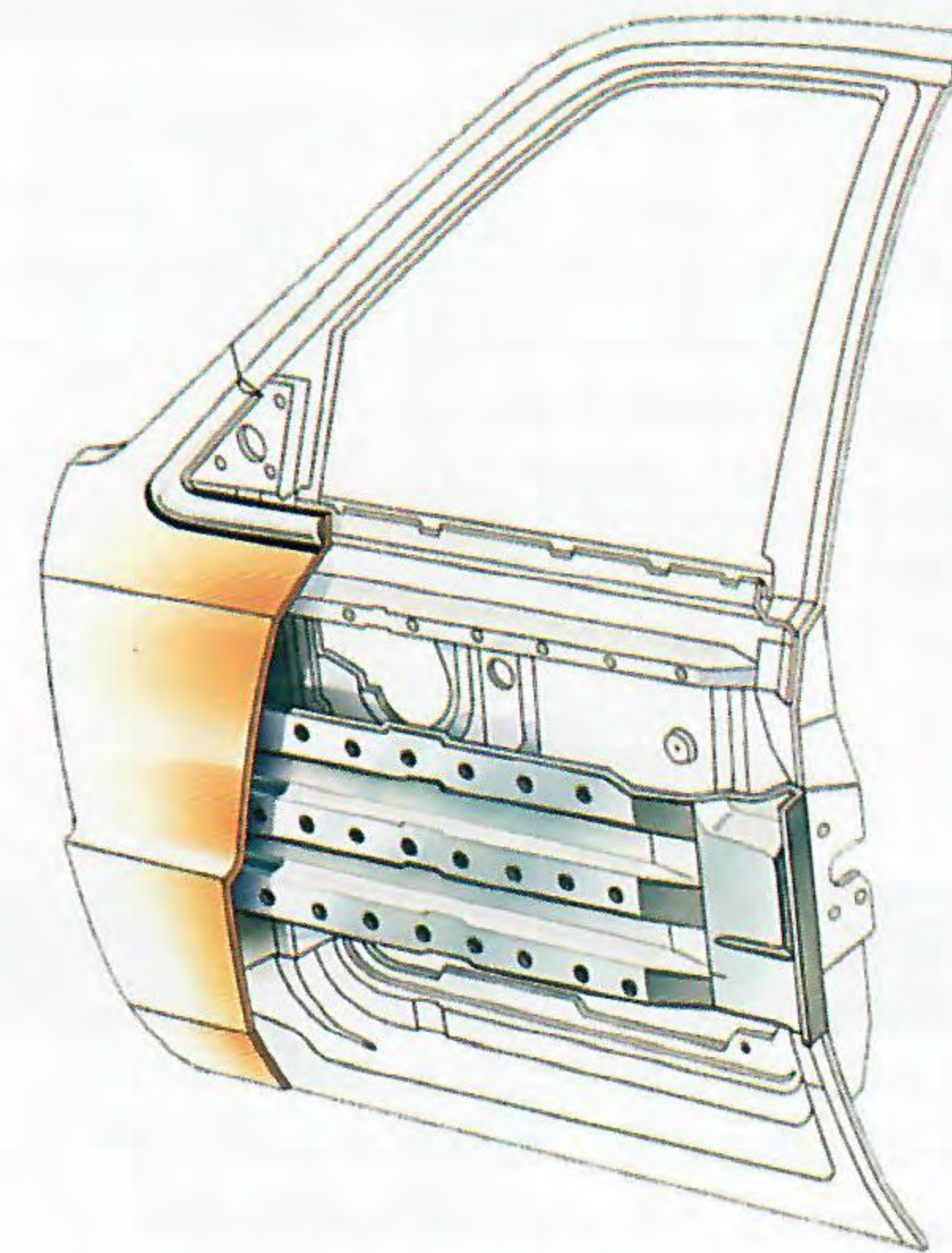

Tough standard steel-beam members add extra protection for occupants on both sides of the car.



Kinematic occupant computer modeling promotes greater interior safety for drivers and passengers. Engineers study and evaluate the various forces acting upon the human body during a collision, then design vehicle interiors that result in fewer injuries to occupants.



Computer-controlled "shaker" suspension simulator tests the suspension designs of all Plymouth vehicles. This advanced mechanism simulates and evaluates the action of road harshness and vibration on the suspension system and other vehicle components.

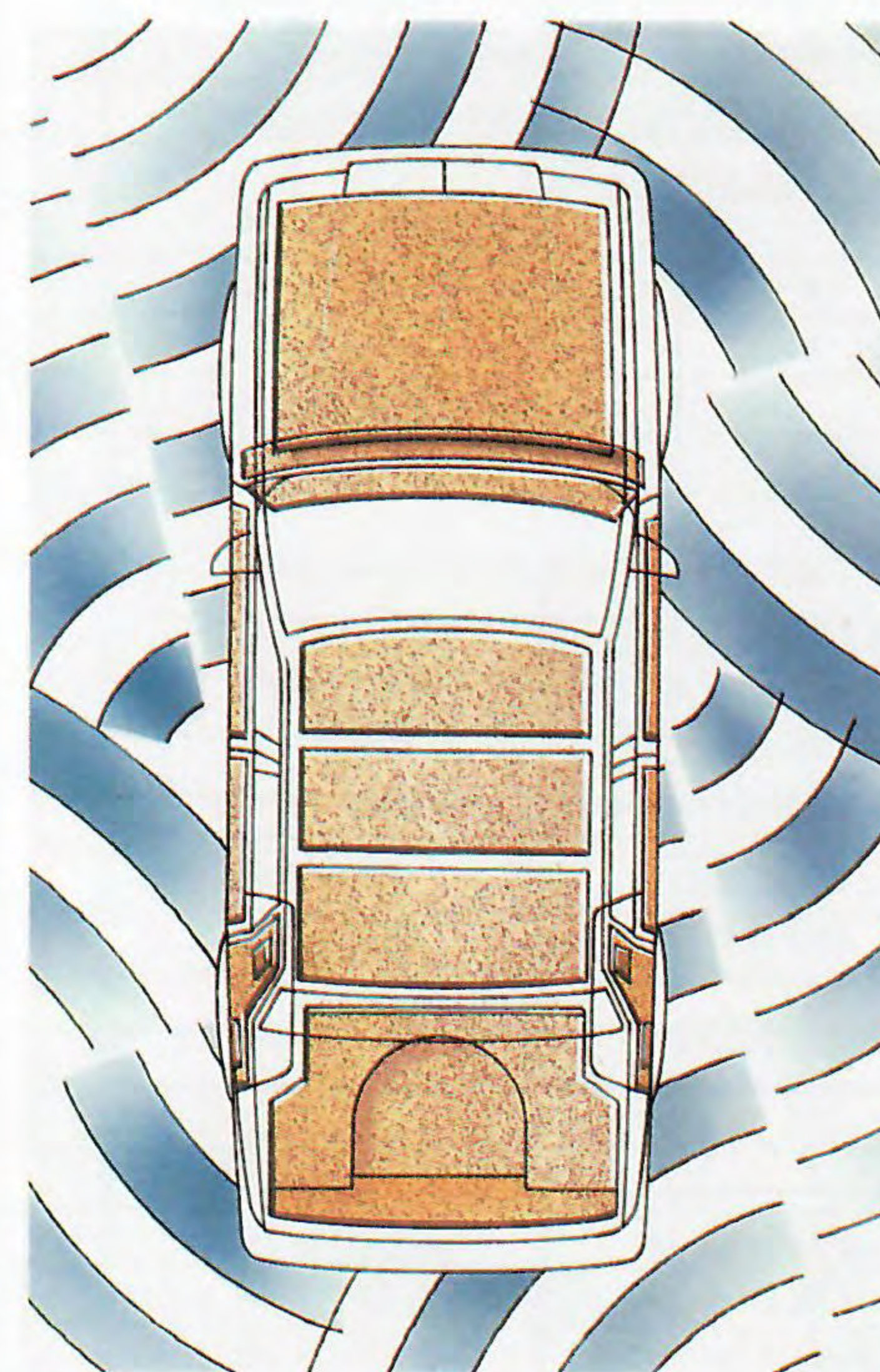

Noise and vibration reduction testing is conducted on power train, chassis, body and interior systems by engineers using sophisticated sound-level measuring equipment. Components are scientifically analyzed to achieve ongoing improvements that will ensure the quietest possible ride.

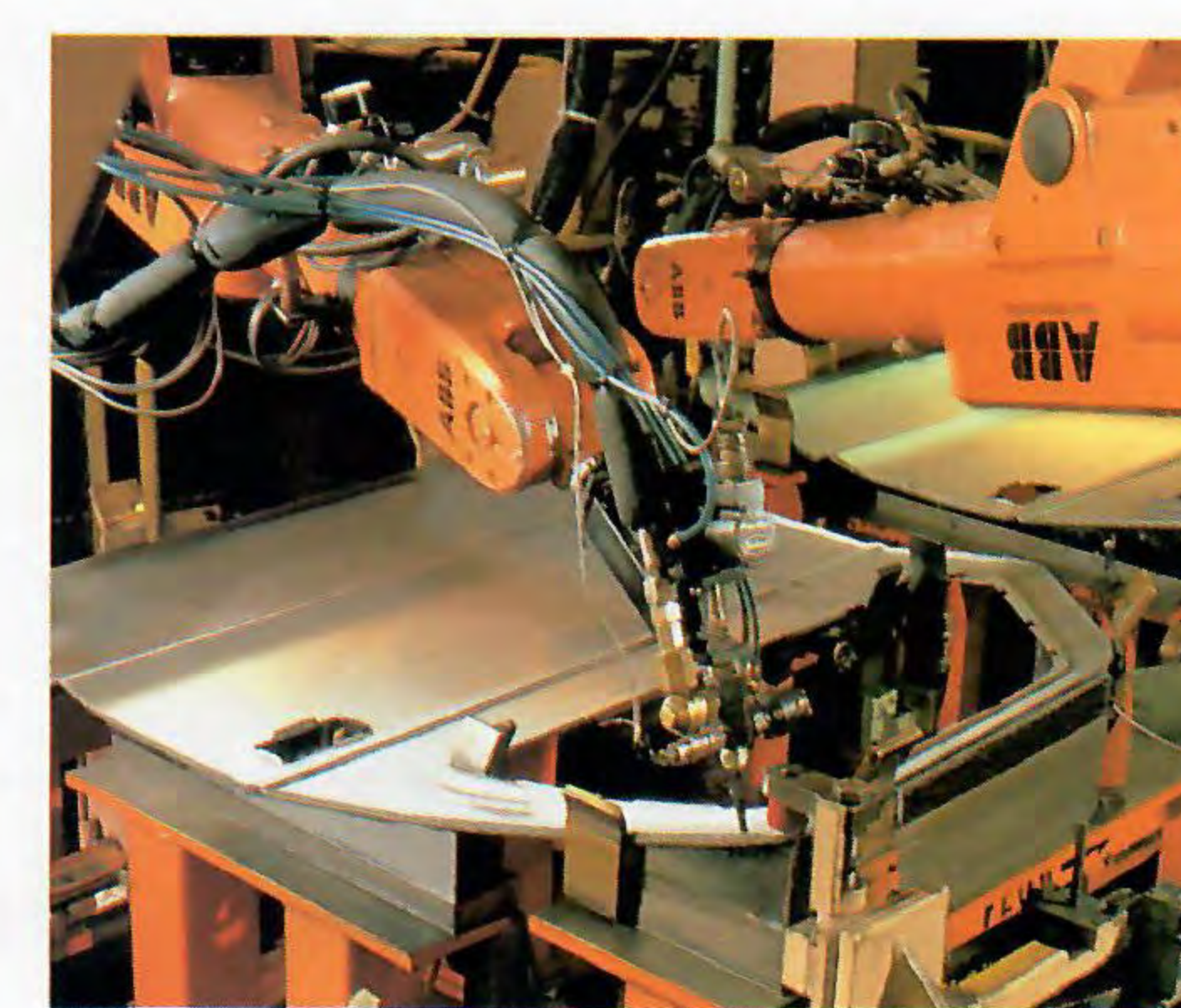

Strong epoxy adhesive material is applied by a robotic machine in a continuous bead that bonds vehicle door frames to their outer skins. Excellent structural strength, superior corrosion resistance, and reduced noise are the benefits.



Mopar's diagnostic service system offers Chrysler-Plymouth dealership customers today's most advanced technical service capability. Technicians use computerized procedures to quickly and accurately service your vehicle.

DIMENSIONS¹

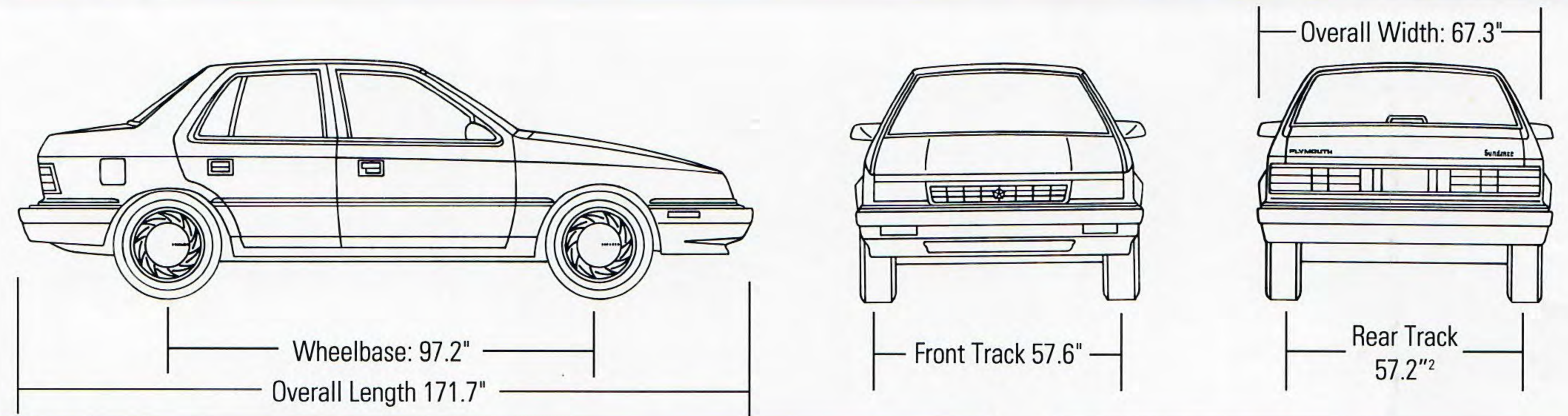

POWER TRAINS³

2.2-LITER SOHC EFI ENGINE
Sundance's standard 2.2-liter single overhead cam (SOHC) EFI four-cylinder engine features electronic fuel injection for efficient, dependable fuel metering. Engineering features include a fastburn cylinder head, overhead cam and roller tappets for smooth, consistent performance.

2.5-LITER SOHC EFI DUAL BALANCE-SHAFT ENGINE
A responsive 2.5-liter single overhead cam (SOHC) electronic fuel injection (EFI) engine is available on Sundance and Duster. It delivers greater torque for performance, electronic fuel injection for precise fuel metering, and counterrotating dual balance shafts that dampen engine vibration.

3.0-LITER OHC V6⁴ SMPI ENGINE
This smooth, powerful 3.0-liter OHC V6 SMPI engine is standard on Duster with features such as overhead camshaft (OHC) and sequential multipoint electronic fuel injection (SMPI). Engine develops a torque rating of 171 lb-ft @ 2,400 rpm. For maximum efficiency and performance, it's coupled with Plymouth's optional computer-controlled four-speed overdrive automatic transaxle. Shift safety interlock feature permits key removal only in "Park."

ENGINE CHARACTERISTICS	2.2-LITER SOHC EFI ENGINE <small>Standard on Sundance</small>	2.5-LITER SOHC EFI DUAL BALANCE-SHAFT ENGINE <small>Optional on Sundance/Duster</small>	3.0-LITER V6 ⁴ OHC MPI ENGINE <small>Standard on Duster</small>
TYPE	4-cylinder SOHC EFI	4-cylinder SOHC EFI	6-cylinder OHC SMPI
DISPLACEMENT	2.2-liter (135 CID)	2.5-liter (153 CID)	3.0-liter (181.4 CID)
BORE & STROKE	3.44" x 3.62"	3.44" x 4.09"	3.59" x 2.99"
TRANSAXLE AVAILABILITY	5-speed manual (2.68 OTGR): standard on Sundance model 3-speed automatic ⁵ (3.02 OTGR): optional on Sundance model	5-speed manual (2.68 OTGR): optional on Sundance and Duster models 3-speed automatic ⁵ (3.02 OTGR): optional on Sundance and Duster models	5-speed manual (2.68 OTGR): standard on Duster model only 4-speed electronic automatic (2.49 OTGR): optional on Duster model only
COMPRESSION RATIO	9.5:1	8.9:1	8.9:1
HORSEPOWER/SAE NET @ RPM	93 hp @ 4,800	100 hp @ 4,800	141 hp @ 5,200
TORQUE SAE NET @ RPM	122 lb-ft @ 3,200	135 lb-ft @ 2,800	171 lb-ft @ 2,400

OTGR = Overall Top Gear Ratio
¹Based on 1992 MVMA information.
²57.6" with 15" tires.
³Emission controls and testing required at extra cost on all vehicles registered in California; not available otherwise.
⁴Built by Mitsubishi Motors Corporation.
⁵With electromechanical torque converter.

DIMENSIONS

	SUNDANCE	DUSTER
Track		
—Front	57.6"	57.6"
—Rear	57.2"	57.2" ²
Curb Weight		
—Two-door	2,608 lb	2,672 lb
—Four-door	2,644 lb	2,757 lb
Turning Diameter	—(curb-to-curb).....36.2'	
Cargo Capacity	—With rear seatbacks up.....13.1 cu ft (four-door) 13.2 cu ft (two-door)	
	—With rear seatbacks down.....30.8 cu ft (four-door) 30.8 cu ft (two-door)	
Passenger Capacity	5	
Fuel Capacity	14 gal	

TIRES

SIZE	TYPE (Set of Four)	AVAILABILITY
P185/70R14	Steel-belted radial with all-season tread, black sidewall	Standard on Sundance
P195/60HR15	Steel-belted radial with all-season tread, black sidewall speed-rated	Standard on Duster

MILEAGE

Sundance: 27 EPA est. city mpg, 32 EPA est. hwy. mpg*
 Duster: 19 EPA est. city mpg, 28 EPA est. hwy. mpg*
 *Mileage figures based on 1993 figures for Sundance and Duster models with standard engine and five-speed manual overdrive transaxle.

TRAILER TOWING CAPACITY

2.2L engine.....	1,000 lb* w/manual transaxle 1,500 lb* w/auto. transaxle
2.5L engine.....	1,000 lb* w/manual transaxle
3.0L engine.....	2,000 lb* w/auto. transaxle

*Based on a load of two passengers and luggage.

CUSTOMER-PREFERREDSM PACKAGES

ENGINES	TRANSAXLES	SUNDANCE		DUSTER	
2.2L SOHC EFI 4-cyl.	5-Speed Manual	W	Y		
	3-Speed Automatic	W	Y		
2.5L SOHC EFI 4-cyl.	5-Speed Manual	W	Y	G	H
	3-Speed Automatic	W	Y	G	H
3.0L OHC MPI V6	5-Speed Manual			G	H
	4-Speed Automatic			G	H

PACKAGE CONTENTS				
Air Conditioning ¹ w/Tinted Glass*			•	•
Console—Floor-mounted center			•	•
Defroster ² —Rear window: electric*			•	•
Fascias—Color-keyed, front and rear, (Duster-unique)			•	S S
Fog Lamps				•
Horn—Dual-note				•
Instrument Panel Bezels—Color-keyed			•	
Light Package			•	•
Liftgate Release				•
Mats—Floor: front and rear			•	•
Mirrors—Dual outside manual remote			•	•
Mirrors—Visor vanity, driver and passenger			•	•
Moldings—Narrow bodyside: color-keyed			•	•
Radio—AM/FM stereo with two speakers			•	S S
Radio—AM/FM stereo cassette, four speakers			•	•
Speakers—Four			•	•
Stripes—Bodyside and deck lid			•	
Tachometer				•
Warning Chimes				•
Wheel Covers—14-inch Sport (set of four)			•	
Windshield Wipers—Intermittent			•	•

AVAILABLE OPTIONS					
Air Conditioning ¹ w/Tinted Glass*		0	P	0	P
Antilock Brakes—Four-wheel disc		0	0	0	0
California Emissions ³		0	0	0	0
Console—Overhead					0 ⁴
Defroster ² —Rear window: electric*		0	P	0	P
Liftgate Release—Remote			0		P
Light Package		0	P	0	P
Mats—Floor: front and rear		0	P	0	P
Mirrors—Dual outside manual remote		0	P	S	S
Mirrors—Dual outside power remote					0 ⁵
Power Door Locks			0	0	0
Power Driver Seat					0 ⁶
Power Windows					0 ⁷
Radio—AM/FM stereo with two speakers		0	P	S	S
Radio—AM/FM stereo cassette, four speakers		0	0	0	P
Radio—Premium AM stereo/FM stereo, cassette, equalizer, seek/scan, Infinity speaker system				0 ^{8,9}	0 ⁹
Radio—Premium AM/FM stereo/CD player, graphic equalizer, Infinity speaker system				0 ^{8,9}	0 ⁹
Speed Control ¹⁰ —Electronic		0	0	0	0
Steering Column—Tilt		0 ⁹	0	0 ⁹	0
Sunroof		0	0	0	0 ¹⁰
Tire—Conventional spare		0	0	0 ¹¹	0 ¹¹
Wheels—14-inch bullet cast aluminum (set of four)		0	0		
Wheels—15-inch Cathedral aluminum (set of four)				0	0
Windshield Wipers—Intermittent		0	P	0	P

S = Standard Equipment P = Included in Customer-PreferredSM Package listed above. 0 = Optional. Available only when corresponding Customer-PreferredSM Package is ordered. • = Included in Package. *Includes 90-ampere alternator.
¹There are special engine cooling requirements for field-installed air conditioning. Failure to follow these requirements may invalidate warranty. See your dealer for details. ²Required on all passenger vehicles registered in New York State. ³Required on all passenger vehicles registered in California. Not available otherwise. ⁴Not available with sunroof. ⁵Must have power door locks. ⁶Must have power windows, power mirrors, power door locks. ⁷Must have power mirrors, power door locks. ⁸Must have tilt steering column. ⁹Must have intermittent wiper. ¹⁰Not available with overhead console. ¹¹Includes aluminum wheel if aluminum wheel is ordered.

SAFETY FEATURES

- Air bag, driver-side
- Antitheft trunk lock
- Available four-wheel antilock disc brakes
- Backup lights
- Brake fluid pressure loss warning light (also serves as indicator when parking brake is applied)
- Child-protection rear door locks (four-door only)
- Double ball-joint rearview mirror mount
- Dual braking system with separate brake fluid reservoirs in the master cylinder
- Electric windshield washers
- Energy-absorbing front and rear bumpers
- Energy-absorbing front seatbacks
- Energy-absorbing instrument panel and sun visors
- Energy-absorbing steering column
- Fade-resistant front disc brakes
- Front seat head restraints
- Glare reduction measures for instrument panel, steering wheel, and windshield wipers
- Hazard warning flasher system
- Ignition and steering column lock
- Impact-actuated fuel supply shutdown relay
- Inside rearview mirror
- Interlocking door latches
- Key-left-in-ignition reminder
- Non-override door locks (except driver's door)
- Recessed inside door release handles
- Reinforced windshield header and roof
- Resilient window crank knobs
- Safety-Rim wheels
- Seat belt reminder system
- Seatback inertia latches on folding front seats (two-door only)
- Shatter-resistant glass
- Side door beams
- Side marker lights and reflectors
- Turn signals with lane-change feature

STANDARD AND OPTIONAL EQUIPMENT

FUNCTIONAL

	SUNDANCE	DUSTER
Alternator—75-ampere	S	NA
Alternator—90-ampere	P	S
Battery—500-ampere; maintenance-free	S	O
Battery—600-ampere; maintenance-free	O	S
Brakes—Four-wheel antilock disc	O	O
Brakes—Vented front disc and self-adjusting rear drum: power-assisted	S	S
Electronic Ignition, Fuel Injection, and Voltage Regulator	S	S
Engine—2.2-liter SOHC EFI four-cylinder	S	NA
Engine—2.5-liter SOHC EFI four-cylinder	O	O
Engine—3.0-liter V6 OHC MPI	NA	S
Exhaust System—Stainless steel	S	S
Front-Wheel Drive	S	S
Fuel Filler Cap—Tethered	S	S
Fuel Tank—14-gallon	S	S
Fuse Box—Easy access: contains spare fuse holder and fuse removal tool	S	S
Headlights—Halogen: aerostyle with stone-resistant plastic lenses	S	S
Jack—Scissors-type	S	S
Liftgate Release—Remote, cable-operated	O	P
Steering—16: 1 ratio, rack-and-pinion: power-assisted	S	S
Steering Column—Tilt	O	O
Speed Control—Electronic	O	O
Suspension—Precision-handling: gas-charged front position-sensitive struts and gas-charged rear shock absorbers; front and rear antisway bars	S	S*
Tire—Spare: compact	S	S
Tire—Spare: conventional ¹	O	O
Tires—P185/70R14 reduced rolling resistance steel-belted radial, all-season black sidewall (set of four)	S	NA
Tires—P195/60HR15 performance, reduced rolling resistance steel-belted radial, black sidewall, speed-rated	NA	S
Transaxle—Five-speed manual with overdrive	S	S
Transaxle—Three-speed automatic	O	O
Transaxle—Four-speed electronic automatic	NA	O

EXTERIOR

Bumpers—Energy-absorbing, front and rear	S	S
Corrosion Protection—Antichip protective coating on lower body panels; extensive use of galvanized steel	S	S
Door Handles—Body color, (black on Sundance)	S	S
Fascias—Black: front and rear	S	NA
Fascias—Body color: (Duster-unique)	P	S
Glass—Tinted: liftback only (four-door)	S	S
Glass—Tinted: liftback and rear quarter windows (two-door)	S	S
Grille—Bright	S	NA
Grille—Body color	NA	S
Hood—Counterbalanced with insulation pad and inside release	S	S
Hood—Power bulge	NA	S
Mirror—Exterior: left, manual remote, black	S	NA
Mirrors—Exterior: dual manual remote, black	O	S
Mirrors ² —Exterior: dual power	NA	O
Moldings—Black, narrow belt	S	S
Moldings—Black, rear window and windshield	S	S
Moldings—Black, narrow, bodyside	S	NA
Moldings—Color-keyed, bodyside ground effects	NA	S
Rear Spoiler—Body color	NA	S
Sunroof—Manual flip-up	O	O
Wheels—Argent-painted steel wheels black center caps (set of four)	S	NA
Wheels—Cast aluminum (set of four)	O	O
Wheel Covers—Sport: 14-inch (set of four)	P	NA
Wheel Covers—Triad: 15-inch (set of four)	NA	S

INTERIOR

Air Bag—Steering wheel-mounted	S	S
Air Conditioning ³ —Includes tinted glass	O	O
Ash Receiver—Front	S	S
Brake—Parking: foot pedal-operated	S	S

INTERIOR (cont.)

	SUNDANCE	DUSTER
Carpeting—Full cargo compartment dress-up: Charcoal	S	S
Carpeting—Passenger compartment: color-keyed	S	S
Cellular Phone—Portable, dealer-supplied	O	O
Chimes—Reminders: fasten seat belt; headlights on; key-in-ignition	NA	P
Cigar Lighter—With illuminated socket	S	S
Console—Mini: includes front and rear storage bins, color-keyed	S	S
Console—Full: includes storage, cup holders and padded armrest	NA	P
Console—Overhead: includes reading lamps, storage, compass and outside temperature readout	NA	O
Defroster ⁴ —Liftgate, electric	O	O
Demisters—Side window	S	S
Door Locks—Child-protection (on four-door rear doors only)	S	S
Door Locks—Power	O	O
Door Trim Panels—Cloth and vinyl covered	S	NA
Door Trim Panels—Cloth/carpet covered	NA	S
Floor Mats—Front and rear	O	O
Glove Box—Latching	S	S
Headliner—Cloth-covered	S	S
Heater and Defroster—With bi-level ventilation	S	S
Horn—Dual-note	NA	P
Horn—Single-note	S	S
Instrument Cluster—Electromechanical: includes speedometer, odometer, trip odometer, gauges for electrical systems voltage, engine coolant temperature, fuel level; warning lights for check engine, high beam headlights on, low engine oil pressure, parking brake on, fasten seatbelts, air bag, emissions, ABS (if equipped)	S	S
Insulation—Premium sound	S	S
Light Group Package—Includes ash receiver light, cargo compartment light, glove box light, rear door dome light switch (four-door only), underhood light	P	P
Lights—Cigar lighter, dome, ignition switch with time delay	S	S
Mirror—Interior: rearview day/night	S	S
Multifunction Control Lever—Mounted on steering column: includes controls for turn signals with lane-change feature, day/night flash/pass feature, headlight dimmer windshield wiper/washer	S	S
Radio—AM/FM stereo radio with integral digital clock and two speakers	O	S
Radio—AM/FM stereo with cassette player, integral digital clock and four speakers	O	O
Radio—Premium AM stereo ⁵ /FM stereo, electronic tuning, graphic equalizer, premium cassette, seek-and-scan, Infinity speakers	NA	O
Radio—Premium AM/FM stereo/ CD player, graphic equalizer, Infinity speakers	NA	O
Seat ⁶ —Driver-side, power	NA	O
Seatback—Rear, folding with three-point color-keyed outboard seat belts	S	S
Seats—Front, reclining cloth with vinyl trim, contoured low-back bucket with color-keyed three-point seat belts	S	S
Seat Track—Two-way adjustable	S	S
Shelf Panel—Removable, carpeted, pivoting	S	S
Steering Wheel—Luxury, with air bag	S	S
Tachometer—Instrument cluster	NA	P
Tether Anchor—Child restraint	S	S
Visor Vanity Mirrors—Right and left	P	P
Windows ⁷ —Power	NA	O
Windshield Wipers—Deluxe variable intermittent wipe feature with wet arm washers	O	O
Windshield Wipers—Two-speed with wet arm washers	S	S

S = Standard. NA = Not available. O = Optional. Some items may also be available in Customer-PreferredSM Packages. See Customer-PreferredSM Packages and "Available Options" for availability. P = Package only. See Customer-PreferredSM Packages for availability.

*Includes higher spring rates (Sport Suspension)

¹Includes aluminum wheel when aluminum wheel is ordered on Duster only.

²Requires center console and power door locks.

³There are special engine cooling requirements for field-installed air conditioning. Failure to follow these requirements may invalidate warranty. See your dealer for details.

⁴Required on all passenger vehicles registered in New York State.

⁵Some AM stereo broadcasting may not be compatible with this radio.

⁶Requires center console, power door locks, mirrors and windows.

⁷Requires power mirrors and door locks.

EXTERIOR COLORS

INTERIOR COLORS

	CHAMPAGNE	MEDIUM QUARTZ
	Sundance Duster	Sundance
Wildberry Pearl Coat (Sundance and Duster)		
	Sundance	Sundance Duster
Radiant Red Clear Coat (Sundance and Duster)		
		Sundance
Raspberry Red Pearl Coat (Sundance, extra cost)		
		Sundance Duster
Aqua Pearl Coat (Sundance, two-door Duster only)		
	Sundance	Sundance
Black Clear Coat (Sundance)		
	Sundance Duster	Sundance
Emerald Green Pearl Coat (Sundance and Duster)		
	Sundance	Sundance Duster
Bright White Clear Coat (Sundance and Duster)		
		Sundance
Electric Blue Metallic Clear Coat (Sundance, extra cost)		
	Sundance	Sundance
Light Driftwood Satin Glow (Sundance, extra cost)		

Note: Due to printing limitations, the colors shown will vary slightly from actual hues. See your Plymouth dealer for accurate color chips. Clear Coat finish is standard on every 1993 passenger car built by Chrysler Corporation.



The Owners Choice Protection Plan
Now you have a choice of protection plans to suit your needs. When you purchase a new 1993 Plymouth Sundance or Duster you can choose either of the two limited warranty plans described below.

3/36 Bumper-To-Bumper Limited Warranty The three-year or 36,000-mile Basic Bumper-to-Bumper Limited Warranty covers the entire vehicle including power train (excludes adjustments, tires, normal wear items and maintenance). No deductible applies. Restrictions apply. See your dealer for a copy of this limited warranty.

OR: 7/70 Power Train Limited Warranty Upon expiration of the 12-month or 12,000-mile Basic Limited Warranty, coverage is extended on power train components to seven years or 70,000 miles. No deductible applies. Restrictions apply. See your dealer for a copy of these limited warranties.

7/100,000 Anticorrosion Limited Warranty In addition, all Chrysler Corporation vehicles are covered by the 7/100,000 Outer Panel Anticorrosion Limited Warranty. Your dealer will repair or replace at no charge outer body sheet metal panels found to have developed perforation (rust-through) in normal use up to seven years or 100,000 miles. No deductible applies. See your dealer for a copy of the warranty.



We sell satisfaction.

Additional peace-of-mind protection for vehicle owners is available through optional Chrysler Service Contracts. These services are available in a variety of time and mileage combinations to meet your particular driving needs.



Chrysler Credit Financing
Chrysler Credit offers a variety of finance programs that can help make your new Plymouth Sundance or Duster even more affordable. These flexible finance and lease programs can be tailored to suit your budget and your lifestyle. They include Gold Key Plus, College Graduate Plans, Gold Key Lease, Retail Financing and other special payment plans. Ask your salesperson for details.



Mopar Accessories Here is a list of the more popular Mopar accessories available for Plymouth Sundance or Duster. See your dealer for a complete list and availability by model.

- Electronic Vehicle Security II System/Keyless Entry
- Deck Lid Spoiler
- Bodyside Graphics Packages
- CD Player
- Molded Splash Guards



Chrysler Cellular Systems For 1993, Chrysler will be offering a selection of dealer-installed/ supplied cellular phones in several models to enhance the available optional equipment list. Ask your dealer for details. OKI[®] and Panasonic warrant and service these products. Restrictions apply. Ask your dealer for details and a copy of these limited warranties.



Physically Challenged Assistance Program Cash reimbursement of up to \$500 for purchase and installation of adaptive driving aids or passenger equipment on new 1993 Chrysler Corporation cars, trucks or vans. For further information, contact your dealer or the PHYSICALLY CHALLENGED RESOURCE CENTER at 1-800-255-9877.

All product illustrations and specifications are based upon current information at the time of publication approval. Although descriptions are believed correct, complete accuracy cannot be guaranteed. Chrysler Corporation reserves the right to make changes from time to time, without notice or obligation, in prices, specifications, colors and materials, and to change or discontinue models. See your dealer for the latest information.

Plymouth and MOPAR are registered trademarks, and Sundance is a trademark of Chrysler Corporation.

Buckle up for safety.



ADVANTAGE: SUNDANCE
A DIVISION OF THE CHRYSLER CORPORATION

