

Responsible. Reliable. **Ready to join the family.**

At Subaru, we're committed to building a lasting, rewarding relationship with you and the world we share. We start by building our vehicles to last—it's why 97% of Outback models we've sold in the last 10 years are still on the road today.¹ We also share your desire for a cleaner, greener world. Select 2015 Outback 2.5i models achieve Partial Zero Emission Vehicle—PZEV²—status, because of their exceptionally low emissions. What's more, in 2004, Subaru of Indiana Automotive, Inc., (SIA) became the first manufacturing facility in the U.S. to reach zero-landfill status—nothing from its manufacturing efforts ever goes into a landfill. Subaru is also headquartered in a zero-landfill office in Cherry Hill, NJ.

Outback

2015



¹ Based on IHS Automotive: Polk U.S. Total Registrations MY2004–2013.

² 2015 Subaru Outback 2.5i models achieving a Partial Zero Emission Vehicle (PZEV) rating by the California Air Resources Board are available in all 50 states. Only those registered in California, Connecticut, Maine, Maryland, Massachusetts, New Jersey, New York, Rhode Island and Vermont will be eligible for the 15 years/150,000 mile emission warranty. Delaware, Oregon, Pennsylvania and Washington vehicles are not covered under PZEV emissions control warranty. See your warranty maintenance booklet for additional information.

These brochures were printed with vegetable-based inks and produced using a "Green Printing Process." The Forest Stewardship Council® (FSC®) is an international organization that brings people together to find solutions which promote responsible stewardship of the world's forests and environments.

By producing these brochures in a green way rather than by traditional methods, we saved 54 trees preserved for the future; 24,941 gallons of wastewater flow saved; 1,670 lbs solid waste not generated; 4,599 lbs net greenhouse gases prevented; 24,000,000 BTUs energy not consumed. Calculations provided by Environmental Paper Network. FSC® is not responsible for any calculations on saving resources by choosing this paper.

This brochure is printed in the U.S.A. on 10% recycled paper. ©2014 Subaru of America, Inc. 150BK.SRB.525 (S-15238, 90K, 7/14, CG)

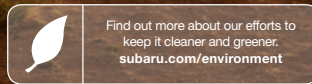

Love. It's what makes a Subaru, a Subaru.



Built to take you to the place you've never been.



Make every adventure count.

The 2015 Subaru Outback

The 2015 Outback helps you seize every free moment with a plethora of standard drop-everything-and-go features. Forget the aftermarket, every Outback comes standard with retractable roof cross bars with tie-downs, so you'll always arrive fully geared up. Also a standard feature, Subaru Symmetrical All-Wheel Drive featuring push-button X-MODE® with Hill Descent Control helps you conquer rougher terrain. When you want to spend more time adventuring and less time preparing, there's no other choice. With the Outback, versatility comes standard.



Efficient

The standard **SUBARU BOXER®** engine gives you up to **33 highway MPG**,¹ making it the most fuel-efficient midsize crossover in America.²



Capable

Subaru **Symmetrical All-Wheel Drive** comes standard, as does **X-MODE® with Hill Descent Control**, and the best ground clearance of any midsize crossover.³ Never fear the road less traveled.



Versatile

With standard **60/40 reclining rear seats**, a surprisingly spacious **108.1 cu. ft. interior**⁴, and an **available power rear gate**, the Outback is adventure-ready, just pack up and go.



Safe

To alert you of potential trouble and help you avoid it, there are a wealth of available features, including the acclaimed **EyeSight® driver assist technology**⁵, **Blind-Spot Detection** and **Rear Cross-Traffic Alert**.⁶

¹ EPA estimated fuel economy for 2015 Outback 2.5i at 33 highway MPG. Actual mileage may vary.

² Based on EPA estimated highway fuel economy for 2015 model vehicles within the IHS Automotive, Polk Non-Luxury Midsize CUV segment.

³ Based on ground clearance information from OEM websites and Edmunds.com for 2015 model vehicles within the IHS Automotive, Polk Non-Luxury Midsize CUV segment.

⁴ Without available moonroof.

⁵ EyeSight is a driver assist technology which may not operate optimally under all driving conditions. The driver is always responsible for safe and attentive driving. System effectiveness depends on many factors such as vehicle maintenance, weather and road conditions. See Owner's Manual for complete details on system operations and limitations. Please remember to turn off EyeSight when going through a carwash. Available on select models beginning Fall 2014.

⁶ Blind-Spot Detection, Lane Change Assist and Rear Cross-Traffic Alert are systems designed to assist the driver by monitoring the rear and side areas of the vehicle during a lane change or reversing and are not a substitute for safe and attentive driving.

Ready for anything. Just like you.

Versatile and Capable

Standard **Subaru Symmetrical All-Wheel Drive** and **8.7 inches** of ground clearance gives the Outback SUV-level capability in a crossover package. It's almost in a class of its own with another standard feature: **X-MODE® with Hill Descent Control**—which provides added control and enhanced confidence over rougher terrain at the push of a button. And you'll always arrive fully geared up, thanks to standard **retractable roof cross bars** and tie-downs, **108.1 cubic feet** of interior volume¹, **60/40 folding rear seats**, and an available **power rear gate** with height memory.

Powerful

Whether you go with the **33 MPG² 2.5-liter SUBARU BOXER®** engine, or the smooth and powerful **256-horsepower 3.6R**, you better get used to crossing items off your "wildest adventures" list.

¹ Without available moonroof.
² EPA estimated fuel economy for 2015 Outback 2.5i at 33 highway MPG. Actual mileage may vary.



Power Rear Gate



One-touch Folding Rear Seats

All you need on the inside
after a day on the outside.



Auto-dimming Mirrors with Approach Light

Make it easier—and safer—to come and go with the available Exterior Auto-dimming Mirrors with Approach Light.¹

When the doors are opened or unlocked with the key fob, LED lights on the side-view mirrors will help light the way, casting light on all four doors and the ground near the vehicle.

They can also help reduce headlight glare in traffic. When the Interior Auto-dimming Rearview Mirror detects excessive light from the rear of the vehicle, the side-view mirrors automatically dim, helping to keep the light out of your eyes. The brighter the light, the dimmer the mirrors and the better you'll be able to see.

¹ Exterior Auto-dimming Mirrors with Approach Light are accessory equipment. Requires Interior Auto-dimming Rearview Mirror.



Not Dimmed



Dimmed



Infotainment System



Control and Convenience Within Reach



2015 Outback

Refined Interior

There's a lot to enjoy in the Outback. The available full-color, LCD multifunction display gives you access to helpful information such as fuel economy, vehicle settings and the available EyeSight® driver assist system.¹

Plus the available high-res touchscreen navigation system helps you find your way, while the SUBARU STARLINK™ infotainment system offers safe access to Aha,[™] Pandora,[®] iHeartRadio,[®] podcasts, internet radio, apps and more.²

¹ EyeSight is a driver assist technology which may not operate optimally under all driving conditions. The driver is always responsible for safe and attentive driving. System effectiveness depends on many factors such as vehicle maintenance, weather and road conditions. See Owner's Manual for complete details on system operations and limitations. Please remember to turn off EyeSight when going through a carwash. Available on select models beginning Fall 2014.
² Compatible smartphone and applications required. For applications to operate, latest version of each application is required. Data provided by smartphone is displayed on the audio system screen. Some state laws prohibit the operation of handheld electronic devices while operating a vehicle. Smartphone apps should only be launched when vehicle is safely parked. Your wireless carrier's rates may apply.

Built for those who savor the journey.

Outback 3.6R Limited with Warm Ivory Leather.

The most luxurious Outback yet.

Sometimes getting there takes time. Inside the Outback, you'll find a place you won't mind waiting. Step inside the luxurious 108.1 cubic-foot cabin¹, and you'll find versatility and comfort from front to back. The available 10-way adjustable driver's seat with 2-position memory will keep you focused and content, while the supple-yet-supportive reclining rear seats with 60/40 split-folding functionality provide first-class treatment for both passengers and cargo alike.

¹ Without available moonroof.



A vigilant safety feature that gives peace of mind to every drive.

Pre-Collision Braking



A driver ahead unexpectedly hits the brakes or cuts you off. EyeSight^{®1} warns you, applies the brakes to help avoid it, and at lower speeds can even help you stop your Subaru.

Adaptive Cruise Control

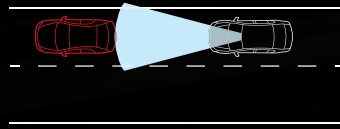

Traffic doesn't always flow, so EyeSight[®] doesn't only keep a set speed. The system looks ahead and helps the Subaru automatically adjust to keep your distance, even in stop-and-go highway traffic.

Pre-Collision Throttle Management



If you put the car in Drive instead of Reverse and EyeSight[®] sees an object in your path, it cuts power to help you avoid accelerating into it.

Lane Departure and Sway Warning

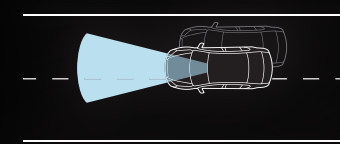

You accidentally drift to the edge of your lane and begin to cross into another. EyeSight[®] watches for lane markers and chimes to warn you before you leave your lane.



1 EyeSight is a driver assist technology which may not operate optimally under all driving conditions. The driver is always responsible for safe and attentive driving. System effectiveness depends on many factors such as vehicle maintenance, weather and road conditions. See Owner's Manual for complete details on system operations and limitations. Please remember to turn off EyeSight when going through a carwash. Available on select models beginning Fall 2014.

2 Based on 2014 EyeSight[®] systems tested by the Insurance Institute for Highway Safety (IIHS).

"The 2014 Subaru Outback earned the highest possible front crash prevention rating by IIHS when equipped with Subaru EyeSight."²

- Insurance Institute for Highway Safety (IIHS)



11 | 2015 Outback

Outback 2.5i Limited in Twilight Blue Metallic with optional equipment.

Better at what **Subaru** does best.

Enhanced Safety Features

With more IIHS Top Safety Picks than any other brand, we found ways to make the 2015 Outback even better at protecting what's inside. It offers standard features like a Rear-Vision Camera and eight airbags, including new front-seat cushion airbags that help keep occupants in place in the event of a crash.¹ AWD capability means you'll have control, even in unfavorable weather, and your ability to avoid accidents is enhanced by Vehicle Dynamics Control with Active Torque Vectoring. There are also new available features like Blind-Spot Detection with Lane Change Assist and Rear Cross-Traffic Alert.²



13 | 2015 Outback



Rear Cross-Traffic Alert

The new Rear Cross-Traffic Alert uses radar sensors to help warn you of traffic approaching from the side as you are backing up, utilizing a flashing visual indicator in your side mirror and an audible warning.

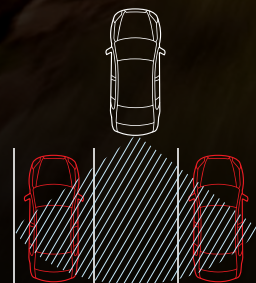

Rear-Vision Camera

Before you can avoid danger, you have to see it coming. The Outback features a standard Rear-Vision Camera that gives you a clearer view of the area behind your vehicle, so you can be in charge of your surroundings.



Blind-Spot Detection

Using radar sensors, the new Blind-Spot Detection system warns you with a visual indicator in each side mirror if a vehicle is sensed in your blind spots. Another feature of this system, **Lane Change Assist**, alerts you with a flashing indicator in each side mirror if it senses a vehicle approaching in a neighboring lane while you signal for a lane change.

¹ Always wear seatbelts. Children should be properly restrained in the rear seat.

² Blind-Spot Detection, Lane Change Assist and Rear Cross-Traffic Alert are systems designed to assist the driver by monitoring the rear and side areas of the vehicle during a lane change or reversing and are not a substitute for safe and attentive driving.

“This new fifth generation of the **Outback** impresses with not just an abundance of utility, but a newfound level of class within the spacious cabin.”

Edmunds.com, July 2014

“Subaru’s Symmetrical all-wheel-drive system is as blissful and invisible as always, serving up perfect amounts of grip to all four corners.”

Autoblog.com, July 2014

“In fact, there’s little the **2015 Subaru Outback** doesn’t handle with ease.”

Automobilemag.com, June 2014



Outback 2.5i Premium in Twilight Blue Metallic with optional and accessory equipment.

2015 Outback | Trim Levels



2.5i

- 175-hp 2.5-liter 4-cylinder SUBARU BOXER® engine
- Subaru Symmetrical All-Wheel Drive with Active Torque Vectoring and X-MODE®
- Infotainment system with 6.2-inch high-resolution LCD touchscreen display, HD Radio®, USB port/iPod® control, Bluetooth® audio streaming, 4-speaker AM/FM/CD player, hands-free phone and text messaging connectivity, 3.5-mm auxiliary jack and SUBARU STARLINK™ system with iHeartRadio®, Aha™ infotainment and Pandora® smartphone integration¹
- Cloth upholstery
- 6-way manually adjustable driver’s seat. 4-way manually adjustable front-passenger’s seat.
- Manually adjustable CFC-free air conditioning system with air filtration
- In-dash and cargo area 12-volt power outlets
- Cargo-area tray, tie-down and grocery bag hooks
- Lineartronic® CVT (Continuously Variable Transmission) with 6-speed manual-mode paddle shifters
- 17-inch steel wheels with covers
- Welcome lighting



2.5i Premium

Includes 2.5i key features and adds:

- Upgraded Infotainment system with 7.0-inch high-resolution LCD touchscreen display and voice-activated controls, 6-speaker AM/FM/CD player with HD Radio®, dual USB ports, SiriusXM® Satellite Radio², Bluetooth® audio streaming, hands-free phone and text messaging connectivity, 3.5-mm auxiliary jack and SUBARU STARLINK™ system with iHeartRadio®, Aha™ infotainment and Pandora® smartphone integration¹
- 17-inch aluminum-alloy wheels
- Fog lights (Steering Responsive Fog Lights on models equipped with optional EyeSight® driver assist technology)
- 10-way power adjustable driver’s seat. 4-way manually adjustable front-passenger’s seat.
- All-Weather Package: Heated exterior mirrors, 3-mode heated front seats, windshield wiper de-icer
- Dual-zone automatic climate control system
- Leather-wrapped steering wheel and shifter handle
- Driver’s and front-passenger’s auto-up/down power windows
- Electroluminescent gauges with LCD color display



2.5i Limited

Includes 2.5i Premium key features and adds:

- Premium audio system with 12 Harman Kardon GreenEdge® speakers, including center dash speaker and subwoofer, Harman Kardon 576-watt equivalent GreenEdge® amplifier
- Blind-Spot Detection with Lane Change Assist and Rear Cross-Traffic Alert³
- 18-inch machine finish 2-tone aluminum-alloy wheels
- Power rear gate with height memory
- All-Weather Package: Heated exterior mirrors, 3-mode heated front seats and dual mode heated rear seats, windshield wiper de-icer
- Leather-trimmed upholstery
- 10-way power adjustable driver’s seat with 2-position memory. 4-way power adjustable front-passenger’s seat.
- Woodgrain-patterned matte finish accent trim
- Side mirrors with integrated turn signals



3.6R Limited

Includes 2.5i Limited key features and adds:

- 256-hp 3.6-liter 6-cylinder SUBARU BOXER® engine
- HID low-beam headlights
- Lineartronic® HCVT (High-Torque Continuously Variable Transmission) with 6-speed manual-mode paddle shifters
- Dual exhaust outlets

¹ Compatible smartphone and applications required. For applications to operate, latest version of each application is required. Data provided by smartphone is displayed on the audio system screen. Some state laws prohibit the operation of handheld electronic devices while operating a vehicle. Smartphone apps should only be launched when vehicle is safely parked. Your wireless carrier’s rates may apply.

² Activation and required monthly subscription sold separately. Includes 4-month trial subscription. See your retailer.

³ Blind-Spot Detection, Lane Change Assist and Rear Cross-Traffic Alert are systems designed to assist the driver by monitoring the rear and side areas of the vehicle during a lane change or reversing and are not a substitute for safe and attentive driving.

2015 Outback | Specifications

| Engine and Drivetrain | | 2.5i | 3.6R |
|---------------------------------------|--|------------------------------|------------------|
| Power Torque | 2.5-liter DOHC aluminum-alloy 16-valve 4-cylinder horizontally opposed SUBARU BOXER® engine with Active Valve Control System. 175 hp @ 5,800 rpm 174 lb-ft @ 4,000 rpm | ● | — |
| | 3.6-liter DOHC aluminum-alloy 24-valve 6-cylinder horizontally opposed SUBARU BOXER® engine with Dual Active Valve Control System. 256 hp @ 6,000 rpm 247 lb-ft @ 4,400 rpm | — | ● |
| Automatic Transmission | Lineartronic® CVT (Continuously Variable Transmission) with Adaptive Control, Hill Holder®, Incline Start Assist and 6-speed manual mode with paddle shifters. | ● | — |
| | Lineartronic® HCVT (High-Torque Continuously Variable Transmission) with Adaptive Control, Hill Holder®, Incline Start Assist and 6-speed manual mode with paddle shifters. | — | ● |
| CA Emissions | | LEV III/SULEV30 ¹ | LEV III/ULEV 125 |
| Traction and Stability | | | |
| All-Wheel Drive type | Subaru Symmetrical All-Wheel Drive | ● | ● |
| X-MODE® | X-MODE® optimizes engine output and transmission ratio, increases all-wheel drive system engagement and uses enhanced control of the VDC system to reduce individual wheelspin, providing optimal traction on low friction surfaces. | ● | ● |
| Hill Descent Control (HDC) | X-MODE® also incorporates Hill Descent Control that helps to maintain a constant vehicle speed when traveling downhill, enhancing vehicle control. | ● | ● |
| Vehicle Dynamics Control (VDC) | Standard VDC electronic stability control utilizes sensors which constantly monitor wheel speeds, steering angle, brake pressure, vehicle yaw rate and lateral g-forces. If VDC detects a difference between the driver's intended path and the one the vehicle is actually taking, VDC applies braking power and/or reduces engine torque to help correct vehicle path. | ● | ● |
| Active Torque Vectoring | Active Torque Vectoring works in tandem with VDC applying braking power to the inside front wheel resulting in better handling, sharper turn-in, more neutral steering and higher cornering limits when turning. | ● | ● |
| Traction Control System (TCS) | VDC also incorporates an all-wheel, all-speed traction control system which senses a loss of traction and applies braking force to the slipping wheel or wheels as necessary to maintain vehicle motion. | ● | ● |
| Fuel | | | |
| Economy | city/highway/combined ² | 25/33/28 mpg | 20/27/22 mpg |
| Fuel Requirement | Unleaded gasoline (87 octane) | ● | ● |
| Fuel Capacity | 18.5 gallons | ● | ● |

2015 Outback | Specifications

| Chassis | | 2.5i | 3.6R |
|---------------------------------|--|------|------|
| Steering | Electric power-assisted quick ratio rack-and-pinion. Turning circle: 36.1 feet. | ● | ● |
| Suspension | 4-wheel independent. Front: MacPherson strut type. Stabilizer bar. Rear: Double-wishbone. Stabilizer bar. | ● | ● |
| Brakes | 4-wheel disc. Ventilated front and rear. 4-channel, 4-sensor ABS with Electronic Brake-force Distribution (EBD) | ● | ● |
| Brake Discs (front/rear) | 12.4 inches/11.8 inches | ● | ● |
| Brake Assist | When emergency braking is detected by how quickly the brake pedal is pressed, maximum brake pressure is immediately applied. | ● | ● |
| Brake Override System | If both brake and accelerator pedals are pressed simultaneously, the system reduces the operation of the accelerator pedal to help prevent unintentional vehicle acceleration. | ● | ● |
| Wheels and Tires | | | |
| Wheels | 2.5i: 17 x 7.0-inch steel with wheel covers | ● | — |
| | 2.5i Premium: 17 x 7.0-inch aluminum-alloy. Silver finish. 2.5i Limited and 3.6R Limited: 18 x 7.0-inch aluminum-alloy. Gray with machine finish. | ● | ● |
| Tires | 2.5i and 2.5i Premium: 225/65 R17 102H All-season | ● | — |
| | 2.5i Limited and 3.6R Limited: 225/60 R18 100H All-season | ● | ● |
| Spare Tire | Temporary use T155/80 R17 | ● | ● |

2015 Outback | Equipment

| Exterior | 2.5i | 2.5i Premium | 2.5i Limited | 3.6R Limited |
|---|------|----------------|----------------|----------------|
| Projector-beam low-beam and multireflector high-beam halogen headlights | ● | ● | ● | — |
| HID low-beam and multireflector high-beam halogen headlights | — | — | — | ● |
| Fog lights | — | ● | ● | ● |
| Steering-responsive fog lights (when equipped with optional EyeSight® driver assist system) | — | ○ | ○ | ○ |
| Black folding side mirrors | ● | — | — | — |
| Body-color folding side mirrors | — | ● | — | — |
| Body-color folding side mirrors with integrated turn signals | — | ○ ³ | ● | ● |
| Heated side mirrors and windshield wiper de-icer (All-Weather Package) | — | — | ● | ● |
| Power tilt/sliding-glass moonroof (96% UV light reducing) | — | ○ ⁴ | ○ ⁴ | ○ ⁴ |
| Roof rails with retractable cross bars and tie-downs | ● | ● | ● | ● |

Seating and Trim

| | | | | |
|---|---|---|---|---|
| 6-way manually adjustable driver's seat. 4-way manually adjustable front-passenger's seat. | ● | — | — | — |
| 10-way power adjustable driver's seat with power adjustable lumbar support. 4-way manually adjustable front-passenger's seat. | — | ● | — | — |
| 10-way power adjustable driver's seat with 2-position memory and power adjustable lumbar support. 4-way power front-passenger's seat. | — | — | ● | ● |
| Heated front seats (All-Weather Package) | — | ● | — | — |
| Heated front and rear seats (All-Weather Package) | — | — | ● | ● |
| 60/40-split flat-folding rear seatbacks | ● | ● | ● | ● |
| Leather-wrapped steering wheel | — | ● | ● | ● |
| Leather-wrapped shifter handle | — | ● | ● | ● |
| Cloth upholstery | ● | ● | — | — |
| Leather-trimmed upholstery | — | — | ● | ● |
| Silver metallic accent trim with knurled finish on dash and doors | ● | ● | — | — |
| Woodgrain-patterned accent trim on dash and doors | — | — | ● | ● |

Convenience Features

| | | | | |
|---|---|----------------|----------------|----------------|
| Power rear gate with automatic close and height memory | — | ○ ⁴ | ● | ● |
| Welcome lighting (when approaching or departing vehicle) | ● | ● | ● | ● |
| Electronic parking brake with Hill Holder® function | ● | ● | ● | ● |
| Auto-on/off headlights | ● | ● | ● | ● |
| Auto-dimming rearview compass mirror with HomeLink® | — | ○ ⁴ | ○ ⁴ | ○ ⁴ |
| Driver's and front-passenger's auto-up/down power windows | — | ● | ● | ● |
| Electronic cruise control (adaptive cruise control available with optional EyeSight® driver assist system) | ● | ● | ● | ● |
| 3-spoke steering wheel with audio system, cruise control and Bluetooth® buttons | ● | — | — | — |
| Leather-wrapped 3-spoke steering wheel with audio system, Bluetooth®, cruise control or (if equipped) EyeSight® adaptive cruise control buttons | — | ● | ● | ● |
| Dual USB ports | — | ● | ● | ● |
| Manually adjustable tilt/telescoping steering column | ● | ● | ● | ● |
| 8 cup holders | ● | ● | ● | ● |
| Overhead console with dual maplights | ● | ● | ● | ● |
| Cargo-area underfloor storage tray | ● | ● | ● | ● |

Audio and Communication Systems

| | | | | |
|--|---|---|---|---|
| Infotainment system with 6.2-inch high-resolution LCD touchscreen display, 4-speaker AM/FM/CD player with HD Radio®, USB port/iPod® control, Bluetooth® audio streaming, hands-free phone and text messaging connectivity, 3.5-mm auxiliary jack and SUBARU STARLINK™ system with iHeartRadio®, Aha™ infotainment and Pandora® smartphone integration ⁵ | ● | — | — | — |
| Upgraded Infotainment system with 7.0-inch high-resolution LCD touchscreen display and voice-activated controls, 6-speaker AM/FM/CD player with HD Radio®, dual USB ports, SiriusXM® Satellite Radio, ⁶ Bluetooth® audio streaming, hands-free phone and text messaging connectivity, 3.5-mm auxiliary jack and SUBARU STARLINK™ system with iHeartRadio®, Aha™ infotainment and Pandora® smartphone integration ⁵ | — | ● | ● | ● |
| Premium audio system with 12 Harman Kardon GreenEdge® speakers, including center dash speaker and subwoofer, 576-watt equivalent Harman Kardon GreenEdge® amplifier | — | — | ● | ● |

Climate Control

| | | | | |
|---|---|---|---|---|
| Manually adjustable CFC-free air-conditioning system with controls for temperature, fan and airflow direction | ● | — | — | — |
| Dual-zone automatic digital climate control system with controls for temperature, fan, airflow direction, dual-zone lockout and CFC-free air conditioning | — | ● | ● | ● |

2015 Outback | Equipment

| Instrumentation | 2.5i | 2.5i Premium | 2.5i Limited | 3.6R Limited |
|---|------|--------------|--------------|--------------|
| Analog speedometer, tachometer, coolant temperature and fuel level gauges. LCD color screen displaying vehicle functions. | ● | — | — | — |
| Electroluminescent analog speedometer, tachometer, coolant temperature and fuel level gauges. LCD color screen displaying enhanced vehicle functions. | — | ● | ● | ● |
| Security | | | | |
| Keyless entry system with answer-back electronic chirp | ● | ● | ● | ● |
| Antitheft security system with engine immobilizer | ● | ● | ● | ● |

Safety

| ACTIVE | | | | |
|--|---|----------------|---|---|
| Subaru Symmetrical All-Wheel Drive (AWD) | ● | ● | ● | ● |
| EyeSight® Driver Assist System ^{4,7} | — | ○ | ○ | ○ |
| Blind-Spot Detection with Lane Change Assist and Rear Cross-Traffic Alert ⁸ | — | ○ ⁴ | ● | ● |
| Vehicle Dynamics Control (VDC) | ● | ● | ● | ● |
| Traction Control System (TCS) | ● | ● | ● | ● |
| 4-wheel antilock braking system (ABS) with Electronic Brake-force Distribution (EBD) | ● | ● | ● | ● |
| Brake Assist | ● | ● | ● | ● |
| Rear-Vision Camera (hi-resolution) | ● | ● | ● | ● |
| PASSIVE | | | | |
| Subaru advanced frontal airbag system with driver's and front-passenger's front airbags (SRS) ⁹ | ● | ● | ● | ● |
| Driver and front-passenger seat cushion airbags (SRS) ⁹ | ● | ● | ● | ● |
| Side-curtain airbags with roll over sensor protecting front and rear outboard occupants (SRS) ⁹ | ● | ● | ● | ● |
| Seat-mounted front side-impact airbags (SRS) ⁹ | ● | ● | ● | ● |
| Whiplash-protection front seats | ● | ● | ● | ● |
| Height-adjustable front-seat head restraints | ● | ● | ● | ● |
| Height-adjustable 3-point front seatbelts with pretensioners and force limiters | ● | ● | ● | ● |
| 3-point seatbelts at all rear seating positions | ● | ● | ● | ● |
| LATCH system: Lower Anchors and Tethers for Children | ● | ● | ● | ● |

Optional Equipment

| | | | | |
|--|---|---|---|---|
| Power Rear Gate • Power Moonroof Package | — | ○ | — | — |
| Navigation Infotainment System • Power Rear Gate • Power Moonroof Package | — | ○ | — | — |
| EyeSight® Driver Assist System ⁷ • Blind-Spot Detection with Lane Change Assist and Rear Cross-Traffic Alert ⁸ • Power Rear Gate | — | ○ | — | — |
| Navigation Infotainment System • EyeSight® Driver Assist System ⁷ • Blind-Spot Detection with Lane Change Assist and Rear Cross-Traffic Alert ⁸ • Power Rear Gate • Power Moonroof Package | — | ○ | — | — |
| Keyless Access with Push-button Start • Navigation Infotainment System • Power Moonroof Package | — | — | ○ | ○ |
| Keyless Access with Push-button Start • Navigation Infotainment System • EyeSight® Driver Assist System ⁷ • Power Moonroof Package | — | — | ○ | ○ |

EQUIPMENT CONTENTS

Power Moonroof Package: Power tilt/sliding-glass moonroof and auto-dimming rearview compass mirror with HomeLink®

Navigation Infotainment System: Voice-activated 7-inch multi-touch gesture high-resolution GPS navigation system with integrated audio system, SiriusXM® Satellite Radio,⁶ NavTraffic®⁶ NavWeather®⁶ USB port/iPod® control, Bluetooth® audio streaming, hands-free phone and text messaging connectivity, 3.5-mm auxiliary jack and SUBARU STARLINK™ system with iHeartRadio®, Aha™ infotainment and Pandora® smartphone integration.⁵ Voice activation for Navigation, Phone, Audio System, and Climate Control system

EyeSight® Driver Assist System⁷: Pre-Collision Braking System, Pre-Collision Throttle Management, Lane Departure and Sway Warning, Adaptive Cruise Control

● Standard ○ Optional — Not equipped □ Available retailer-installed accessory

1 2015 Outback 2.5i models achieving a Partial Zero Emission Vehicle (PZEV) rating by the California Air Resources Board are available in all 50 states. Only those registered in California, Connecticut, Maine, Maryland, Massachusetts, New Jersey, New York, Rhode Island and Vermont will be eligible for the 15 years/150,000 mile emission warranty. Delaware, Oregon, Pennsylvania and Washington vehicles are not covered under PZEV emissions control warranty. See your warranty maintenance booklet for additional information. 2 2015 EPA fuel economy estimates. Actual mileage may vary. 3 Requires optional Blind-Spot Detection with Lane Change Assist and Rear Cross-Traffic Alert. 4 Available only with other features. See Optional Equipment listing. 5 Compatible smartphone and applications required. For applications to operate, latest version of each application is required. Data provided by smartphone is displayed on the audio system screen. Some state laws prohibit the operation of handheld electronic devices while operating a vehicle. Smartphone apps should only be launched when vehicle is safely parked. Your wireless carrier's rates may apply. 6 Activation and required monthly subscription sold separately. Includes 4-month trial subscription. See your retailer. 7 EyeSight is a driver assist system which may not operate optimally under all driving conditions. The driver is always responsible for safe and attentive driving. System effectiveness depends on many factors such as vehicle maintenance, weather and road conditions. Pre-Collision Braking System is designed to provide automatic braking that either prevents a collision or reduces the severity of a frontal impacts. Pre-Collision Throttle Management is designed to reduce acceleration and minimize the severity of certain frontal impacts. Adaptive Cruise Control and Brake Light Recognition are designed to assist the driver and are not substitutes for safe and attentive driving. The Lane Departure and Sway Warning operates only when the lane markings are visible and its effectiveness depends on many factors. See Owner's Manual for complete details on system operation and limitations. Please remember to turn off EyeSight when going through a carwash. Available on select models beginning Fall 2014. 8 Blind-Spot Detection, Lane Change Assist and Rear Cross-Traffic Alert are systems designed to assist the driver by monitoring the rear and side areas of the vehicle during a lane change or reversing and are not a substitute for safe and attentive driving. 9 The Supplemental Restraint System (SRS) (airbags) affords the driver and the front passenger additional protection in moderate to severe frontal and side-impact collisions and outboard 2nd-row passengers additional protection in moderate to severe side-impact collisions. This system provides supplemental protection only, and seatbelts must be worn in order to avoid injuries to out-of-position occupants upon airbag deployment and to provide the best combined protection in a serious accident. Children should always be properly restrained in one of the rear seats. See Owner's Manual for recommended seating position.



All-weather Floor Mats. Custom-fitted, heavy-gauge protective mats. Help protect vehicle's carpet from sand, dirt and moisture. Not intended for use on top of carpeted floor mats.



Compartment Separator. Helps to separate cargo from the passenger area.



Rear Seatback Protectors. Provide additional protection to the rear seatbacks when lowering the seats to transport larger cargo. Use in conjunction with the Rear Cargo Tray.



Trailer Hitch. Heavy-duty rated at up to 3,000 lbs towing capacity and 200 lbs tongue weight. Hitch ball not included. Trailer brakes may be needed. 2.5i: 2,700 lbs; 3.6R: 3,000 lbs.



Rear Bumper Cover. Helps protect the upper surface of painted rear bumper from scratches and dings.



Body Side Moldings. Attractive color-matched moldings coordinate with the styling of the vehicle, while helping to protect doors from unsightly dings.



Wheel Arch Molding Kit. Black textured moldings help protect the wheel arch areas, while adding a rugged, yet classy look. The wheel arch moldings look great with the addition of the accessory Splash Guards.



Splash Guards. Help protect the vehicle's paint finish from stones and road grime.



Side Window Deflectors. Let the fresh air in while helping to keep the weather out. Deflector design includes integrated chrome insert to match window frame trim. Side Window Deflectors may not be legal in all states. Please check the laws of your state.



Auto-dimming Mirror with Compass and HomeLink®. Darkens when headlights are detected from behind the vehicle. Includes a compass and three integrated HomeLink® buttons that are programmable for most garage-door openers and other HomeLink®-compatible devices.



Remote Engine Starter. Allows vehicle to be started by pushing a button from the convenience of home or office (up to 400 feet away depending on obstructions) so that the vehicle interior is more comfortable upon entry. The start/stop button blinks to confirm the engine has started. A/T only.



Remote Engine Starter—Smart Engine Start. Allows the vehicle to be started at the push of a button from outside the vehicle. Preset the heating or air conditioner controls to help bring the interior temperature to a more comfortable level prior to entry. Smart Engine Start works in conjunction with the Keyless Access with Push-button Start system. Operating distance is up to 75 feet depending on vehicle obstructions. A/T only.

Protecting Your Investment

Once you're part of our family, we'll be there for you. Every Subaru comes with 24-hour roadside assistance for 3 years or 36,000 miles. If you have trouble on the road, a tow to the nearest Subaru retailer and other services are just a phone call away. And to protect you over the long haul, we offer Added Security®—extended service agreements and maintenance plans that will help protect your car for up to 7 years or 100,000 miles. They're the only mechanical and maintenance plans backed by Subaru of America, Inc., and because we've been backing them for more than 30 years, they're agreements you can trust. Your retailer has full coverage details.

Subaru Badge of Ownership

True commitment shows through. For Subaru owners, it shows in kayak scuffs and snowboard scratches. It can take the form of dog hair that just won't come out, fresh coats of dust, or extra coats of wax. For many, the Subaru Badge of Ownership lets them show their commitment to the life they live and the confidence that has inspired them to fully embrace it. Owners can order badges online for free, stick them on, and let everyone know how they experience the world. Which one will you get?



Warranties

| | | |
|--|---|---|
| New Car Limited Warranty | 3 years or 36,000 miles, whichever comes first. | |
| Powertrain Limited Warranty | 5 years or 60,000 miles, whichever comes first. | |
| Wear Item Limited Warranty | 3 years or 36,000 miles, whichever comes first. Repairs to the following items will also be covered under Wear Item Limited Warranty: | <ul style="list-style-type: none"> • Brake Pads • Wiper Blades • Clutch Linings • Transmitter Batteries |
| Rust Perforation Limited Warranty | 5 years, unlimited mileage. | |

Take a Guided Tour

It's the ultimate way to get to know the Outback on your terms. Get up close and personal with color configurators, videos, 360-views, interactive content and more. Available for your desktop, tablet, and on the iTunes® App Store for your iPad®.



Take the Outback Guided Tour Online at: tour.subaru.com/Outback2015

or

Download the free iPad App on iTunes at: tour.subaru.com/OutbackApp

2015 Outback | Dimensions

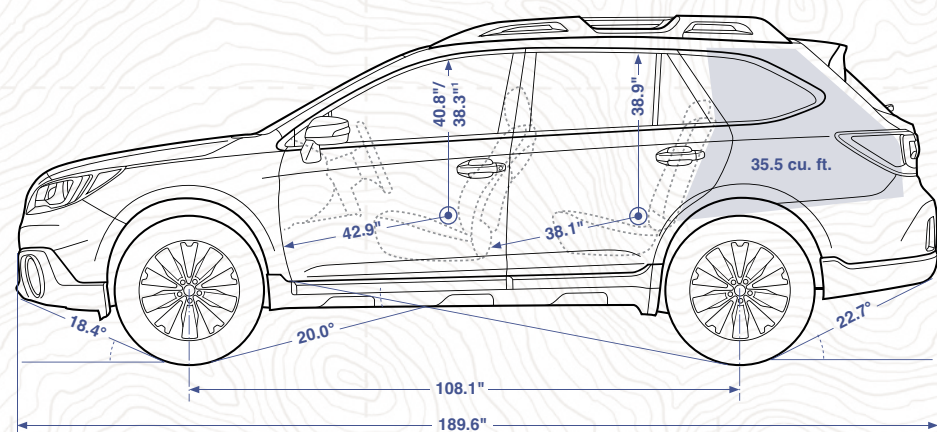
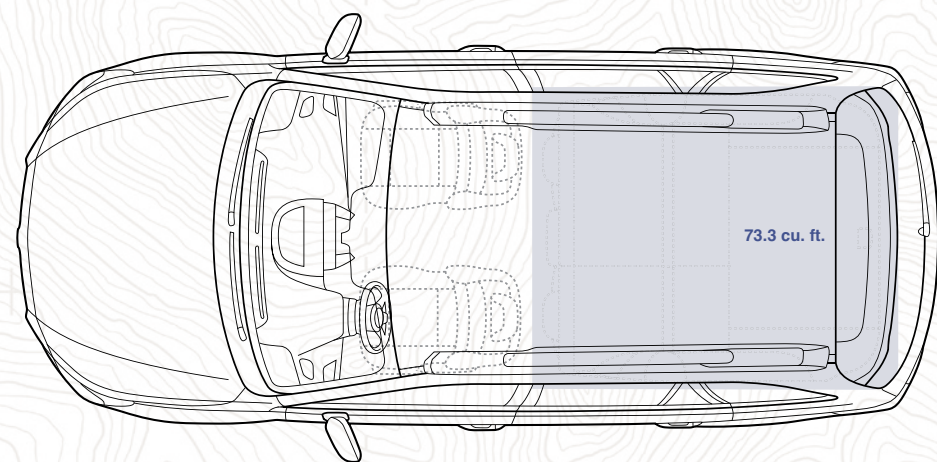

| | |
|---------------------------|--|
| Length | 189.6 inches |
| Width | 72.4 inches (81.3 inches/81.9 inches ² including mirrors) |
| Height | 66.1 inches |
| Wheelbase | 108.1 inches |
| Track (front/rear) | 61.8 inches/62.2 inches |
| Base curb weight | 2.5i: 3,593 lbs 2.5i Premium: 3,593 lbs 2.5i Limited: 3,633 lbs 3.6R Limited: 3,810 lbs |

| | |
|-----------------------------------|---|
| Ground clearance | 8.7 inches (at base curb weight) |
| Headroom (front/rear) | 40.8 inches/38.9 inches (with available moonroof: 38.3 inches/38.9 inches) |
| Legroom (front/rear) | 42.9 inches/38.1 inches |
| Shoulder room (front/rear) | 58.1 inches/57.3 inches |
| Hip room (front/rear) | 55.5 inches/55.0 inches |
| Passenger volume | 108.1 cubic feet (with available moonroof: 104.5 cubic feet) |
| Cargo volume | 35.5 cubic feet |
| Maximum cargo volume | 73.3 cubic feet with rear seatback folded |

¹ With available moonroof. Moonroof availability varies by trim level. ² With integrated turn signals.

Some images shown are for illustration purposes only. Specifications in this brochure are based on the latest product information available at the time of publication. For the most up-to-date and detailed product information, log on to www.subaru.com. Some equipment shown in photography in this brochure is optional at extra cost. Specific options may be available only in combination with other options. Specific combinations of equipment or features may vary from time to time and by geographic area. Certain accessories and equipment may not be available at the time of publication. Subaru of America, Inc., reserves the right to change or discontinue at any time, without notice, prices, colors, materials, equipment, accessories, specifications, models and packages without incurring any obligation to make the same or similar changes on vehicles previously sold. Colors shown may vary due to reproduction and printing processes.

This brochure was prepared by Subaru of America, Inc. A warranty from Subaru of America, Inc., is available only on cars sold to the first retail purchaser through an authorized Subaru retailer in the continental U.S. or Alaska. Every owner of the car during the warranty period shall be entitled to the benefit of these warranties. Subaru, SUBARU BOXER, Lineartronic, Added Security, Hill Holder and Outback are registered trademarks. Confidence in Motion and Starlink are trademarks of Fuji Heavy Industries, Ltd. EyeSight is a registered trademark of Fuji Heavy Industries, Ltd. Harman Kardon and GreenEdge are registered trademarks of HARMAN International Industries, Incorporated. Aha is a trademark of HARMAN International Industries, Incorporated. Bluetooth is a registered trademark of Bluetooth SIG, Inc. HD Radio is a registered trademark of iBiquity Digital Corporation. HomeLink is a registered trademark of Prince Corporation, a wholly owned subsidiary of Johnson Controls. Apple, iPod and iTunes are registered trademarks of Apple Inc. App Store is a service mark of Apple Inc. SiriusXM and NavTraffic are registered trademarks of SiriusXM Radio Inc. iHeartRadio is a registered trademark of Clear Channel Communications, Inc. Pandora is a registered trademark of Pandora Media, Inc. For more information, contact your Subaru retailer or log on to www.subaru.com.

2015 Outback | Colors

Paint



Crystal White Pearl

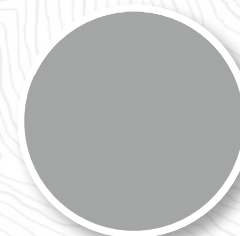

Ice Silver Metallic

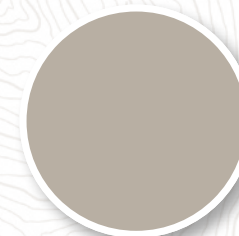

Tungsten Metallic

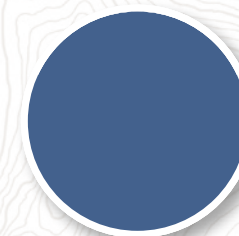

Twilight Blue Metallic

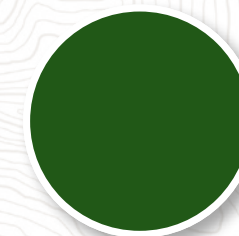

Wilderness Green Metallic

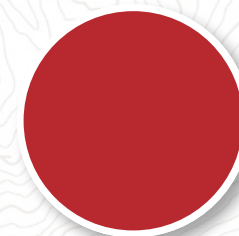

Venetian Red Pearl

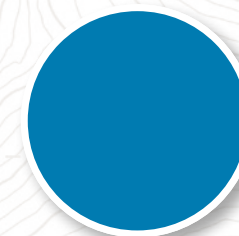

Lapis Blue Pearl

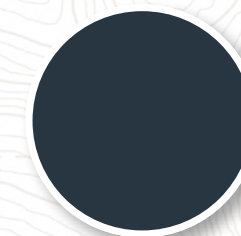

Carbide Gray Metallic

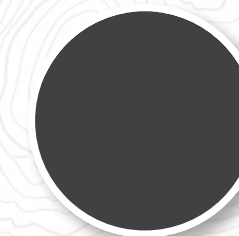

Crystal Black Silica

Upholstery



Slate Black Cloth (SBC)



Slate Black Leather (SBL)



Warm Ivory Cloth (WIC)

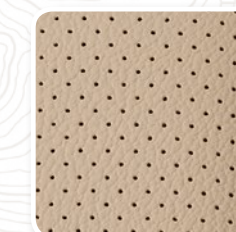

Warm Ivory Leather (WIL)

Color Combinations

| | 2.5i | 2.5i Premium | 2.5i Limited | 3.6R Limited |
|----------------------------------|------------|--------------|--------------|--------------|
| Crystal White Pearl | SBC or WIC | SBC or WIC | SBL or WIL | SBL or WIL |
| Ice Silver Metallic | SBC | SBC | SBL | SBL |
| Tungsten Metallic | WIC | WIC | WIL | WIL |
| Twilight Blue Metallic | SBC or WIC | SBC or WIC | SBL or WIL | SBL or WIL |
| Wilderness Green Metallic | WIC | WIC | WIL | WIL |
| Venetian Red Pearl | SBC or WIC | SBC or WIC | SBL or WIL | SBL or WIL |
| Lapis Blue Pearl | WIC | WIC | WIL | WIL |
| Carbide Gray Metallic | SBC | SBC | SBL | SBL |
| Crystal Black Silica | SBC or WIC | SBC or WIC | SBL or WIL | SBL or WIL |